

描述 / Descriptions

快恢复二极管，反向电压：50V~1000V，正向电流：1.0A，薄型 SMAF 封装。

Surface Mount Fast Recovery Rectifiers, Reverse Voltage : 50 to1000V,Forward Current:1.0A ,SMAF thin package.

特征 / Features

玻璃钝化芯片，反向恢复时间快，无铅符合欧盟 RoHS 指令 2011/65/EU，适用表面贴装。无卤产品。

Features: Glass Passivated Chip Junction, Fast reverse recovery time, Lead free in comply with EU ROHS 2011/65/EU directives, For surface mounted applications. Halogen free product.

用途 / Applications

一般用途。

General purpose.

内部等效电路 / Equivalent Circuit



引脚排列 / Pinning



PIN	DESCRIPTION
1	Cathode
2	Anode

The recommended mounting pad size

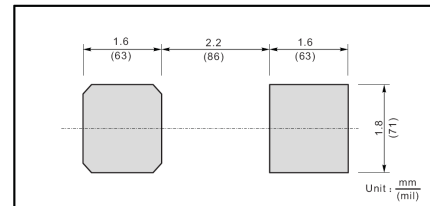

印章代码 / Marking

见印章说明。See Marking Instructions.

极限参数 / Absolute Maximum Ratings(Ta=25°C)

参数 Parameter	符号 Symbol	数值 Rating							单位 Unit
		RS1AF	RS1BF	RS1DF	RS1GF	RS1JF	RS1KF	RS1MF	
Maximum Repetitive Peak Reverse Voltage	V_{RRM}	50	100	200	400	600	800	1000	V
Maximum RMS voltage	V_{RMS}	35	70	140	280	420	560	700	V
Maximum DC Blocking Voltage	V_{DC}	50	100	200	400	600	800	1000	V
Maximum Average Forward Rectified Current at Ta = 65°C	$I_{F(AV)}$	1.0							A
Peak Forward Surge Current 8.3 ms Single Half Sine Wave Superimposed on Rated Load (JEDEC Method)	I_{FSM}	30							A
Typical Junction Capacitance ¹⁾	C_i	15							pF
Typical Thermal Resistance ²⁾	$R_{\theta JA}$	80							°C/W
Operating and Storage Temperature Range	T_j, T_{stg}	-55~+150							°C

Note:

- 1) Measured at 1MHz and applied reverse voltage of 4V D.C
- 2) P.C.B. mounted with 2.0" X 2.0" (5 X 5 cm) copper pad areas.

电性能参数 / Electrical Characteristics(Ta=25°C)

参数 Parameter	符号 Symbol	测试条件 Test Conditions	数值 Rating						单位 Unit	
			RS1AF	RS1BF	RS1DF	RS1GF	RS1JF	RS1KF		RS1MF
Maximum Instantaneous Forward Voltage	V_F	$I_F=1.0A$	1.3						V	
Maximum DC Reverse Current at Rated DC Blocking Voltage	I_R	$T_a=25^\circ C$	5.0						μA	
		$T_a=125^\circ C$	50						μA	
Maximum Reverse Recovery Time	t_{rr}	$I_F=0.5A$ $I_R=1.0A$ $I_{rr}=0.25A$	150			250		500		ns

电参数曲线图 / Electrical Characteristic Curve

Fig.1 Forward Current Derating Curve

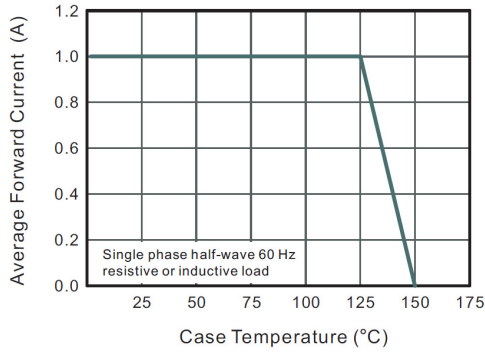

Fig.2 Typical Reverse Characteristics

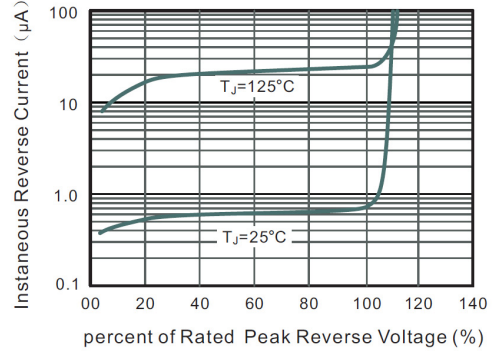

Fig.3 Typical Instantaneous Forward Characteristics

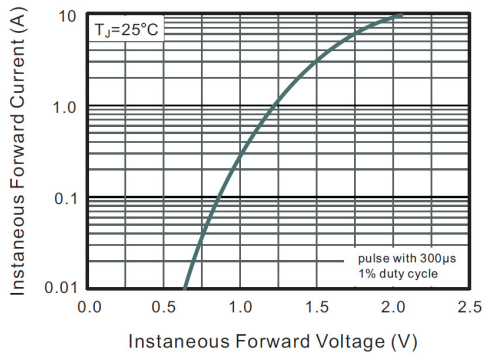

Fig.4 Typical Junction Capacitance

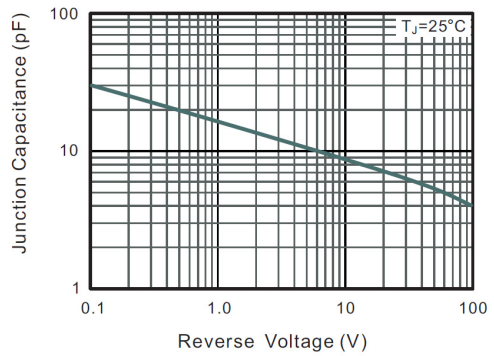
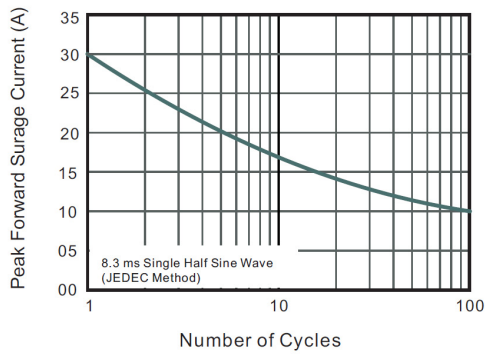
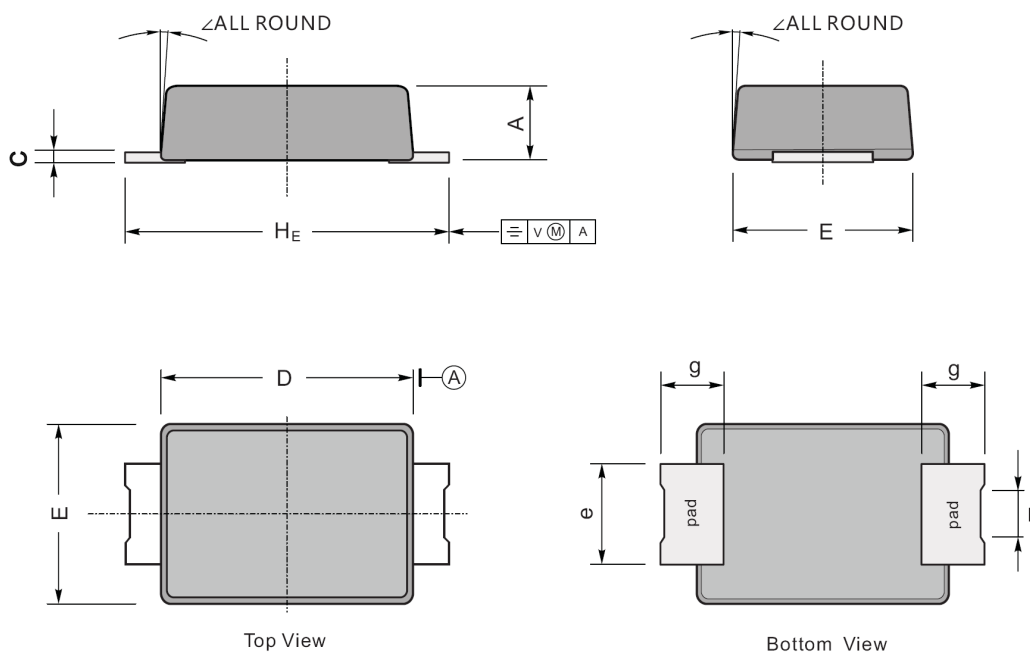

Fig.5 Maximum Non-Repetitive Peak Forward Surge Current



外形尺寸图 / Package Dimensions



UNIT		A	C	D	E	e	g	H_E	b	\angle
mm	max	1.2	0.20	3.7	2.7	1.6	1.2	4.9	1.05	7°
	min	0.9	0.12	3.3	2.4	1.3	0.8	4.4	0.65	
mil	max	47	7.9	146	106	63	47	193	41	
	min	35	4.7	130	94	51	31	173	26	

Marking

Type number	Marking code
RS1AF	RS1A
RS1BF	RS1B
RS1DF	RS1D
RS1GF	RS1G
RS1JF	RS1J
RS1KF	RS1K
RS1MF	RS1M

印章说明 / Marking Instructions



说明：

RS1A： 为型号代码

****： 为生产批号追溯码，第1个*为年月代码，后面3个*为当月小批号代码

Note:

RS1A： Product Type Code

****： Lot No. Code ,The 1st * means:YM Code ,The last 3 * means:little Lot No
Code

回流焊温度曲线图(无铅) / Temperature Profile for IR Reflow Soldering(Pb-Free)

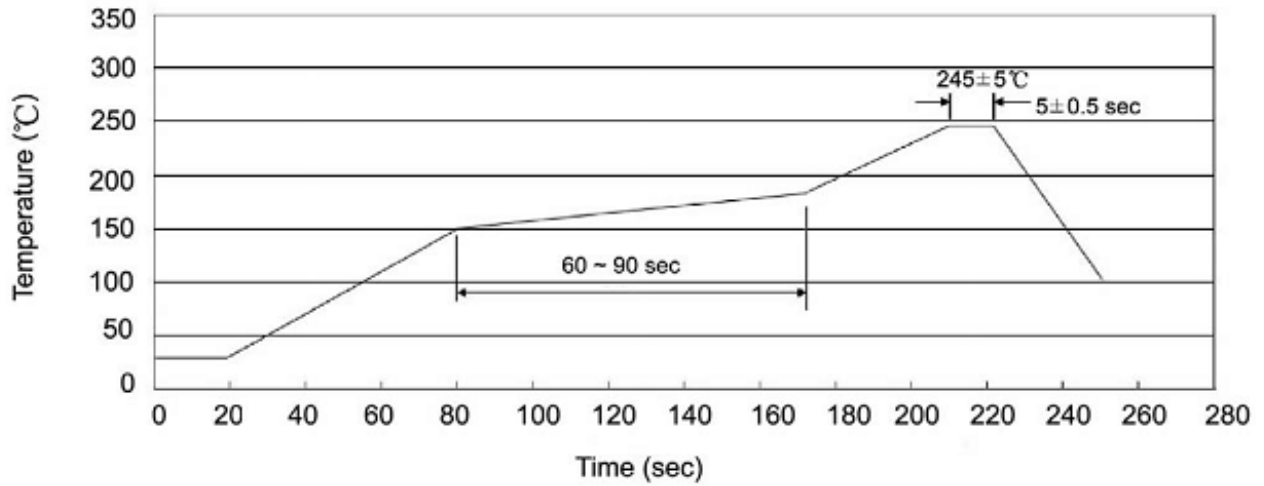

说明：

- 1、预热温度 150~180°C，时间 60~90sec；
- 2、峰值温度 245±5°C，时间持续为 5±0.5sec；
- 3、焊接制程冷却速度为 2~10°C/sec.

Note:

- 1.Preheating:150~180°C, Time:60~90sec.
- 2.Peak Temp.:245±5°C, Duration:5±0.5sec.
3. Cooling Speed: 2~10°C/sec.

耐焊接热试验条件 / Resistance to Soldering Heat Test Conditions

温度：260±5°C

时间：10±1 sec.

Temp.:260±5°C

Time:10±1 sec

包装规格 / Packaging SPEC.

卷盘包装 / REEL

Package Type 封装形式	Units 包装数量					Dimension 包装尺寸 (unit: mm ³)		
	Units/Reel 只/卷盘	Reels/Inner Box 卷盘/盒	Units/Inner Box 只/盒	Inner Boxes/Outer Box 盒/箱	Units/Outer Box 只/箱	Reel	Inner Box 盒	Outer Box 箱
SMAF	3000	5	15000	5	75000	7" ×11	185X180X105	390X385X205

使用说明 / Notices

X-ON Electronics

Largest Supplier of Electrical and Electronic Components

Click to view similar products for [Rectifiers](#) category:

Click to view products by [Blue Rocket](#) manufacturer:

Other Similar products are found below :

[70HFR40](#) [FR105 R0](#) [RL252-TP](#) [1N5397](#) [JANTX1N5634A](#) [1N4002G](#) [1N4005-TR](#) [JANS1N6640US](#) [481235F](#) [RRE02VS6SGTR](#) [067907F](#)
[MS306](#) [US2JFL-TP](#) [A1N5404G-G](#) [CRS12\(T5L,TEMQ\)](#) [ACGRB207-HF](#) [CLH07\(TE16L,Q\)](#) [CLH03\(TE16L,Q\)](#) [ACGRC307-HF](#)
[ACEFC304-HF](#) [DZ-1380](#) [NTE6356](#) [NTE6359](#) [JAN1N5555](#) [85HFR60](#) [40HFR60](#) [70HF120](#) [85HFR80](#) [D126A45C](#) [SCF7500](#) [SCHJ22.5K](#)
[SM100](#) [SCPA2](#) [SDHD5K](#) [ACGRA4001-HF](#) [D1821SH45T PR](#) [D1251S45T](#) [NTE6358](#) [NTE5850](#) [NTE5819](#) [NTE5837](#) [NTE5892](#) [NTE5900](#)
[NTE5911](#) [NTE5915](#) [NTE5921](#) [NTE6104](#) [NTE6105](#) [NTE6154](#) [NTE6158](#)