

### 描述 / Descriptions

快恢复二极管，反向电压：1000V，正向电流：3.0A，薄型 SMAF 封装。

Surface Mount Fast Recovery Rectifiers, Reverse Voltage : 1000V, Forward Current:3.0A ,SMAF thin package.

### 特征 / Features

玻璃钝化芯片，反向恢复时间快，无铅符合欧盟 RoHS 指令 2011/65/EU，适用表面贴装。无卤产品。

Glass Passivated Chip Junction, Fast reverse recovery time, Lead free in comply with EU RoHS 2011/65/EU directives, For surface mounted applications. Halogen free product.

### 用途 / Applications

一般用途.

General purpose.

### 内部等效电路 / Equivalent Circuit



### 引脚排列 / Pinning



PIN	DESCRIPTION
1	Cathode
2	Anode

The recommended mounting pad size

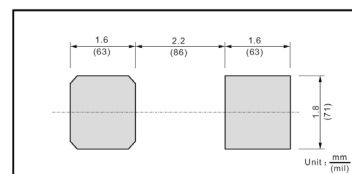

### 印章代码 / Marking

见印章说明。See Marking Instructions.

**极限参数 / Absolute Maximum Ratings(Ta=25°C)**

参数 Parameter	符号 Symbol	数值 Rating	单位 Unit
Maximum Repetitive Peak Reverse Voltage	$V_{RRM}$	1000	V
Maximum RMS voltage	$V_{RMS}$	700	V
Maximum DC Blocking Voltage	$V_{DC}$	1000	V
Maximum Average Forward Rectified Current at $T_c = 100^\circ\text{C}$	$I_{F(AV)}$	3.0	A
Peak Forward Surge Current 8.3 ms Single Half Sine Wave Superimposed on Rated Load (JEDEC Method)	$I_{FSM}$	80	A
Typical Junction Capacitance at <sup>1)</sup>	$C_j$	60	pF
Typical Thermal Resistance <sup>2)</sup>	$R_{\theta JA}$	50	$^\circ\text{C}/\text{W}$
Operating and Storage Temperature Range	$T_j, T_{stg}$	-55~+150	$^\circ\text{C}$

Note:

1) Measured at 1MHz and applied reverse voltage of 4V D.C.

2) P.C.B. mounted with 1.0 X 1.0" (2.54 X 2.54 cm) copper pad areas.

**电性能参数 / Electrical Characteristics(Ta=25°C)**

参数 Parameter	符号 Symbol	测试条件 Test Conditions	数值 Rating	单位 Unit
Maximum Instantaneous Forward Voltage	$V_F$	$I_F=3.0\text{A}$	1.3	V
Maximum DC Reverse Current at Rated DC Blocking Voltage	$I_R$	$T_a=25^\circ\text{C}$	5.0	$\mu\text{A}$
		$T_a=125^\circ\text{C}$	150	$\mu\text{A}$
Maximum Reverse Recovery Time	$t_{rr}$	$I_F=0.5\text{A}$ $I_R=1.0\text{A}$ $I_{rr}=0.25\text{A}$	200	ns

电参数曲线图 / Electrical Characteristic Curve

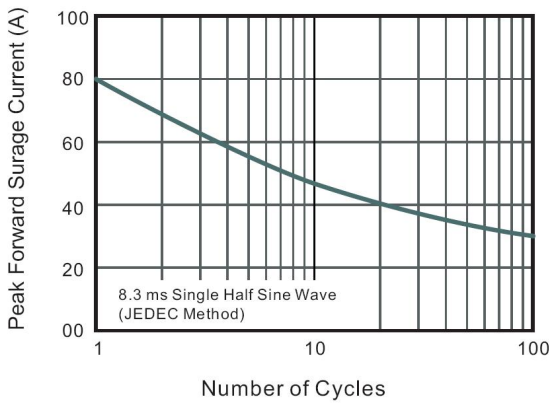
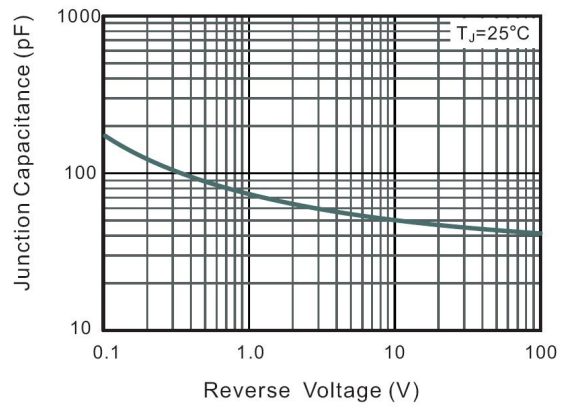
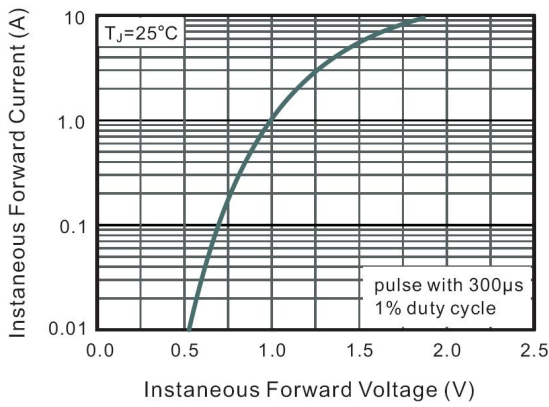
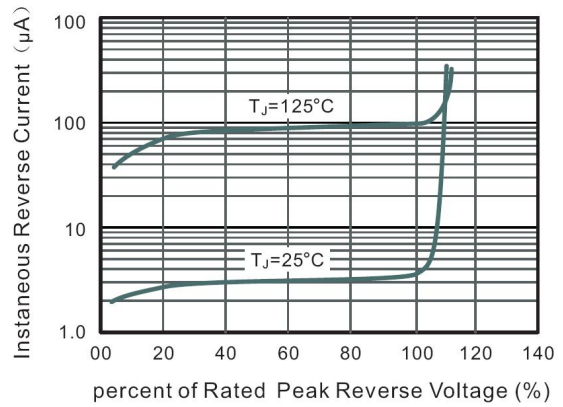
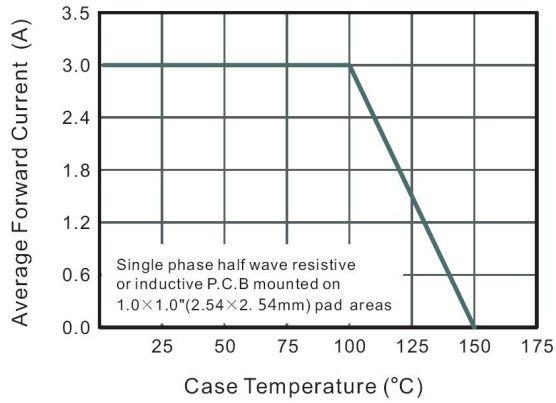

外形尺寸图 / Package Dimensions

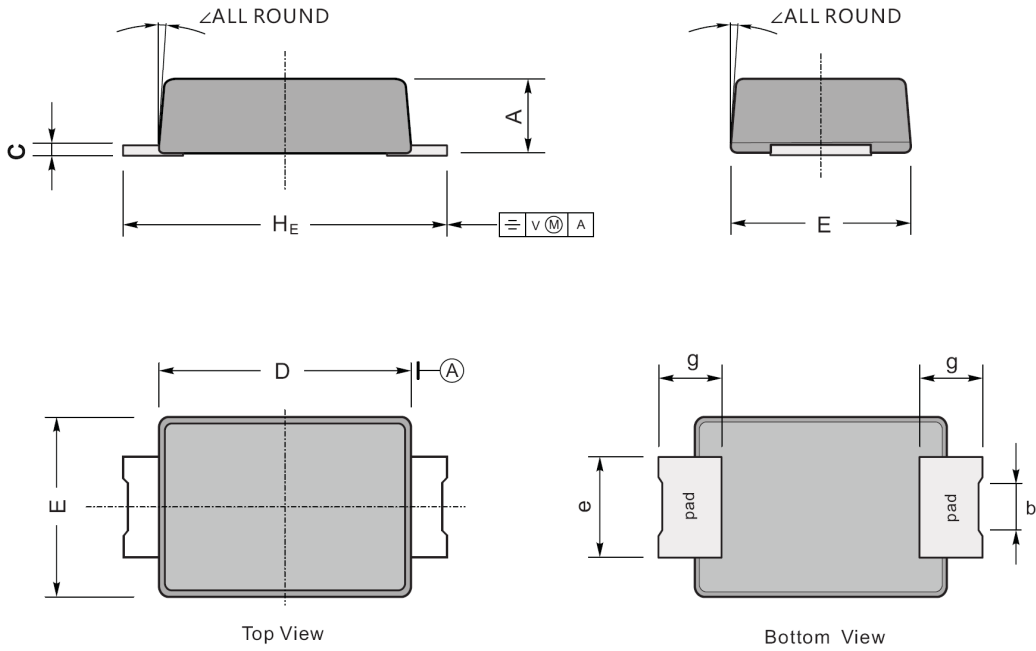

UNIT		A	C	D	E	e	g	$H_E$	b	$\angle$
mm	max	1.2	0.20	3.7	2.7	1.6	1.2	4.9	1.05	7°
	min	0.9	0.12	3.3	2.4	1.3	0.8	4.4	0.65	
mil	max	47	7.9	146	106	63	47	193	41	
	min	35	4.7	130	94	51	31	173	26	

印章说明 / Marking Instructions

Type number	Marking code
RS3MAF	R3MA-1

印章说明 / Marking Instructions

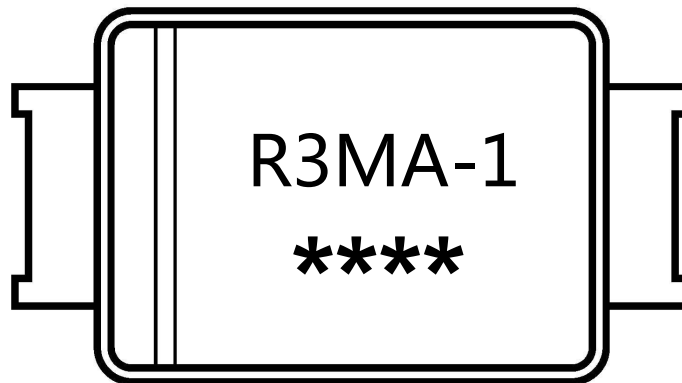

说明

R3MA-1 : 为型号代码

\*\*\*\* : 为生产批号追溯码，第1个\*为年月代码，后面3个\*为当月小批号代码

Note:

R3MA-1 : Product Type Code

\*\*\*\* : Lot No. Code , The 1st \* means:YM Code , The last 3 \* means:little  
Lot No Code

**回流焊温度曲线图(无铅) / Temperature Profile for IR Reflow Soldering(Pb-Free)**

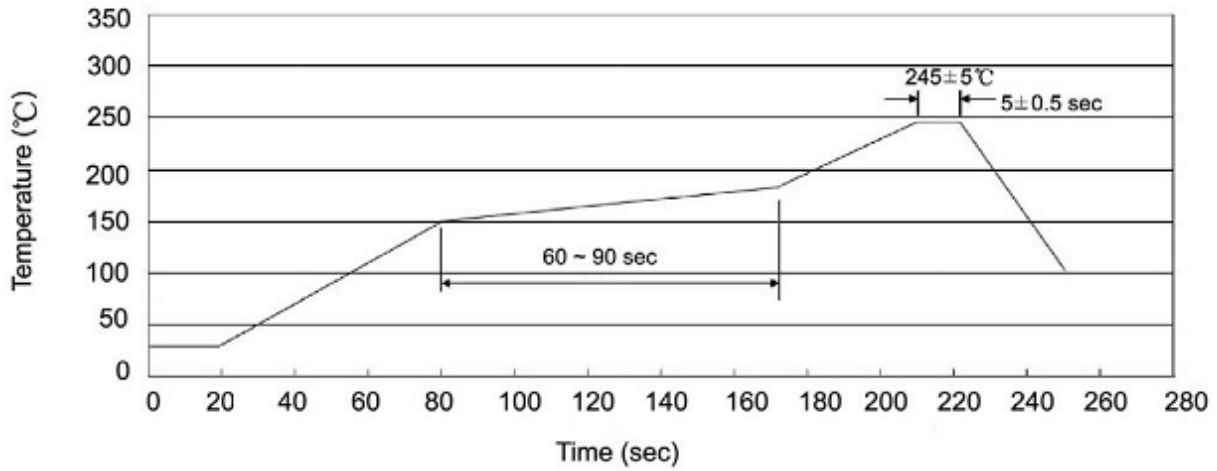

说明：

- 1、预热温度 150~180°C，时间 60~90sec;
- 2、峰值温度 245±5°C，时间持续为 5±0.5sec;
- 3、焊接制程冷却速度为 2~10°C/sec.

Note:

- 1.Preheating:150~180°C, Time:60~90sec.
- 2.Peak Temp.:245±5°C, Duration:5±0.5sec.
3. Cooling Speed: 2~10°C/sec.

**耐焊接热试验条件 / Resistance to Soldering Heat Test Conditions**

温度：260±5°C      时间：10±1 sec.      Temp.:260±5°C      Time:10±1 sec

**包装规格 / Packaging SPEC.**

卷盘包装 / REEL

Package Type 封装形式	Units 包装数量					Dimension 包装尺寸 (unit: mm <sup>3</sup> )		
	Units/Reel 只/卷盘	Reels/Inner Box 卷盘/盒	Units/Inner Box 只/盒	Inner Boxes/Outer Box 盒/箱	Units/Outer Box 只/箱	Reel	Inner Box 盒	Outer Box 箱
SMAF	3000	5	15000	5	75000	7" ×11	185X180X105	390X385X205

**使用说明 / Notices**

## X-ON Electronics

Largest Supplier of Electrical and Electronic Components

*Click to view similar products for [Rectifiers](#) category:*

*Click to view products by [Blue Rocket](#) manufacturer:*

Other Similar products are found below :

[70HFR40](#) [FR105 R0](#) [RL252-TP](#) [150KR30A](#) [1N5397](#) [1N4002G](#) [1N4005-TR](#) [UFS120Je3/TR13](#) [JANS1N6640US](#) [481235F](#)  
[RRE02VS6SGTR](#) [067907F](#) [MS306](#) [70HF40](#) [T110HF60](#) [T85HFL60S02](#) [US2JFL-TP](#) [A1N5404G-G](#) [CRS12\(T5L,TEMQ\)](#) [ACGRB207-HF](#)  
[CLH07\(TE16L,Q\)](#) [CLH03\(TE16L,Q\)](#) [ACGRC307-HF](#) [ACEFC304-HF](#) [NTE6356](#) [NTE6359](#) [85HFR60](#) [40HFR60](#) [70HF120](#) [85HFR80](#)  
[D126A45C](#) [SCF7500](#) [D251N08B](#) [SCHJ22.5K](#) [SM100](#) [SCPA2](#) [SDHD5K](#) [ACGRA4001-HF](#) [ACURA107-HF](#) [D1821SH45T PR](#) [D1251S45T](#)  
[NTE6358](#) [NTE5850](#) [NTE5819](#) [NTE5837](#) [NTE5892](#) [NTE5900](#) [NTE5911](#) [NTE5915](#) [NTE5921](#)