

描述 / Descriptions

表面贴装整流二极管，反向电压：50V~1000V，正向电流：2.0A，SMAF 封装。
Surface Mount General Purpose Silicon Rectifiers, Reverse Voltage: 50 to 1000V, Forward Current: 2.0A, SMAF package.

特征 / Features

玻璃钝化芯片，效率高，无铅符合欧盟 RoHS 指令 2011/65/EU，适用于表面贴装。无卤产品。
Glass Passivated Chip Junction, High efficiency, Lead free in comply with EU R0HS 2011/65/EU directives, For surface mounted applications. Halogen free product.

用途 / Applications

一般用途。
General purpose.

内部等效电路 / Equivalent Circuit



引脚排列 / Pinning



PIN	DESCRIPTION
1	Cathode
2	Anode

The recommended mounting pad size

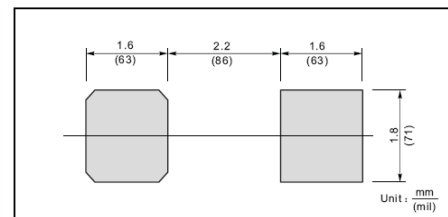

印章代码 / Marking

见印章说明。See Marking Instructions.

极限参数 / Absolute Maximum Ratings(Ta=25°C)

参数 Parameter	参数符号 Symbol	数值 Rating							单位 Unit
		S2AF	S2BF	S2DF	S2GF	S2JF	S2KF	S2MF	
Maximum Repetitive Peak Reverse Voltage	V_{RRM}	50	100	200	400	600	800	1000	V
Maximum RMS voltage	V_{RMS}	35	70	140	280	420	560	700	V
Maximum DC Blocking Voltage	V_{DC}	50	100	200	400	600	800	1000	V
Maximum Average Forward Rectified Current at $T_c = 125^\circ\text{C}$	$I_{F(AV)}$	2.0							A
Peak Forward Surge Current 8.3 ms Single Half Sine Wave Superimposed on Rated Load	I_{FSM}	50							A
Typical Junction Capacitance ¹⁾	C_j	22							pF
Typical Thermal Resistance ²⁾	$R_{\theta JA}$	65							°C/W
	$R_{\theta JC}$	20							
Operating and Storage Temperature Range	T_j, T_{stg}	-55~+150							°C

Note:

- 1) Measured at 1 MHz and applied reverse voltage of 4 V D.C
- 2) P.C.B. mounted with 2.0 X 2.0" (5 X 5 cm) copper pad areas.

电性能参数 / Electrical Characteristics(Ta=25°C)

参数 Parameter	参数符号 Symbol	测试条件 Test condition	数值 Rating	单位 Unit
Maximum Instantaneous Forward Voltage	V_F	$I_F=2.0A$	1.1	V
Maximum DC Reverse Current at Maximum DC Blocking Voltage	I_R	$T_a=25^\circ\text{C}$	5.0	uA
		$T_a=125^\circ\text{C}$	100	

电参数曲线图 / Electrical Characteristic Curve

Fig.1 Forward Current Derating Curve

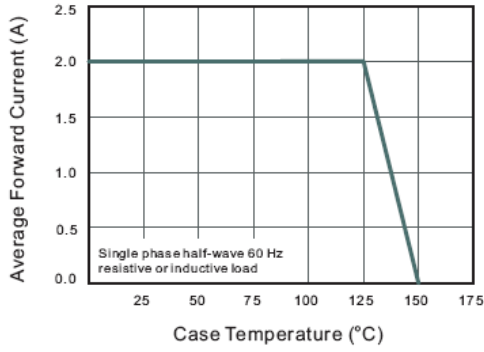

Fig.2 Typical Instaneous Reverse Characteristics

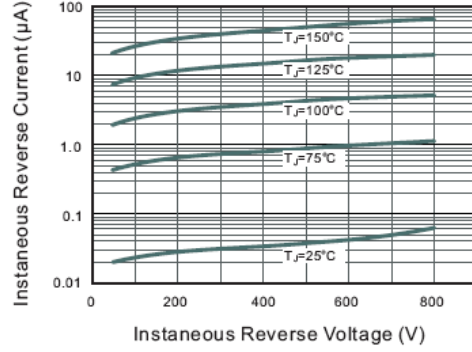

Fig.3 Typical Forward Characteristic

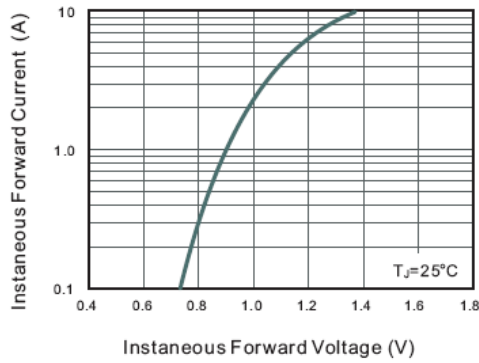

Fig.4 Typical Junction Capacitance

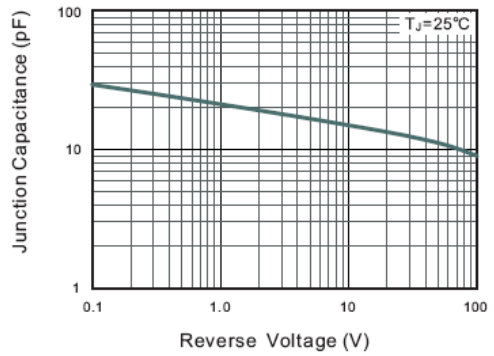
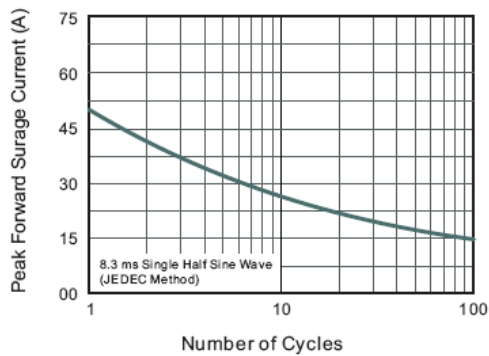
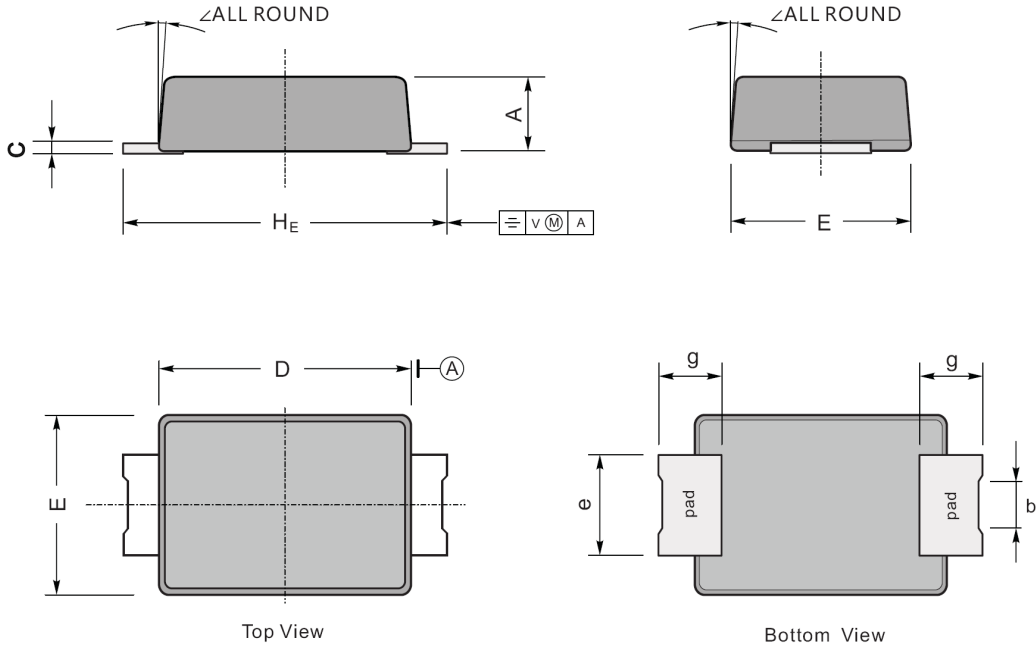

Fig.5 Maximum Non-Repetitive Peak Forward Surge Current



外形尺寸图 / Package Dimensions



UNIT		A	C	D	E	e	g	H _E	b	∠
mm	max	1.2	0.20	3.7	2.7	1.6	1.2	4.9	1.05	7°
	min	0.9	0.12	3.3	2.4	1.3	0.8	4.4	0.65	
mil	max	47	7.9	146	106	63	47	193	41	
	min	35	4.7	130	94	51	31	173	26	

Marking

Type number	Marking code
S2AF	S2A
S2BF	S2B
S2DF	S2D
S2GF	S2G
S2JF	S2J
S2KF	S2K
S2MF	S2M

印章说明 / Marking Instructions

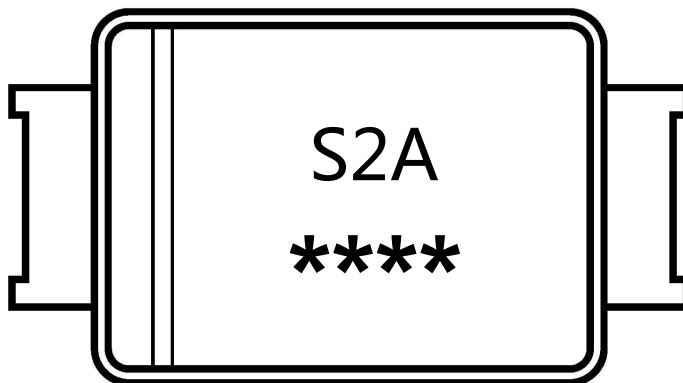

说明：

S2A： 为型号代码

****： 为生产批号追溯码，第1个*为年月代码，后面3个*为当月小批号代码

Note:

S2A： Product Type Code

****： Lot No. Code ,The 1st * means:YM Code ,The last 3 * means:little Lot No Code

回流焊温度曲线图(无铅) / Temperature Profile for IR Reflow Soldering(Pb-Free)

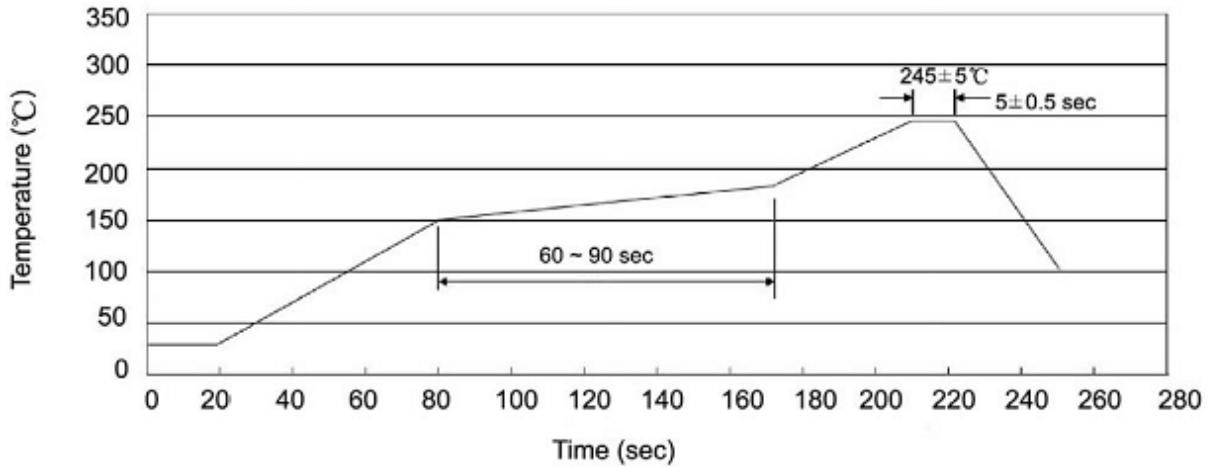

说明：

- 1、预热温度 150 ~ 180°C，时间 60 ~ 90sec;
- 2、峰值温度 245±5°C，时间持续为 5±0.5sec;
- 3、焊接制程冷却速度为 2 ~ 10°C/sec.

Note:

- 1.Preheating:150~180°C, Time:60~90sec.
- 2.Peak Temp.:245±5°C, Duration:5±0.5sec.
3. Cooling Speed: 2~10°C/sec.

耐焊接热试验条件 / Resistance to Soldering Heat Test Conditions

温度：260±5°C

时间：10±1 sec.

Temp.:260±5°C

Time:10±1 sec

包装规格 / Packaging SPEC.

卷盘包装 / REEL

Package Type 封装形式	Units 包装数量					Dimension 包装尺寸 (unit: mm ³)		
	Units/Reel 只/卷盘	Reels/Inner Box 卷盘/盒	Units/Inner Box 只/盒	Inner Boxes/Outer Box 盒/箱	Units/Outer Box 只/箱	Reel	Inner Box 盒	Outer Box 箱
SMAF	3000	5	15000	5	75000	7" ×11	185X180X105	390X385X205

使用说明 / Notices

X-ON Electronics

Largest Supplier of Electrical and Electronic Components

Click to view similar products for [Diodes - General Purpose, Power, Switching category:](#)

Click to view products by [Blue Rocket manufacturer:](#)

Other Similar products are found below :

[MCL4151-TR3](#) [MMBD3004S-13-F](#) [RD0306T-H](#) [1N3611](#) [NTE156A](#) [NTE574](#) [NTE6244](#) [1SS193,LF](#) [1SS400CST2RA](#) [SDAA13](#)
[SHN2D02FUTW1T1G](#) [LS4151GS08](#) [1N4449](#) [1N456A](#) [1N4934-E3/73](#) [1N914BTR](#) [RFUH20TB3S](#) [D291S45T](#) [BAV300-TR](#) [BAW56DWQ-](#)
[7-F](#) [BAW56M3T5G](#) [BAW75-TAP](#) [MM230L-CAA](#) [IDW40E65D1](#) [JAN1N3600](#) [JAN1N4454UR-1](#) [LL4151-GS18](#) [SMMSD4148T3G](#)
[BYW95B/A52A](#) [NSVDAN222T1G](#) [CDSZC01100-HF](#) [LL4150-M-08](#) [1N4454-TR](#) [BAV70HDW-7](#) [BAS28-7](#) [JANTX1N6640](#) [BAW56HDW-](#)
[13](#) [BAS28 TR](#) [VS-HFA04SD60STR-M3](#) [NSVM1MA152WKT1G](#) [1SS388-TP](#) [RGP30D-E3/73](#) [VS-8EWF02S-M3](#) [BAV99TQ-13-F](#)
[BAV99HDW-13](#) [MMDB30-E28X](#) [IDP20C65D2XKSA1](#) [LS4148](#) [IDV15E65D2](#) [NSVM1MA152WAT1G](#)