

# SS22B~SS220B

Rev.C Sep.-2020

## 描述 / Descriptions

表面贴装肖特基整流二极管，反向电压：20V~200V，正向电流：2.0A，SMB封装。

Surface Mount Schottky Barrier Rectifiers, Reverse Voltage : 20 to 200V, Forward Current: 2.0A, SMB package.

## 特征 / Features

低功耗，高效率，高正向浪涌电流能力，无铅符合欧盟 RoHS 指令 2011/65/EU，适用表面贴装。无卤产品。

Low power loss, high efficiency, High forward surge current capability, Lead free in comply with EU RoHS 2011/65/EU directives, For surface mounted applications. HF product.

## 用途 / Applications

一般用途。

General purpose.

## 内部等效电路 / Equivalent Circuit

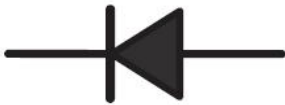

## 引脚排列 / Pinning

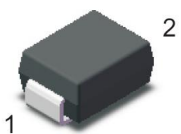

PIN	DESCRIPTION
1	Cathode
2	Anode

The recommended mounting pad size

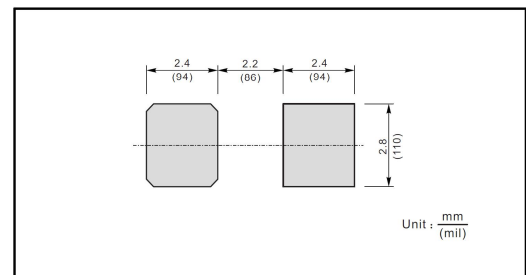

## 印章代码 / Marking

见印章说明。See Marking Instructions.

**极限参数 / Absolute Maximum Ratings(Ta=25°C)**

参数 Parameter	符号 Symbol	数值 Rating								单位 Unit
		SS22B	SS24B	SS26B	SS28B	SS210B	SS212B	SS215B	SS220B	
Maximum Repetitive Peak Reverse Voltage	$V_{RRM}$	20	40	60	80	100	120	150	200	V
Maximum RMS voltage	$V_{RMS}$	14	28	42	56	70	84	105	140	V
Maximum DC Blocking Voltage	$V_{DC}$	20	40	60	80	100	120	150	200	V
Maximum Average Forward Rectified Current	$I_{F(AV)}$	2.0								A
Peak Forward Surge Current 8.3 ms Single Half Sine Wave Superimposed on Rated Load (JEDEC Method)	$I_{FSM}$	55			45					A
Typical Junction Capacitance at	$C_j$	220			110					pF
Typical Thermal Resistance <sup>1)</sup>	$R_{\theta JA}$	60								°C/W
Operating Junction Temperature Range	$T_j$	-55~+150								°C
Storage Temperature Range	$T_{stg}$	-55~+150								°C

Note:

1) P.C.B. mounted with 2.0 X 2.0" (5 X5 cm) copper pad areas.

**电性能参数 / Electrical Characteristics(Ta=25°C)**

参数 Parameter	符号 Symbol	测试条件 Test Conditions	数值 Rating								单位 Unit
			SS22B	SS24B	SS26B	SS28B	SS210B	SS212B	SS215B	SS220B	
Maximum Instantaneous Forward Voltage	$V_F$	$I_F=2.0A$	0.55		0.70	0.85			0.95	V	
Maximum DC Reverse Current at Rated DC Blocking Voltage	$I_R$	$T_a=25^\circ C$	0.5			0.3				mA	
		$T_a=100^\circ C$	5.0			3.0				mA	

电参数曲线图 / Electrical Characteristic Curve

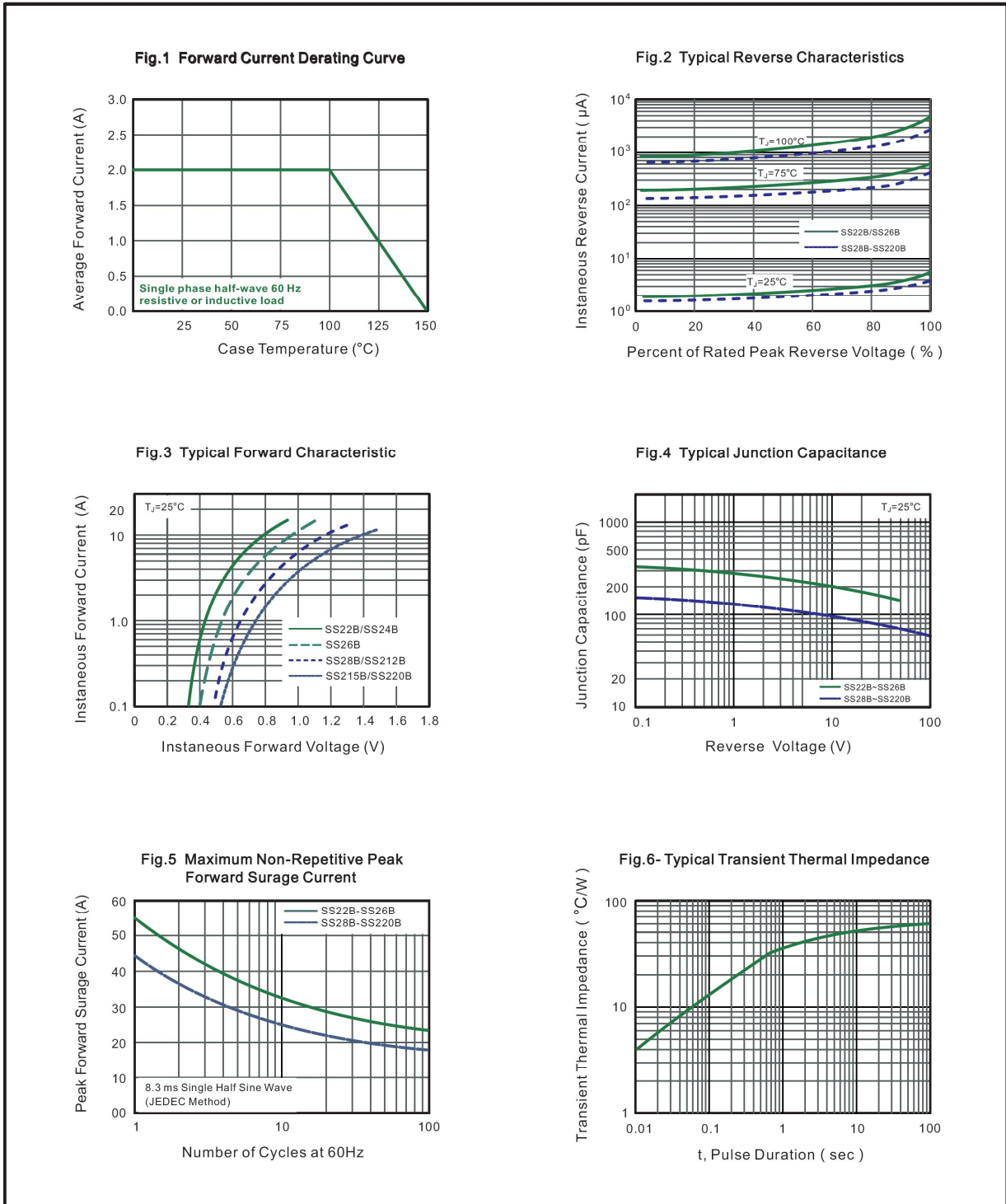

外形尺寸图 / Package Dimensions

SMB

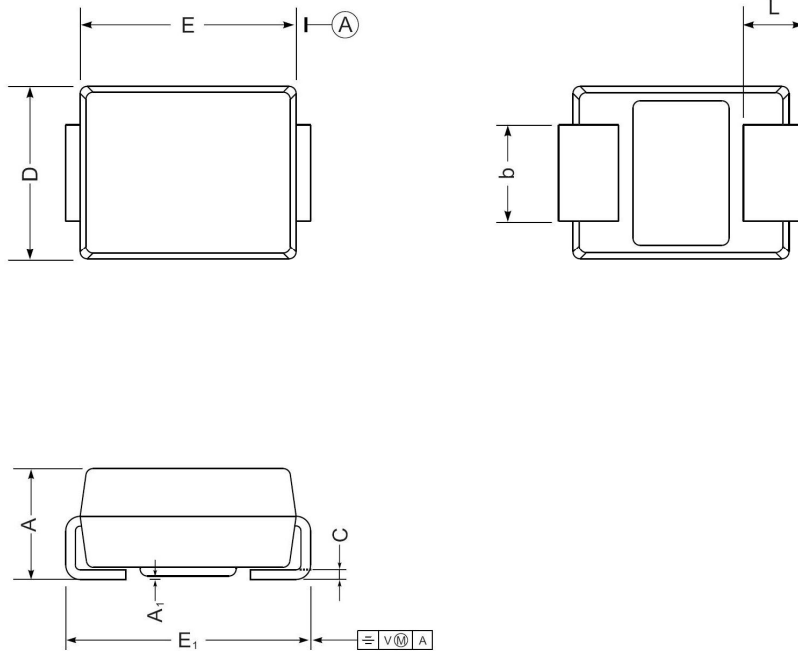

SMB mechanical data

UNIT		A	E	D	E <sub>1</sub>	A <sub>1</sub>	L	C	b
mm	max	2.44	4.70	3.94	5.59	0.20	1.5	0.305	2.2
	min	2.13	4.06	3.3	5.08	0.05	0.8	0.152	1.9
mil	max	96	185	155	220	7.9	59	12	87
	min	84	160	130	200	2.0	32	6	75

# Marking

Type number	Marking code
SS22B	SS22
SS24B	SS24
SS26B	SS26
SS28B	SS28
SS210B	SS210
SS212B	SS212
SS215B	SS215
SS220B	SS220

印章说明 / Marking Instructions

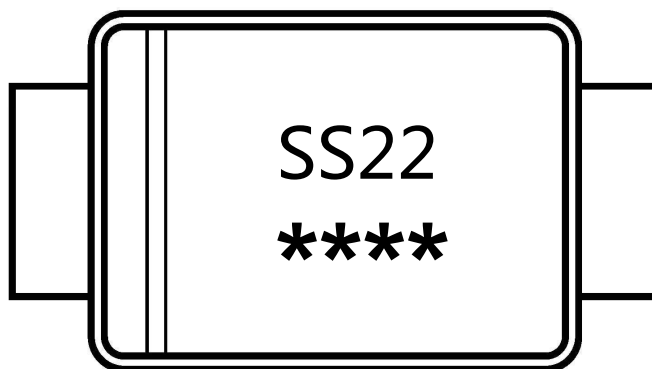

说明：

SS22： 为型号代码

\*\*\*\*： 为生产批号追溯码，第1个\*为年月代码，后面3个\*为当月小批号代码

Note:

SS22： Product Type Code

\*\*\*\*： Lot No. Code ,The 1st \* means:YM Code ,The last 3 \* means:little Lot No Code

**回流焊温度曲线图(无铅) / Temperature Profile for IR Reflow Soldering(Pb-Free)**

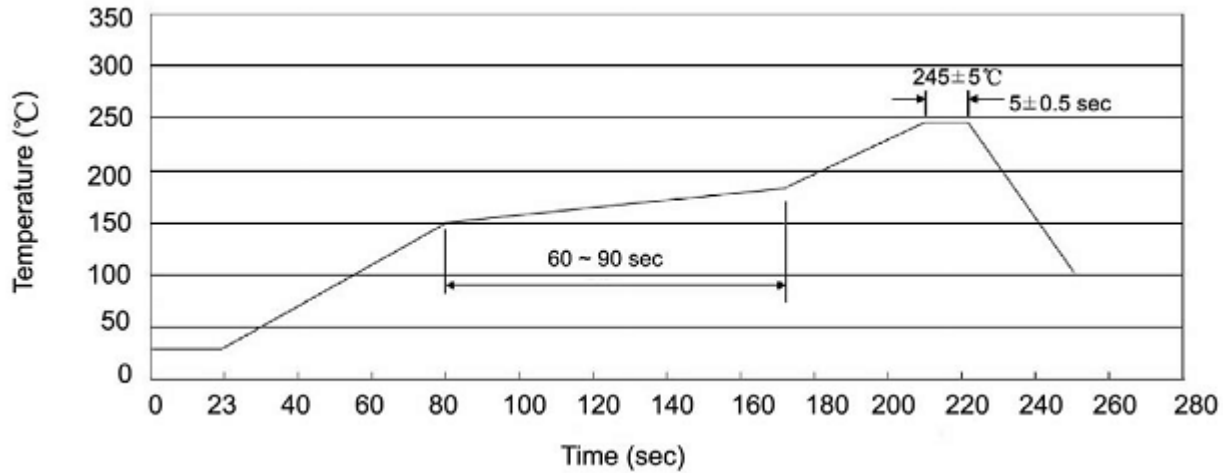

说明：

- 1、预热温度 25 ~ 150°C，时间 60 ~ 90sec;
- 2、峰值温度 245±5°C，时间持续为 5±0.5sec;
- 3、焊接制程冷却速度为 2 ~ 10°C/sec.

Note:

- 1.Preheating:25~150°C, Time:60~90sec.
- 2.Peak Temp.:245±5°C, Duration:5±0.5sec.
3. Cooling Speed: 2~10°C/sec.

**耐焊接热试验条件 / Resistance to Soldering Heat Test Conditions**

温度：260±5°C

时间：10±1 sec.

Temp.:260±5°C

Time:10±1 sec

**包装规格 / Packaging SPEC.**

卷盘包装 / REEL

Package Type 封装形式	Units 包装数量					Dimension 包装尺寸 (unit: mm <sup>3</sup> )		
	Units/Reel 只/卷盘	Reels/Inner Box 卷盘/盒	Units/Inner Box 只/盒	Inner Boxes/Outer Box 盒/箱	Units/Outer Box 只/箱	Reel	Inner Box 盒	Outer Box 箱
SMB	3000	5	15000	5	75000	7" ×11	185X180X105	390X385X205

**使用说明 / Notices**

## X-ON Electronics

Largest Supplier of Electrical and Electronic Components

*Click to view similar products for [Schottky Diodes & Rectifiers](#) category:*

*Click to view products by [Blue Rocket](#) manufacturer:*

Other Similar products are found below :

[MA4E2039](#) [MA4E2508M-1112](#) [MBR1545CT](#) [MMBD301M3T5G](#) [RB160M-50TR](#) [D83C](#) [BAS16E6433HTMA1](#) [BAT 54-02LRH E6327](#)  
[NRVBAF360T3G](#) [NSR05F40QNXT5G](#) [NTE555](#) [JANS1N6640](#) [SK310-T](#) [SK34B-TP](#) [SS3003CH-TL-E](#) [GA01SHT18](#)  
[CRS10I30A\(TE85L,QM](#) [MA4E2501L-1290](#) [MBRA140TRPBF](#) [MBRB30H30CT-1G](#) [BAT 15-04R E6152](#) [JANTX1N5712-1](#) [DMJ3940-000](#)  
[SB007-03C-TB-E](#) [SK33B-TP](#) [NRVBB20100CTT4G](#) [NRVBM120LT1G](#) [NTSB30U100CT-1G](#) [VS-6CWQ10FNHM3](#) [CRG04\(T5L,TEMQ\)](#)  
[ACDBA1100LR-HF](#) [ACDBA1200-HF](#) [ACDBA240-HF](#) [ACDBA3100-HF](#) [CDBQC0530L-HF](#) [CDBQC0240LR-HF](#) [ACDBA260LR-HF](#)  
[ACDBA1100-HF](#) [MA4E2502L-1246](#) [10BQ015-M3/5BT](#) [NRVBM120ET1G](#) [CRS08TE85LQM](#) [PMAD1108-LF](#) [B120Q-13-F](#) [1N5819T-G](#)  
[B0530WSQ-7-F](#) [PDS1040Q-13](#) [B160BQ-13-F](#) [SDM05U20CSP-7](#) [B140S1F-7](#)