

描述 / Descriptions

SOT-23 塑封封装精密可调基准电源。

Precision adjustable shunt regulator in a SOT-23 Plastic Package.

特征 / Features

精确参照电压 2.495V;允许电压误差为 0.5%,1%或 2%;阴极电流能力为 1.0mA ~ 100mA;快速导通;可调节输出电压为 $V_O=V_{ref} \sim 36V$;阴极工作电流低(典型值:50 μ A);动态输出阻抗低(典型值:0.15 Ω)。

Precise reference voltage to 2.495V;guaranteed 0.5%,1% or 2% reference voltage Tolerance; sink current capability,1.0mA~100mA;quick turn-on; adjustable Output voltage, $V_O=V_{ref} \sim 36V$;low operational cathode current,50 μ A typical; 0.15 Ω typical output impedance.

用途 / Applications

用于线性调整器,可调节电源和开关电源。

Linear regulators, adjustable power supply, switching power supply.

内部等效电路 / Equivalent Circuit

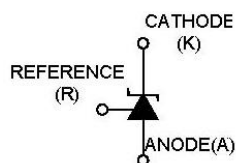

引脚排列 / Pinning



PIN 1 : R

PIN 2 : K

PIN 3 : A

放大及印章代码 / h_{FE} Classifications & Marking

Marking	H431
---------	------

极限参数 / Absolute Maximum Ratings(Ta=25°C)

参数 Parameter	符号 Symbol	数值 Rating	单位 Unit
Cathode to Anode Voltage	V_{KA}	37	V
Cathode Current Range, Continuous	I_K	-100~+100	mA
Reference Input Current Range, Continuous	I_{REF}	0.05~+10	mA
Power Dissipation	P_D	370	mW
Operating Ambient Temperature	T_{amb}	-40~125	°C
Junction Temperature	T_j	150	°C
Storage Temperature Range	T_{stg}	-65~150	°C

电性能参数 / Electrical Characteristics(Ta=25°C)

参数 Parameter	符号 Symbol	测试条件 Test Conditions	最小值 Min	典型值 Typ	最大值 Max	单位 Unit
Reference Input Voltage	V_{REF}	$V_{KA}=V_{REF}$ $I_K=10mA(A=0.5\%)$	2.483	2.495	2.507	V
		$V_{KA}=V_{REF}$ $I_K=10mA(B=1\%)$	2.470	2.495	2.520	V
		$V_{KA}=V_{REF}$ $I_K=10mA(2\%)$	2.445	2.495	2.545	V
Deviation of Reference Input Voltage Over-Temperature	$\Delta V_{REF} / \Delta T$	$V_{KA}=V_{REF}$ $I_K=10mA$ $T_A=-40 \sim 125^\circ C$		4.5	25	mV
Ratio of Change in Reference Input Voltage to the Change in Cathode Voltage	$\Delta V_{REF} / \Delta V_{KA}$	$I_K=10mA,$ $\Delta V_{KA} =10V \text{ to } V_{REF}$		-1	-2.7	mV/V
		$I_K=10mA,$ $\Delta V_{KA} =36V \text{ to } 10V$		-0.5	-2.0	mV/V
Reference Input Current	I_{REF}	$I_K=10mA$ $R_1=10K\Omega$ $R_2=open$		0.8	1.0	μA
Deviation of Reference Input Current Over Full Temperature Range	$\Delta I_{REF} / \Delta T$	$I_K=10mA$ $R_1=10K\Omega$ $R_2=open$ $T_A=-40 \sim 125^\circ C$		0.4	1.2	μA
Minimum Cathode Current for Regulation	$I_{K(min)}$	$V_{KA}=V_{REF}$		0.05	0.08	mA
Off-state cathode current	$I_{K(off)}$	$V_{KA}=36V$ $V_{REF}=0V$		0.05	1.0	μA
Dynamic Impedance	$ Z_{KA} $	$V_{KA}=V_{REF}$ $f \leq 1.0KHz$ $I_K=1mA \text{ to } 100mA$		0.15	0.5	Ω

电参数曲线图 / Electrical Characteristic Curve

Fig 1 Cathode Current Vs Cathode Voltage

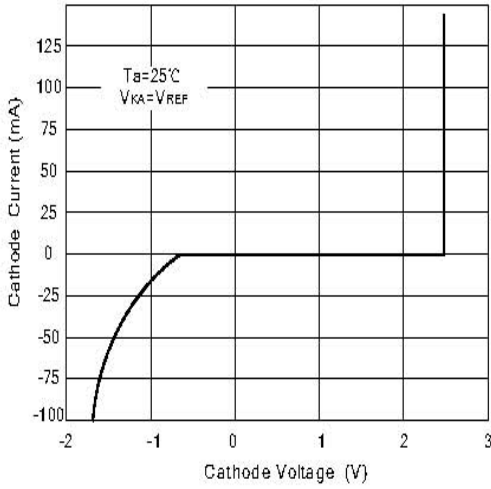

Fig 2 Cathode Current Vs Cathode Voltage

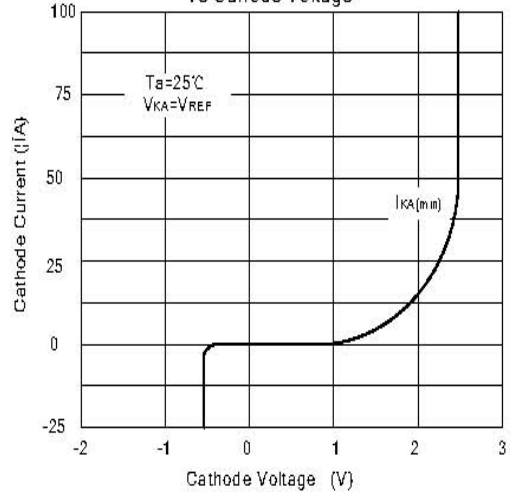

Fig 3 Change in Reference Input Voltage Vs Cathode voltage

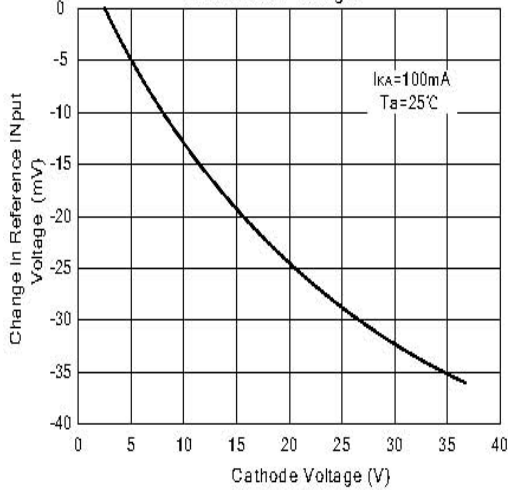

Fig 4 Pulse Response

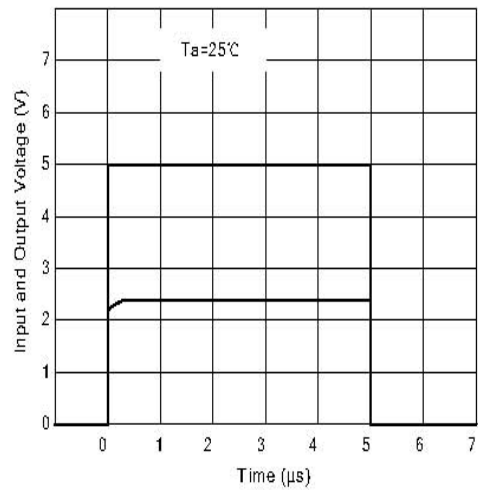

Fig 5 Dynamic Impedance Vs Frequency

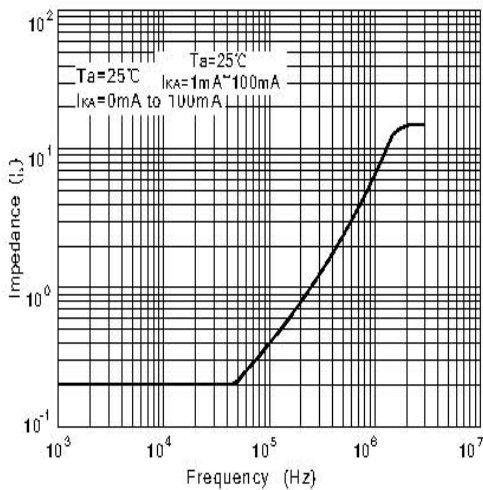
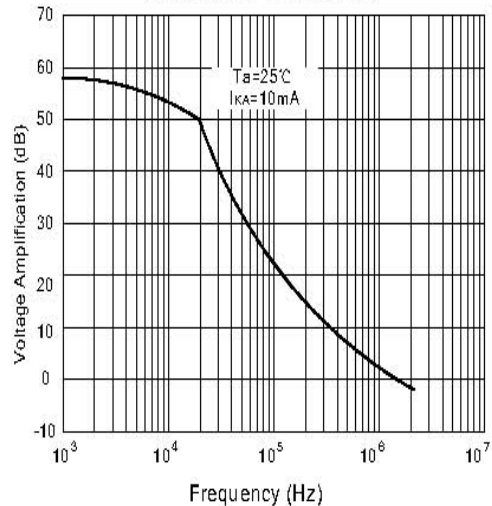
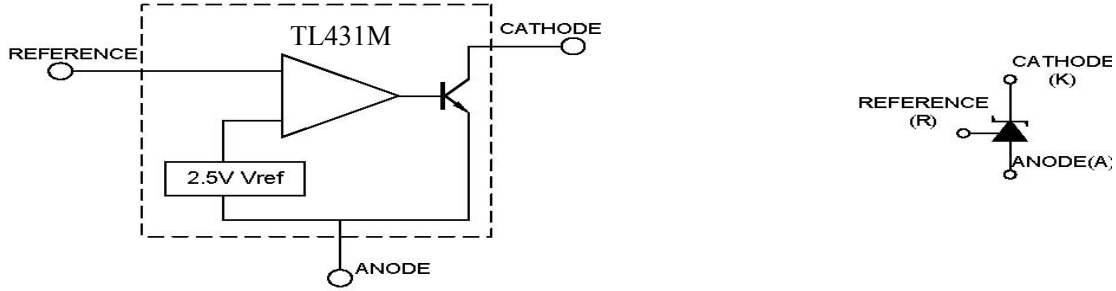

Fig 6 Small Signal Voltage Amplification Vs Frequency



测试电路图&典型应用图 Test circuits&Typical Application

BLOCK DIAGRAM:



TEST CIRCUITS:

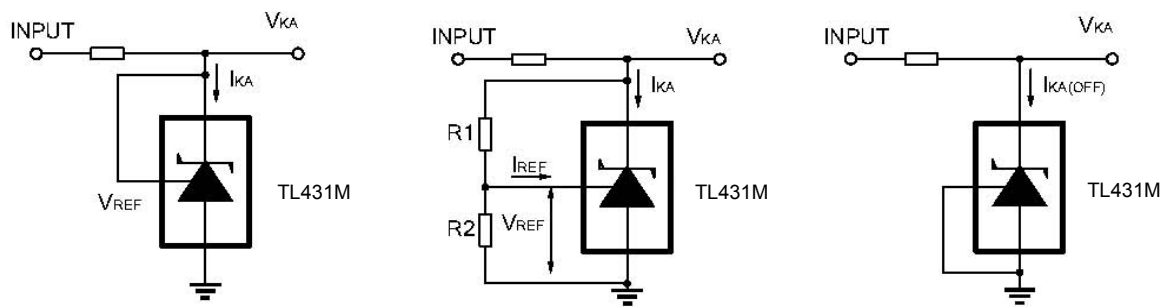

Test Circuit For $V_{KA}=V_{REF}$

$$V_{KA} = V_{REF} \cdot (1 + R1/R2) + I_{REF} \cdot R1$$

Test Circuit for $V_{KA} \geq V_{REF}$

Test Circuit For $I_{KA(OFF)}$

TYPICAL APPLICATION:

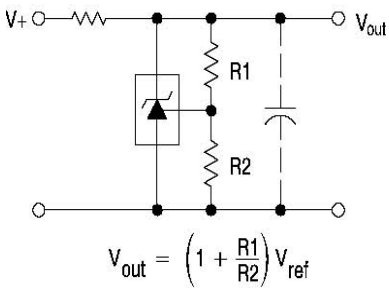

Shutdown Regulator

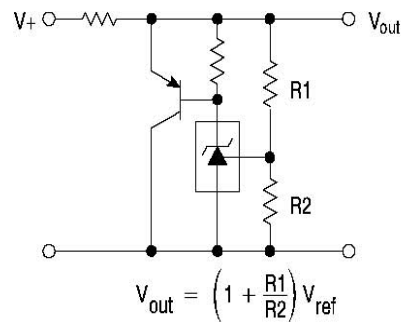

Higher-current Shunt

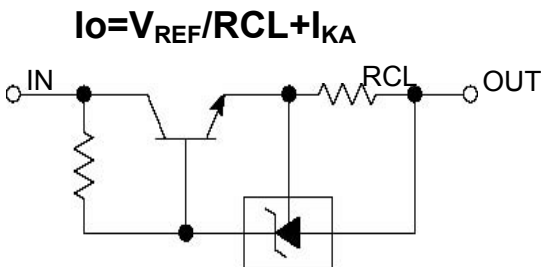

Constant Current Source TL431M

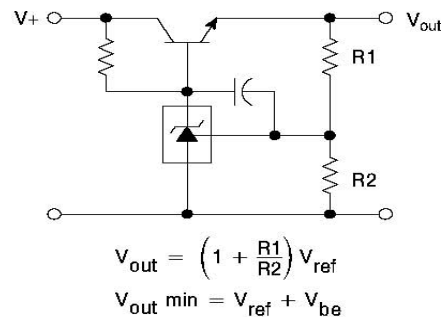

Series Pass Regulator

外形尺寸图 / Package Dimensions

SOT-23

单位: mm

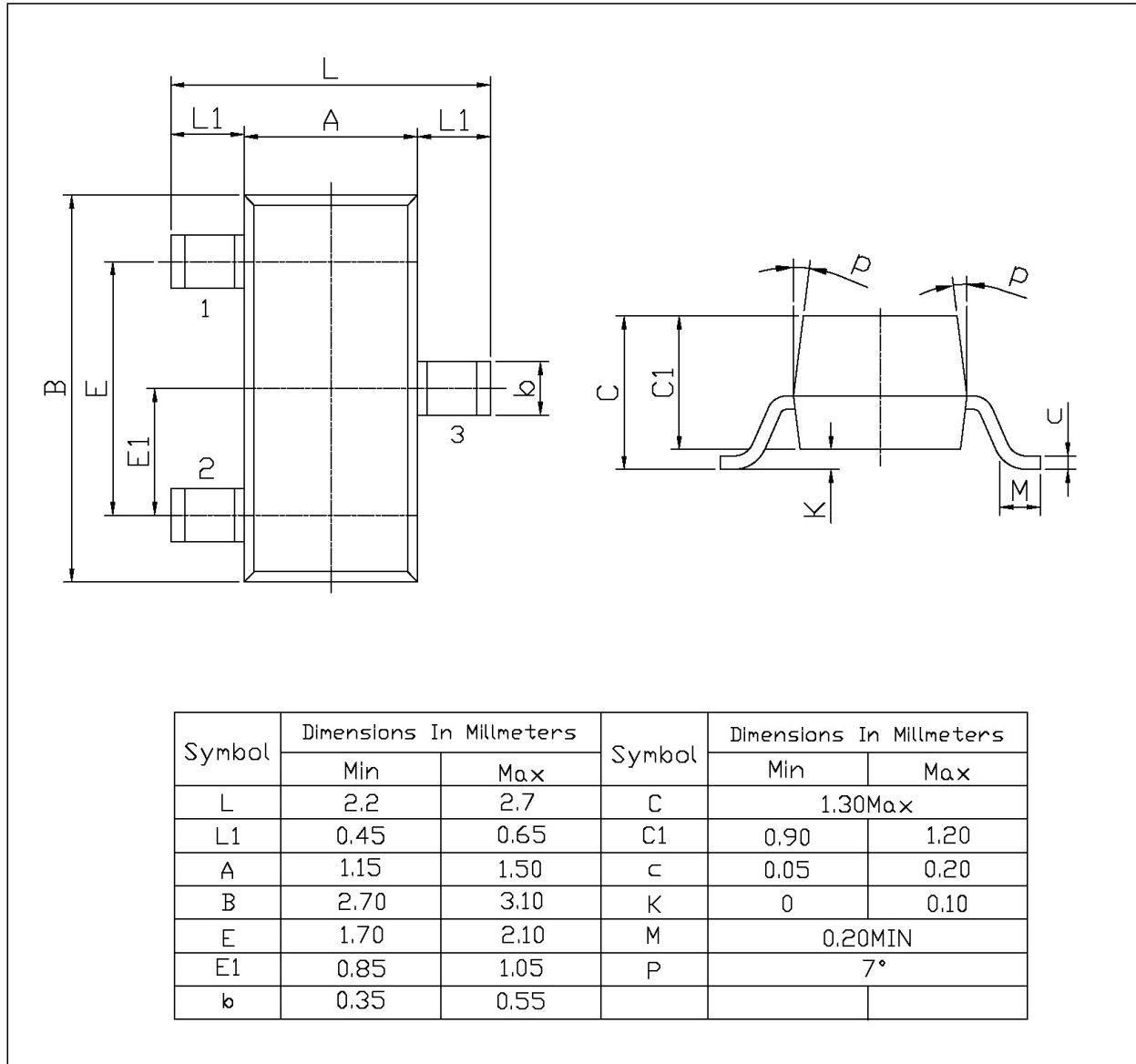

印章说明 / Marking Instructions

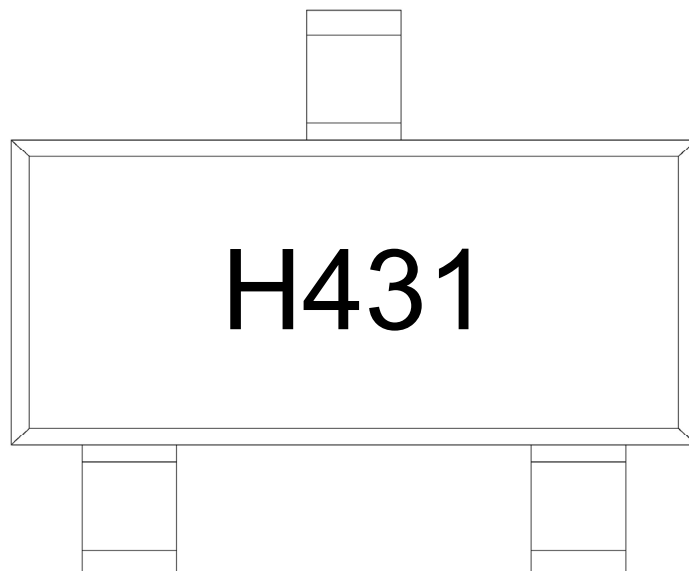

说明：

H： 为公司代码

431： 为型号代码

Note:

H: Company Code.

431: Product Type.

回流焊温度曲线图(无铅) / Temperature Profile for IR Reflow Soldering(Pb-Free)



说明：

- 1、预热温度 25 ~ 150°C，时间 60 ~ 90sec;
- 2、峰值温度 245±5°C，时间持续为 5±0.5sec;
- 3、焊接制程冷却速度为 2 ~ 10°C/sec.

Note:

- 1.Preheating:25~150°C, Time:60~90sec.
- 2.Peak Temp.:245±5°C, Duration:5±0.5sec.
3. Cooling Speed: 2~10°C/sec.

耐焊接热试验条件 / Resistance to Soldering Heat Test Conditions

温度：260±5°C

时间：10±1 sec.

Temp.:260±5°C

Time:10±1 sec

包装规格 / Packaging SPEC.

卷盘包装 / REEL

Package Type 封装形式	Units 包装数量					Dimension 包装尺寸 (unit: mm ³)		
	Units/Reel 只/卷盘	Reels/Inner Box 卷盘/盒	Units/Inner Box 只/盒	Inner Boxes/Outer Box 盒/箱	Units/Outer Box 只/箱	Reel	Inner Box 盒	Outer Box 箱
SOT-23	3,000	10	30,000	6	180,000	7" ×8	180×120×180	390×385×205

使用说明 / Notices

X-ON Electronics

Largest Supplier of Electrical and Electronic Components

Click to view similar products for [Voltage References](#) category:

Click to view products by [Blue Rocket](#) manufacturer:

Other Similar products are found below :

[AS431ARTR-E1](#) [AZ431BR-ATRE1](#) [5962-8686103XC](#) [NCV431BVDMR2G](#) [REF01J/883](#) [SC431ILPRAG](#) [AP432AQG-7](#) [LM4040B25QFTA](#)
[REF5020IDGKR](#) [TL431BL3T](#) [TL431ACZ](#) [KA431SLMF2TF](#) [KA431SMF2TF](#) [KA431SMFTF](#) [LM4040QCEM3-3.0/NOPB](#)
[LM4041C12ILPR](#) [LM4120AIM5-2.5/NOP](#) [LM431SCCMFX](#) [ZXRE250BSA-7](#) [ZXRE125DN8TA](#) [TS3330AQPR](#) [ZXRE250ASA-7](#)
[ZTL431ASE5TA](#) [ADR3512WCRMZ-R7](#) [REF3012AIDBZR](#) [LM385BM-2.5/NOPB](#) [LM385D-2.5R2G](#) [LM4040AIM3-10.0](#) [LM4040BIM3-4.1](#) [LM4040CIM3-10.0](#) [LM4040CIM3X-2.0/NOPB](#) [LM4041QDIM3-ADJ/NO](#) [LM4051BIM3-ADJ/NOPB](#) [LM4051CIM3X-1.2/NOPB](#)
[LM4128CMF-1.8/NOPB](#) [LM4132DMF-1.8/NOPB](#) [LM4132EMF-1.8/NOPB](#) [LM4132EMF-2.0/NOPB](#) [LM431CIM](#) [LM385BD-2.5R2G](#)
[LM385M-2.5/NOPB](#) [LM4030AMF-4.096/NOPB](#) [LM4040D30ILPR](#) [LM4051CIM3X-ADJ/NOPB](#) [AP432YG-13](#) [AP431IANTR-G1](#)
[AP431AWG-7](#) [AS431ANTR-G1](#) [AS431AZTR-G1](#) [AS431BZTR-E1](#)