

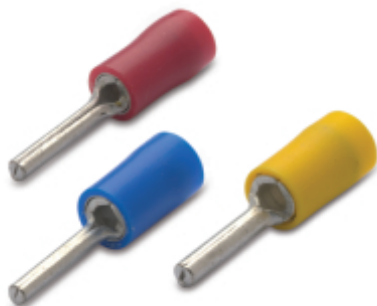

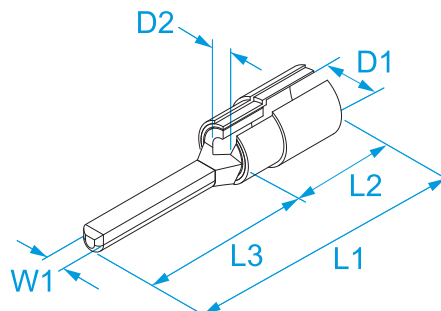



**Product family:** Terminals - Insulated terminal lugs from sheet  
**Code:** 90150, 90150KL, 90151, 90250, 90250KL, 90251, 90350, 90350KL  
**Description:** TERMINAL LUGS FOR COPPER CONDUCTORS · PVC INSULATED AND ANTI-VIBRATING FROM SHEET · ROUND PIN

**Image:**

**Technical Drawing:**

**Specifications:**

**TERMINAL MATERIAL:** tinned copper  
**END-SLEEVE MATERIAL:** copper  
**INSULATION MATERIAL:** polyvinylchloride (PVC)  
**INSULATION SELF-EXTINGUISHING GRADE:** UL 94 V0  
**RATED VOLTAGE:** 300 V max  
**OPERATING TEMPERATURE:** 75 °C max  
**ASSEMBLING:** double crimping

Code	Color	Section (mm <sup>2</sup> )	Section (AWG/MCM)	W1 (mm)	L1 (mm)	L2 (mm)	L3 (mm)	D1 (mm)	D2 (mm)		
90150		Red	0.25 ÷ 1.5	(22 - 16)	1,9	22	10	12	4,4	1,7	100/1000
90151		Red	0.25 ÷ 1.5	(22 - 16)	1,9	19	10	9	4,4	1,7	
90250		Blue	1.5 ÷ 2.5	(16 - 14)	1,9	22	10	9	5	2,4	100/1000
90251		Blue	1.5 ÷ 2.5	(16 - 14)	1,9	19	10	9	5	2,4	
90350		Yellow	4 ÷ 6	(12 - 10)	2,7	28	14	14	6,7	3,6	50/500

**V0**

## X-ON Electronics

Largest Supplier of Electrical and Electronic Components

*Click to view similar products for [Terminals](#) category:*

*Click to view products by [BM Group](#) manufacturer:*

Other Similar products are found below :

[00-054007-01074-6](#) [00-054007-70206-1](#) [00-054007-70210-8](#) [00-054007-70217-7](#) [00-054007-70226-9](#) [00-054007-70228-3](#) [00-054007-70248-1](#) [00-054007-70256-6](#) [00-054007-70301-3](#) [00-054007-70316-7](#) [00-054007-49560-4](#) [00-054007-70209-2](#) [00-054007-70225-2](#) [00-054007-70227-6](#) [00-054007-70231-3](#) [00-054007-70241-2](#) [00-054007-70242-9](#) [00-054007-70244-3](#) [00-054007-70246-7](#) [00-054007-70263-4](#) [00-054007-70288-7](#) [00-054007-70290-0](#) [00-054007-70300-6](#) [00-054007-70304-4](#) [01-2065-1-0216](#) [01-2900-1-04412](#) [00581P0075](#) [600TS-10](#) [60205-1](#) [604200-1](#) [605601-1](#) [60598-1-CUT-TAPE](#) [60617-1-C](#) [61314-6-C](#) [61810-3](#) [61-S](#) [626-0194](#) [62-NBM-A](#) [62-SP](#) [63-S](#) [640179-1](#) [M55155/059I03](#) [M55155/079C01](#) [M55155/099H02](#) [M55155/109H01](#) [M55155/109H02](#) [M55155/12XH05](#) [M55155/16XH02](#) [M55155/29-5S](#) [M55155/29XJ08](#)