

Product family: Terminals - End-sleeves terminals
Item code: 90501, 90601, 90502, 90702, 90602, 90503, 90603, 90504, 90604, 90506, 90706
Description: END-SLEEVES FOR COPPER CONDUCTORS · INSULATED · SINGLE CABLE · IN A STRAP

Image

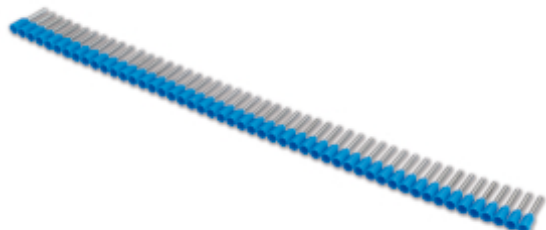

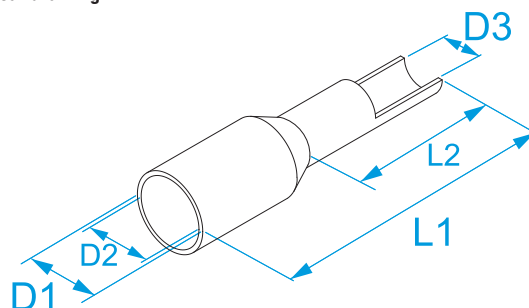









Technical drawing



Specifications

TERMINAL MATERIAL: tinned copper
INSULATION MATERIAL: polypropylene (PP) without flame retardant
OPERATING TEMPERATURE: 105 °C max
ACCORDING TO STD.: DIN 46228-4 (tubular ferrules with plastic sleeve), UL486F (bare and covered ferrules)

Code	Color	Standard color 1	Standard color 2	Color DIN 46228/4	Section (mm ²)	Section (AWG/MCM)	L1 (mm)	L2 (mm)	D1 (mm)	D2 (mm)	D3 (mm)		
90501		Orange	√	-	-	0,5	(20)	14	8	3,1	2,6	1	500/2500
90601*		White	-	√	√	0,5	(20)	14	8	3,1	2,6	1	
90502		White	√	-	-	0,75	(18)	14	8	3,3	2,8	1,2	500/2500
90702		Light blue	-	√	-	0,75	(18)	14	8	3,3	2,8	1,2	
90602*		Grey	-	-	√	0,75	(18)	14	8	3,3	2,8	1,2	500/2500
90503		Yellow	√	-	-	1	(18)	14	8	3,5	3	1,4	
90603*		Red	-	√	√	1	(18)	14	8	3,5	3	1,4	500/2500
90504		Red	√	-	-	1,5	(16)	14	8	4	3,5	1,7	
90604*		Black	-	√	√	1,5	(16)	14	8	4	3,5	1,7	500/2500
90506*		Blue	√	-	√	2,5	(14)	14	8	4,7	4,2	2,2	
90706		Grey	-	√	-	2,5	(14)	14	8	4,7	4,2	2,2	500/2500



* file n° E 506333



X-ON Electronics

Largest Supplier of Electrical and Electronic Components

Click to view similar products for [Terminals](#) category:

Click to view products by [BM Group](#) manufacturer:

Other Similar products are found below :

[00-054007-01074-6](#) [00-054007-70206-1](#) [00-054007-70210-8](#) [00-054007-70217-7](#) [00-054007-70226-9](#) [00-054007-70228-3](#) [00-054007-70248-1](#) [00-054007-70256-6](#) [00-054007-70301-3](#) [00-054007-70316-7](#) [00-054007-49560-4](#) [00-054007-70209-2](#) [00-054007-70225-2](#) [00-054007-70227-6](#) [00-054007-70231-3](#) [00-054007-70241-2](#) [00-054007-70242-9](#) [00-054007-70244-3](#) [00-054007-70246-7](#) [00-054007-70263-4](#) [00-054007-70288-7](#) [00-054007-70290-0](#) [00-054007-70300-6](#) [00-054007-70304-4](#) [01-2065-1-0216](#) [01-2900-1-04412](#) [00581P0075](#) [600TS-10](#) [60205-1](#) [604200-1](#) [605601-1](#) [60598-1-CUT-TAPE](#) [60617-1-C](#) [61314-6-C](#) [61810-3](#) [61-S](#) [626-0194](#) [62-NBM-A](#) [62-SP](#) [63-S](#) [640179-1](#) [M55155/059I03](#) [M55155/079C01](#) [M55155/099H02](#) [M55155/109H01](#) [M55155/109H02](#) [M55155/12XH05](#) [M55155/16XH02](#) [M55155/29-5S](#) [M55155/29XJ08](#)