



## High Power UV-C LED

Product Specifications  
6060 SMD Packaged LED

V1.3 June 2019

## 6060 SMD Packaged LED Identification Convention

SMD6060 type package



S6060-IF250-*Wavelength*--*Power*--*Voltage*

Emission Peak  
+/- 5 nm

mW @ 250mA  
+/- 10%

Voltage @ 250mA  
+/- 0.5 V

### Example:

S6060-IF250-W270-P110-V6.0

### Interpretation:

Surface Mount type 6.0 x 6.0 mm packaged LED

Driving current = 250 mA

Peak wavelength = 270 +/- 5nm

Power output @ 250mA = 110 mW (+/-10%)

Forward voltage @ 250mA = 6.0V (+/- 0.5V)

*Product specifications subject to change without notice*

6060 SMD Packaged LED Diagram

MH design 6060 SMD

All Units = mm

① Cathode (-)

② Anode (+)

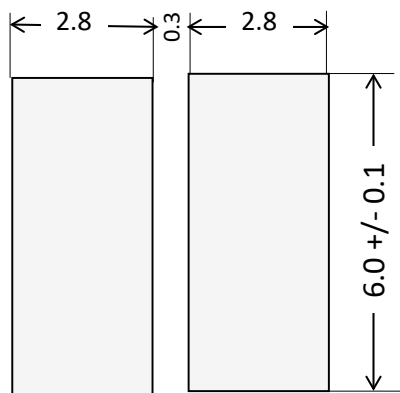
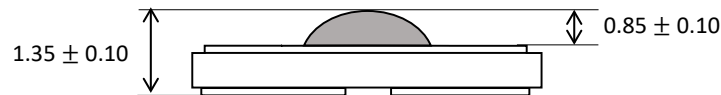
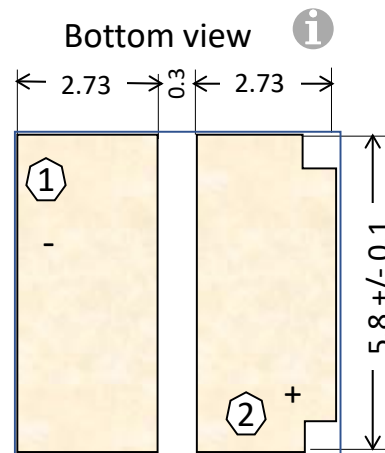
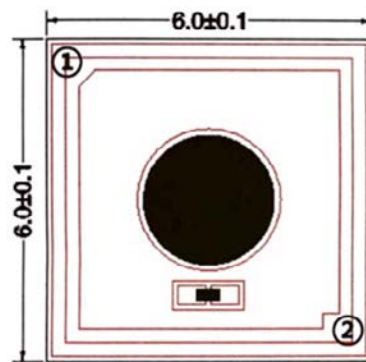

Electrical scheme of SMD

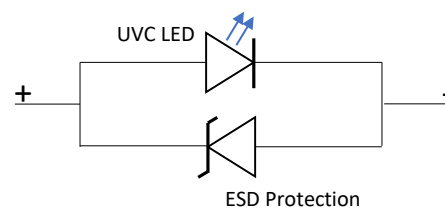

Drawings not exactly to scale  
Specifications subject to change without notice

6060 SMD Packaged LED Diagram

K/L designs 6060 SMD

All Units = mm

① Anode (+)

② Cathode (-)

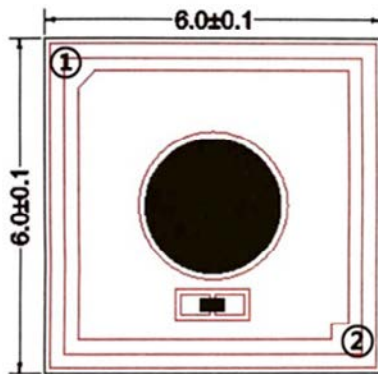

Bottom view

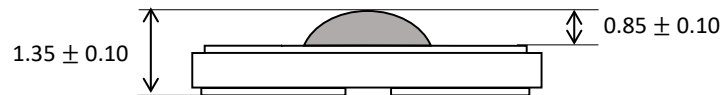
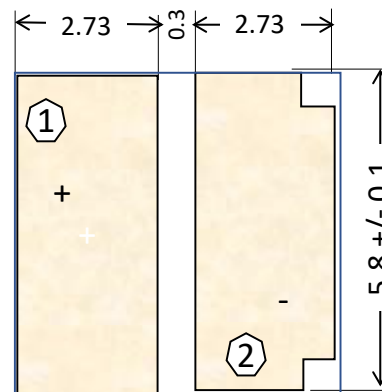

Recommended Solder Pattern on PCB

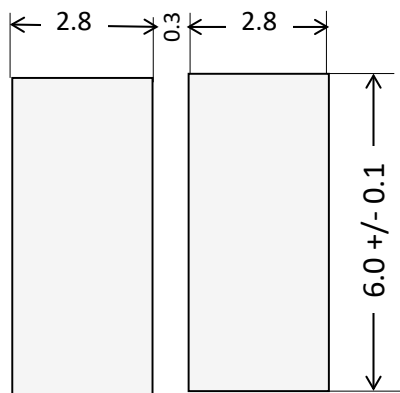

Electrical scheme of SMD

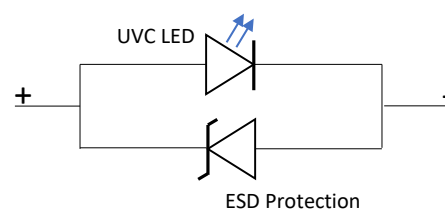

Drawings not exactly to scale  
Specifications subject to change without notice

Hex 6060 SMD Packaged LED Diagram

# SMD LED on Hex MCPCB

All sizes in mm

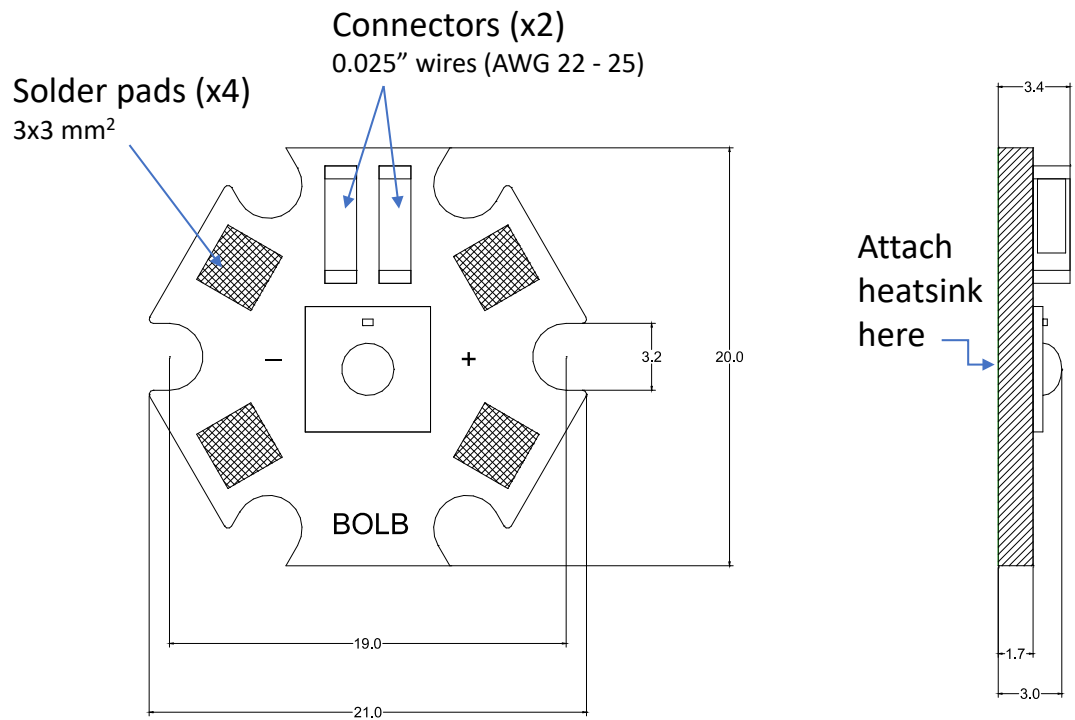

## Product benefits

- Same popular MCPCB format for visible LEDs
- Eliminates reflow soldering
- Plug-n-play with 0.025" wires (AWG 24 or 25)
- Larger contact area for heat extraction
- Nomenclature example:

**Hex-S6060-W270-P150-V6.0**

UVC LED: Electro-optical parameters

TABLE 1. Performance @ 250 mA forward current (25°C ambient, packaged)

Parameter	Symbol	Unit	Min.	Typ.	Max
Peak Wavelength	$\lambda_p$	nm	265	270	277
Radiant Flux	$\phi_e$	mW	80	100	110
			110	120	130
Forward Voltage	VF	V	6.0	6.5	7.0
Spectrum Half Width	$\Delta\lambda$	nm		10	
View Angle	$2\theta_{1/2}$	°		150	
Thermal Resistance	RJ-b	°C/W		<10 (TBD)	

FIG 1. Forward Current vs. Forward Voltage  
Please also check typical value and BIN structure on page 8

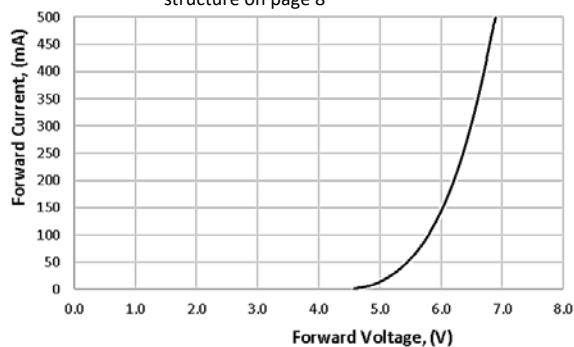
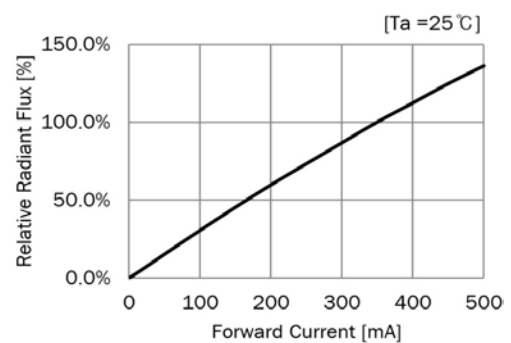

FIG 2. Relative Radiant Flux vs. Forward Current



Specifications may subject to change without notice

UVC LED: Electro-optical parameters (continued)

FIG 3. Peak Wavelength vs. Forward Current

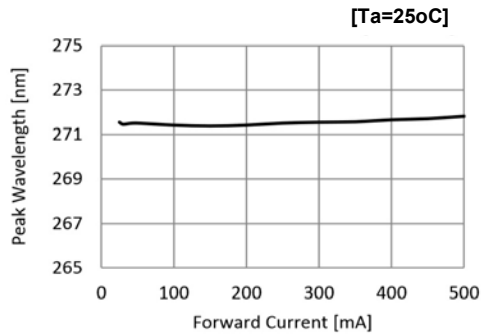

FIG 4. Spectrum

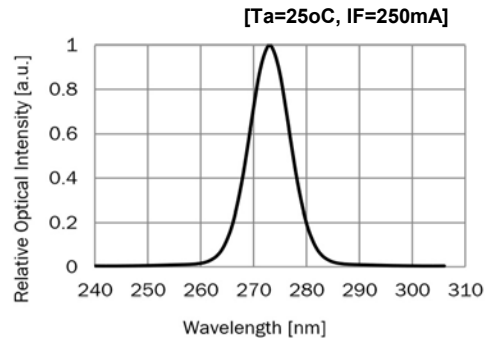

Fig 5. Forward Voltage vs Ambient Temperature

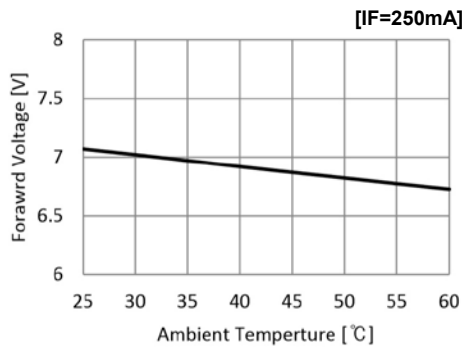

Fig 6. Relative Radiant Flux vs Ambient Temperature

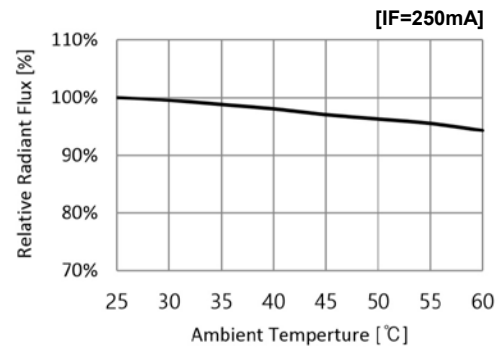
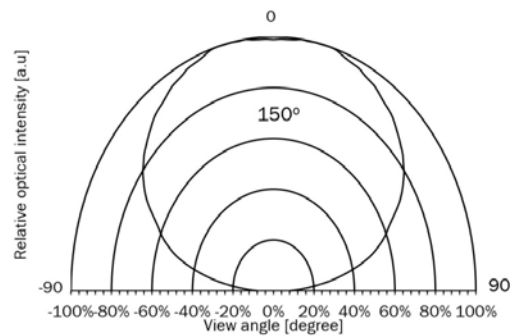

Fig 7. Far-field Emission Pattern



UVC LED: Electro-optical parameters (continued)

TABLE 2. Device lifetime (forward current =250mA, Tj < 55°C)

Parameter	Symbol	Unit	Min.	Typ.	Max
70% Power Lifetime	L70	hours	850*	1000*	2000*
50% Power Lifetime	L50	hours	1200*	3000*	5000*

\*Values subject to change: please inquire about latest update

4-hour 65°C water immersion test passed without failure





UVC LED: Electro-optical parameters (continued)

TABLE 3. Bin Structures

[ Ta =25°C, I<sub>F</sub> = 250mA]

Designate	Information	Code	Min	Typ.	Max.
W	Peak Wavelength	270	265	270	275
		275	275	277	280
P	Radiant Flux (Φ <sub>e</sub> )	80	75	80	85
		90	85	90	95
		100	95	100	105
		110	105	110	115
		120*	115	120	125
		130*	125	130	135
V	Forward Voltage (V)	5.5	5.0	5.5	6.0
		6.5	6.0	6.5	7.0
		7.5	7.0	7.5	8.0

\*Special Request

Note: Bin Code method

Bin Code (IF-W-P-V): Driving current= IF; Peak Wavelength = W ; Radiant Flux = P ; Forward Voltage = V

Soldering conditions of UVC LED

FIG 8. Solder reflow temperature profile

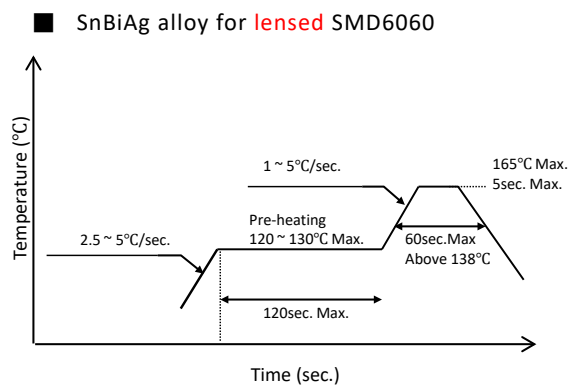

Reflow Soldering Instructions	
	SnBiAg alloy (Melting Temperature=138°C)
Pre-Heating	120 ~ 130°C
Pre-Heat Time	120sec. Max.
Peak Temperature	165°C Max.
Soldering Time	5sec. Max.

- Recommended solder composition: SnBiAg alloy or T3 soldering paste)
  - Recommended stencil thickness is 60~80um
  - Recommended stencil solder paste area is 60~80%
  - Forming gas (5%-7%H<sub>2</sub> in N<sub>2</sub>) ambient recommended for best results
  - After reflow soldering, Rapid cooling should be avoided
  - When soldering, do not use a none calibrated hot plate. A convection type reflow oven is preferred. (Fig 9.)
- Must not use heat gun (blower) for soldering**

FIG 9. Do not use a hot plate to mount led-package onto PCB. A reflow oven is recommended.

## Handling Precautions

### ESD Protection

Workplace setup should follow the recommendations given in JEDEC standard document JESD625B "Requirements for Handling Electrostatic-Discharge-Sensitive (ESDS) Devices" or IEC 61340-5-1,2 and 3. The operators should be properly trained to handle UVC flipchips according to the guidelines listed below:

- Always wear conductive wrist straps that is continuously monitored when working or handling assembled boards containing unprotected chips.
- Use an ion blower to neutralize the static discharge that may build up on the surface of the UVC flipchips during storage and handling.
- Always keep unused UVC flipchips in the protective ESD storage bag. Depending on the final application, it may be necessary to include additional ESD protection, such as a TVS protection diode on the substrate on which UVC flip chip is reflowed. Bolb Inc. includes a TVS chip inside each LED package.
- Use tweezers to pick up UVC LEDs, teflon coated tweezers would be recommended to avoid scratching UVC LEDs.
- Recommend holding the sidewalls of the LEDs (See Fig 10.)

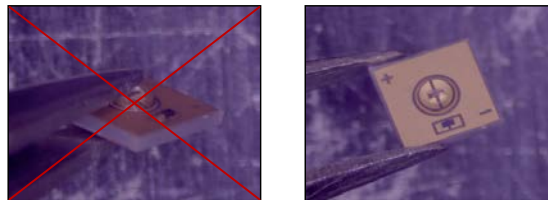
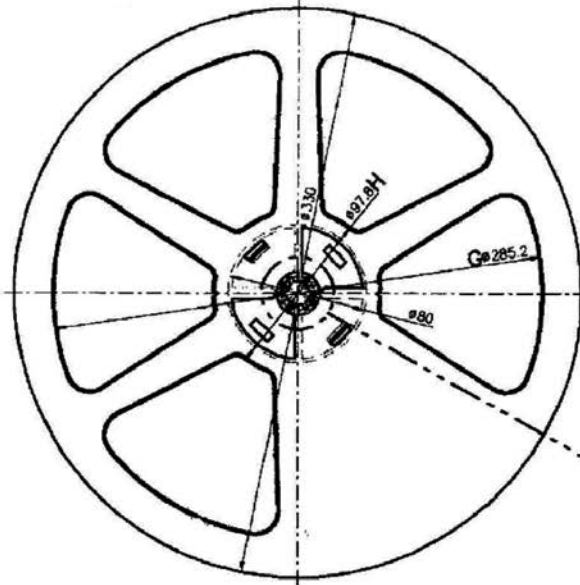
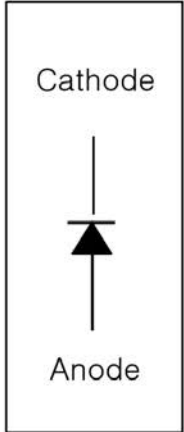
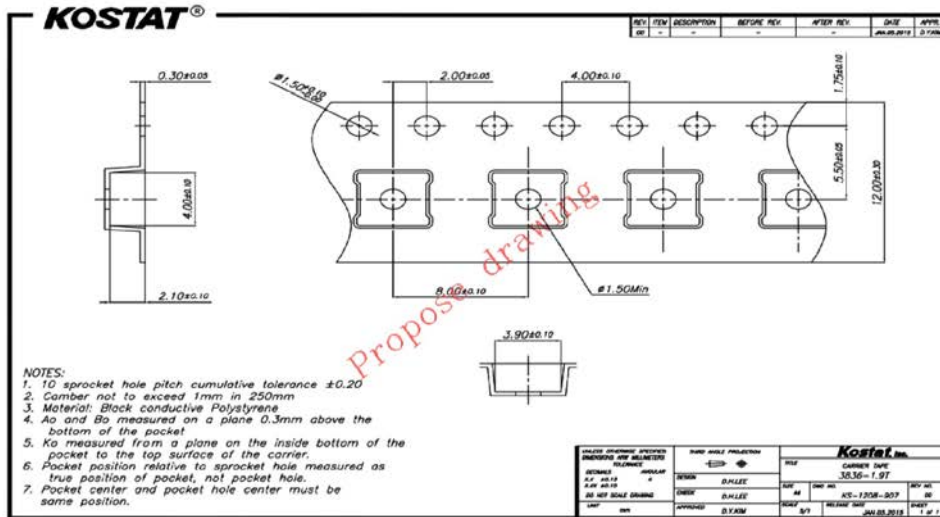

FIG 10. incorrect handling (left) and correct handling (right) of UVC LED Package

## Packing

### Carrier Tape & Reel Dimensions (unit = mm)



Quantity < 3,000 units/reel  
Cover tape adhesion < 0.7 Newtons  
Leader tape < 200 empty pockets  
Trailer < 60 empty pockets

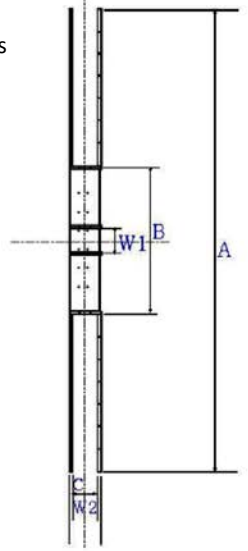

## General Precautions and UVC Safety



UVC LEDs emit deep ultraviolet radiation, with extremely high intensity near its surface. This allows rapid disinfection but safety precautions must be observed during assembly and testing.

By purchasing the UVC chips (bare dice) or packaged LEDs from the manufacturer, the customer hereby agrees to absolve the manufacturer's responsibility of any bodily harm as a result of failure to observe the precautions, warnings and guidelines contained within this Specifications document.

All assembly workers, operators and bystanders must wear eye and skin protection when the UVC LEDs are energized. Bare-eye observation (including through microscopes) and bare-hand handling of a UVC LED in operation is **PROHIBITED**.

UVC light can be easily absorbed, so any oil or other absorbent liquid or solid substance must **NOT** be allowed to touch the sapphire side of the UVC chip, or the dome lens on a packaged LED.

Do not apply pressure to the dome lens on packaged LED.

## X-ON Electronics

Largest Supplier of Electrical and Electronic Components

*Click to view similar products for [Standard LEDs - Through Hole category](#):*

*Click to view products by [BOLB manufacturer](#):*

Other Similar products are found below :

[LTL-10254W](#) [LTL-1214A](#) [LTL-1BEDJ](#) [LTL-2231AT](#) [LTL-3251A](#) [LTL-4262N](#) [LTL-5234](#) [LTL87HTBK](#) [LTD-87HD4B](#) [7383/V7C3-BSTA-L/PR3/MS](#) [G22041431007J2C000](#) [HLMP-AG64-X10ZZ](#) [HLMP-EG1A-Z10DV](#) [HLMP-EL3B-WXKDD](#) [HLMP-HB74-UVBDD](#) [HLMP-HG65-VY0DD](#) [HLMP-HM74-34CDD](#) [HLMP-HM75-34CDD](#) [1L0532V23G0TD001](#) [NSPW500CS](#) [C4SMA-BGF-CQ34Q3C2](#) [L53GC13](#) [264-7SURTS530-A3](#) [L-C150JRCT](#) [S4SMS-BJF-CQ42QGF2](#) [S4SMS-GJF-CW12QMF2](#) [LD CQDP-1U3U-W5-1-K](#) [LNX998CKBDA](#) [LO566UHR3-70G-A3](#) [SLA560WBD2PT3](#) [LP379PPG1C0G0300001](#) [SLR-322MCT32](#) [SLR-342DUT32](#) [SLR-342MC3F](#) [SLR343BC7TT32](#) [SLR343BCTT32](#) [SLX-LX3044GD](#) [SLX-LX3044ID](#) [SLX-LX3044YD](#) [SNW-LX504SRC/4](#) [1.90690.3330000](#) [SSL-LX20483ID](#) [SSL-LX3034YD](#) [SSL-LX5093LGT-11](#) [SSL-LX5093PGC](#) [SSL-LX5093SRC/F](#) [SSL-LX5093SYT](#) [SSL-LX5099SRSGC-CA](#) [SSL-LX509E3SIT](#) [SSL-LX509FT3ID](#)