

Specifications for BNC Connectors

BNC style connectors are miniature, light-weight, weatherproof interconnecting devices. Characterized by their two-stud, quick disconnect bayonet lock coupling arrangement. Their design functions satisfactorily from DC to 11 GHz in static applications, or from DC to 4GHz in applications involving vibration. The connectors typically yield a low VSWR (reflected signal) to 4GHz. Primary applications include Ten Base 2 LAN interconnections, radio telecommunications and broadcast equipment, medical equipment, computer, Precision Video, and test instrumentation where frequent coupling and decoupling are necessary. Bomar's BNCs are available in an extensive variety configurations and cable sizes and are impedance matched to either 50 ohm or 75 ohm.

MATERIALS

Connector Parts	Material	Equivalent Standard †
Connector Body and Parts	Brass	ISOCuZn38Pb2 Body Part
Male Contact Pin	Brass	QQ-B-626
Commercial Grade	Zinc Alloy/Brass	-----
Outer Contact	Brass	QQ-B-750
Socket Contact	Beryllium Cooper	QQ-C-530/MIL-H-7199
	Phosphor Bronze	CuBe2
Crimp Ferrule	Annealed Copper	QQ-C-576
Insulators, Standard Versions	Teflon	L-P403/BS4271
	Delrin	Grade B
Rubber Gaskets	Silicone Rubber	ASTM-E1418PSI
Plating	Nickel (Silver Optional)	MIL-G-45204

ELECTRICAL

Requirement	Performance		Test † Specification
	50 Ω	75 Ω	
Impedance	50 Ω	75 Ω	-----
Frequency Range	0-4 GHz	0-1 GHz	-----
VSWR	1.30 Max.		MIL- C-39012
RF Insertion Loss	0.2 dB Max. at 3 GHz		MIL- C-39012
RF Leakage	-55 dB Min. at 3 GHz		MIL- C-39012
Test Voltage (At Sea Level)	1500V rms		MIL-STD-202
Working Voltage (At Sea level)	500V rms		MIL-STD-202
Insulation Resistance	5000 Megohms Min.		MIL-STD-202
Contact Resistance	3 Milliohms Max.		MIL- C-39012

MECHANICAL & ENVIRONMENTAL

Requirement	Performance	Test † Specification
Durability	500 Insertions & Extractions Min.	MIL-C-39012
Shock	50 G	MIL-STD-202
Vibration	20 G from 80-2000 Hz	MIL-STD-202
Cable Retention (Cable Types)	60 lbs. Minimum Pull Test	MIL-C-39012
Coupling Nut	60 lbs. Maximum	MIL-C-39012
Temperature Range	Teflon: -55 to +199 C	-----
	Delrin: -40 to +85 C	-----
Moisture Resistance	Continuous Test	MIL-STD-202
Salt Spray	48 Hours	MIL-STD-202

†Products are made to conform to the Mil standard but are for commercial applications and are not QPL

3 Piece Crimp

BNC three piece crimp connectors feature semi-captive contacts that "click" into place assuring perfect installation. Each crimp pin has a vent hole for optional soldering. Soldering is recommended for all stranded conductors 26 AWG or smaller.

Part Number (Male)	"A" Dim. (I.D.)	Fig. No.	RG/U Cable
310A208A	.200 In.	Fig. 1	6, 21AWG Center Conductor
310A208A18	.200 In.	Fig. 1	6 CATV, 18AWG Center Conductor
310A205F	.124 In.	Fig. 1	58A/U, 58C/U Stranded, 141, Thin PVC
310A205FS	.124 In.	Fig. 1	58/U Solid Conductor
310A205FV	.125 In.	Fig. 2	58/U Thin-Net Plenum
310A205FV2	.125 In.	Fig. 2	Mini 59, RGB Cable (23 AWG)
310A205FV3	.125 In.	Fig. 2	Mini 59, RGB Cable (26 AWG)
310A204G	.150 In.	Fig. 1	59, 62, 210
310A205MV	.085 In.	Fig. 3	174, 178, 196, Mini RGB Cable
310A205N	.090 In.	Fig. 3	179, 187
310A205P	.125 In.	Fig. 1	223
310B205Q	.205 In.	Fig. 1	Belden 8281 True 75 Ohms
310A204T	.150 In.	Fig. 2	59, 62, Plenum
310A208W2	.103 In.	Fig. 1	Mini 59, RGB Cable (26 AWG)

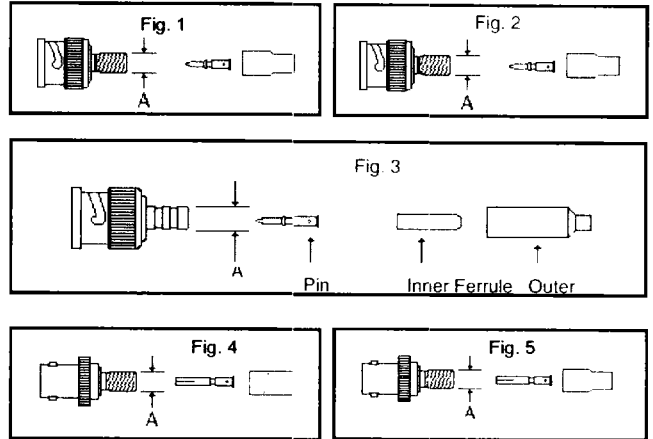

2 Piece Crimp

BNC 2 piece crimp connectors make use of a fully captivated pin. Just insert the center conductor into the connector body, slide the ferrule over the braid, and apply a single hex-crimp to the ferrule. These connectors are easy to install and reliable and are recommended only for the lower data transmission speeds.

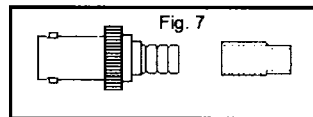
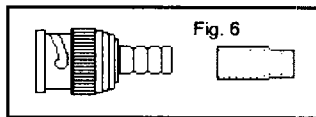

Part Number (Male)	Gender	Fig. No.	RG/U Cable
310X205F	Male	Fig. 6	RG58 (PVC)
310X205G	Male	Fig. 6	RG59, 62 (PVC)
320X205F	Female	Fig. 7	RG58 (PVC)
320X205G	Female	Fig. 7	RG59, 62 (PVC)

Twist-On

BNC Twist-On connectors are field installable and require no tooling other than a stripping tool for the cable preparation. The center conductor is inserted into Bomar's unique *Posi-Con*™ contact, as the connector is twisted onto the cable's outer jacket.

Part Number (Male)	Gender	Fig. No.	RG/U Cable
310A405A	Male	Fig. 8	6, Thicknet
310A405F	Male	Fig. 8	58A/U Solid Cond, 141, Thin PVC
310A405F1	Male	Fig. 8	58/U Solid Cond. - .172" - .178"
310A405F2	Male	Fig. 8	58/U Thin Plenum - .158" - .162"
310A405F3	Male	Fig. 8	Thin Plenum .150"
310A405G	Male	Fig. 8	59, 62, 210 PVC
310A405T	Male	Fig. 8	59, 62, 210 Plenum
320A405F	Female	Fig. 8A	58 Solid (PVC)
320A405G	Female	Fig. 8A	59, 62, 210 (PVC)

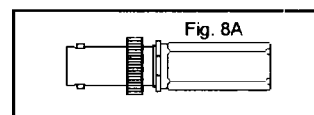
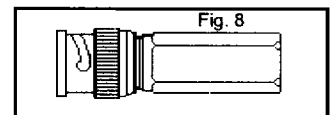

BNC Connectors

Standard Clamp

BNC standard clamp style is a simplified version of the original military clamp style. It is required that the contact be soldered to the center conductor of the cable.

Part Number	Gender	Fig. No.	RG/U Cable
310A105A	Male	9	6
310A105D	Male	9	11A
310A105F	Male	9	58, 58A, 58C, 141
310A105G	Male	9	59, 62, 214
310A105M*	Male	9	174, 188, 316
320A105F*	Female	10	58, 58A, 58C, 141
320A105G*	Female	10	59, 62, 214

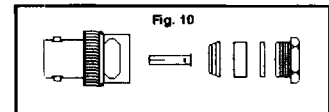
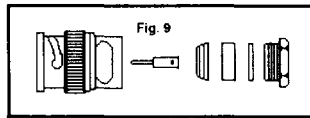

Taper Grip Clamp

BNC Taper Grip (or Wedge Clamp) style connectors require little cable preparation. Strip off all but a length of center conductor, push the taper under the cable's shield, solder the contact, and assemble.

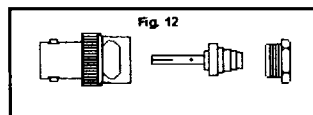
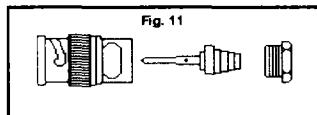

Part Number	Gender	Fig. No.	RG/U Cable
310A304A	Male	11	6
310A304F	Male	11	58, 58A, 58C, 141
310A304G	Male	11	59, 62, 214
310A304P	Male	11	223
320A304F*	Female	12	58, 58A, 58C, 141

Bulkhead Jacks

Versions are available for front mounting, (F/M) rear mounting, (R/M) crimp types, bulkhead mount grounded, or bulkhead mount, isolated. (Color-coded available. Red - Green - Blue) These jacks are held into the panel by a hex-nut and lockwasher. All units feature nickel plated, brass bodies, and gold phosphore-bronze contacts.

Part Number	Description	Fig. No.	Hole I. D.
321A245A	R/M Crimp, RG6	13	.500
321A245F	R/M Crimp, RG58, Thin-net PVC	13	.500
321A245FV	R/M Crimp, Thin-Net Plenum	14	.500
321A245G	R/M Crimp, RG59, 62, 214	13	.500
321A245M	R/M Crimp, RG174, 188, 196, 316	13	.500
321B245M*	R/M Crimp, RG174, 188, 196, 316	15	.500
321B245N*	R/M Crimp, RG179, 187	15	.500
326A515	F/M Solder (Grounded)	16	.375
326R515	F/M Solder (Isolated) White Bushing	17	.375
326R515RD	F/M Solder (Isolated) Red Bushing	17	.375
326R515GN	F/M Solder (Isolated) Green Bushing	17	.375
326R515BL	F/M Solder (Isolated) Blue Bushing	17	.375
326Q556	F/M Solder (Isolated) Metal Bushing	18	.500

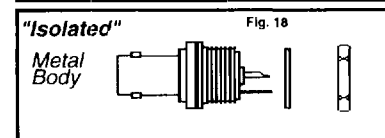
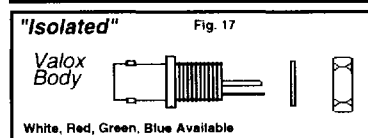
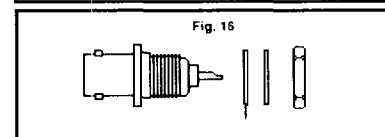
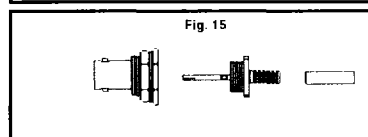
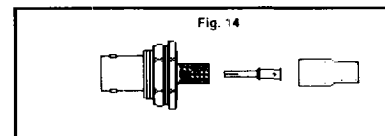
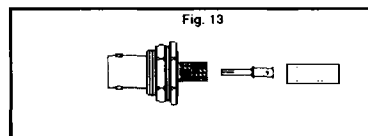

* Denotes that items are not popular and may require a special minimum order quantity requirement.

Panel Jacks & Plugs

BNC panel plugs and jacks are of machined brass construction for maximum reliability and quality. All contacts are plated with a minimum of five micro-inches of gold. The square panel types mount on .500 inch centers. The bulkhead type mounts into a .380 "D" shaped panel hole. All connector bodies are bright-nickel plated.

Part Number	Description	Notations	Fig. No.
316A524C	Male Bulkhead Panel Mount	.380" Mtg. Hole	19
317A507	Male Panel Mount	.500 Mtg. Hole Centers	20
321A205F	Female Panel Mount, Crimp	Fits RG58/U Cables	21
321A205G	Female Panel Mount, Crimp	Fits RG59, 62, 210 Cables	21
321A205M	Female Panel Mount, Crimp	Fits RG174, 178, 196	21
327A507	Female panel Mount, Solder	.500 Mtg. Hole Centers	22

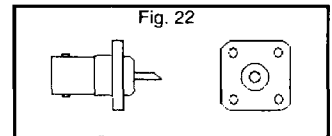
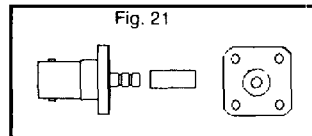
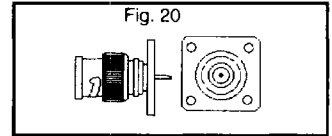
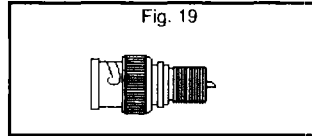

PC Board Vertical Jacks

BNC vertical mount jacks are available in straight PC mounts and "through-panel" styles. The "through-panel", 364 Series, is made in both isolated and grounded versions and are ideal for applications where multiple insertions will require a connector which can endure the stress of higher torque.

Part Number	Body Plating Or Material	Description	Insulator Material	Contact Plating	"L" Dim.	Fig. No.
361A514*	Nickel / Brass	Straight PC Mount 50 Ohms	Teflon	Gold	.717	26
361A505*	Nickel / Brass	Straight PC Mount 50 Ohms	Delrin	Gold	.830	27
361A534*	Nickel/Brass	3 Post PC Mount 50 Ohms	Delrin	Gold	.788	27A
364S595	White Valox	PC Mount, Thru-Panel, 50 Ohms	Delrin	Gold	1.36	23
364S595B	Black Valox	PC Mount, Thru-Panel, 50 Ohms	Delrin	Gold	1.36	24
364S599	White Valox	PC Mount, Thru-Panel, 50 Ohms	Delrin	Tin	1.36	23
364S595M	Nickel / Zinc	PC Mount, Thru-Panel, 50 Ohms	Delrin	Gold	1.36	25
364S599M	Nickel / Zinc	PC Mount, Thru-Panel, 50 Ohms	Delrin	Tin	1.36	25
364S795*	White Valox	PC Mount, Thru-Panel, 75 Ohms	Delrin	Gold	1.36	23
364S795B*	Black Valox	PC Mount, Thru-Panel, 75 Ohms	Delrin	Gold	1.36	24
364S795M*	Nickel / Zinc	PC Mount, Thru-Panel, 75 Ohms	Delrin	Gold	1.36	25
364NT	Nickel/Brass	Jam Nut (For All 364 Series)			.464	36N
364LW	Zinc/Steel	Lock washer (For All 364 Series)			.500	37N

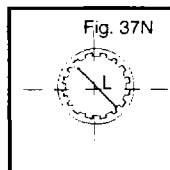
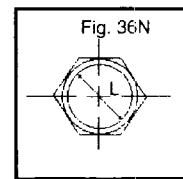
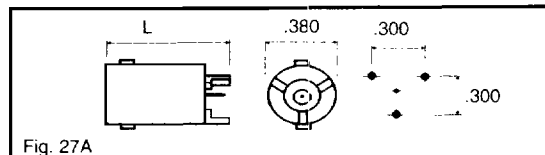
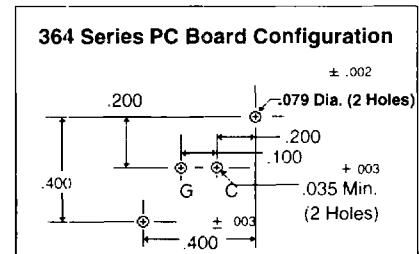
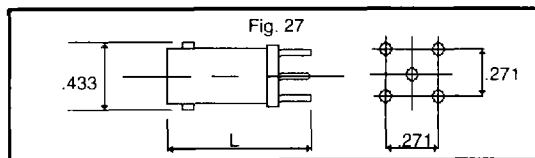
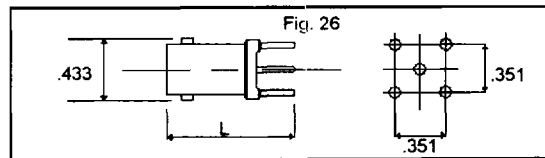
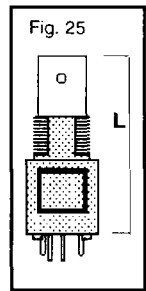
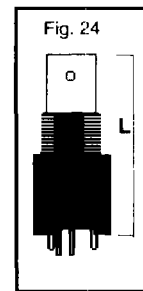
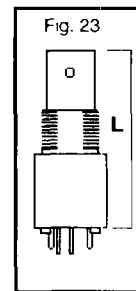

* Denotes that items are not popular and may require a special minimum quantity requirement

BNC Connectors

PC Board Right Angle Jacks

These BNC jacks are manufactured to the highest standards to assure stability in maintaining impedance matching at 50 ohm and 75 ohm applications. The 50 ohm versions have been approved by most of the U.S. manufacturers of LAN cards, and the 75 ohm is in wide use in *Precision Video* applications which require the use of a **True 75 ohm** connector. Contacts are phosphor bronze and will remain resilient even after hundreds of insertions.

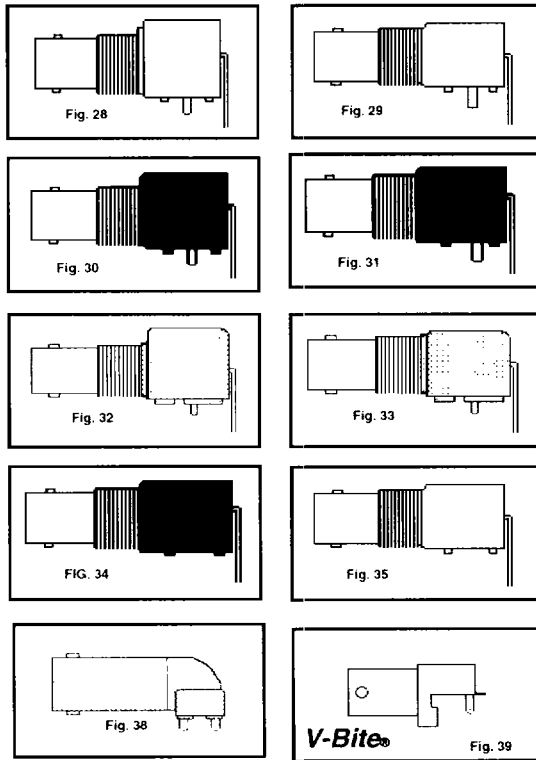

Part Number	Body Material	Description	Height F.M.S.	Contact Plating	Fig. No.
361V509E	Brass/Nickel	V-Bite® PC Edge Mount	.253	Gold	39
361V509ER	Brass/Nickel	As Above for Reflow Solder	.253	Gold	39
364M095	Nickel/Zinc	4 Post Low Profile, Metal	.453	Gold	38
364A595	White Valox	Standard Profile W/ Posts	.610	Gold	28
364A595NP*	White Valox	Standard Profile W/O Posts	.610	Gold	35
364A595B	Black Valox	Standard Profile W/ Posts	.610	Gold	30
364A595BNP*	Black Valox	Standard Profile W/O Posts	.610	Gold	35
364A595BL	White Valox	Low Profile W/ Posts	.515	Gold	29
364A595BLNP*	White Valox	Low Profile W/O Posts	.515	Gold	34
364A595BLB	Black Valox	Low Profile W/ Posts	.515	Gold	31
364A595BLBNP*	Black Valox	Low Profile W/O Posts	.515	Gold	34
364M595	Nickel / Zinc	Standard Profile W/ Posts	.620	Gold	32
364M595M	Nickel / Zinc	Super Low Profile W/ Clips	.340	Gold	35A
364M595L	Nickel / Zinc	Low Profile W/ Posts	.515	Gold	33
364A599	White Valox	Standard Profile W/ Posts	.610	Tin	28
364A599NP	White Valox	Standard Profile W/O Posts	.610	Tin	35
364A599B*	Black Valox	Standard Profile W/ Posts	.610	Tin	30
364A599BNP*	Black Valox	Standard Profile W/O Posts	.610	Tin	35
364A599BL	White Valox	Low Profile W/Posts	.515	Tin	31
364A599BLNP*	White Valox	Low Profile W/O Posts	.515	Tin	34
364A599BLB	Black Valox	Low Profile W/ Posts	.515	Tin	31
364A599BLBNP*	Black Valox	Low Profile W/O Posts	.515	Tin	34
364M599	Metal	Standard Profile W/ Posts	.620	Tin	32
364A795	White Valox	Standard Profile W/ Posts	.610	Gold	28
364A795B	Black Valox	Standard Profile W/ Posts	.610	Gold	30
364A795BL	White Valox	Low Profile W/ Posts	.515	Gold	29
364A795BLB	Black Valox	Low Profile W/ Posts	.515	Gold	31
364M795	Metal	Standard Profile W/ Posts	.620	Gold	32
364F595BL	White Valox	9400pF 500V Decoupled	.515	Gold	37
364F595BLB	Black Valox	9400 pF 500V Decoupled	.515	Gold	36
364H595BL	White Valox	9400 pF 1500V Decoupled	.515	Gold	37
364H595BLB	Black Valox	9400 pF 1500V Decoupled	.515	Gold	36

Capacitively Decoupled - These jacks are capacitively decoupled using two 4700 pF chip capacitors. This is a most cost effective way to efficiently filter out noise and to eliminate ground loops on coaxial interconnections

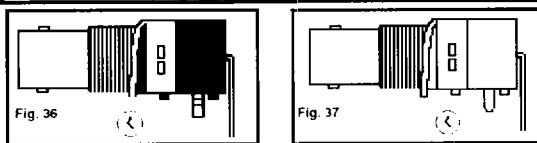

The Super Low Profile BNC PC jack reduces the amount of board space needed to mount a PC jack. Board clips hold the unit in place for soldering. The smallest, lowest profile BNC jack available.

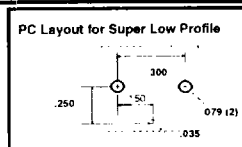
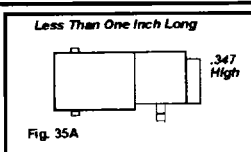

Board Clips Are Available In Place Of Posts. Add Suffix "C"



Spear-point clips lock snugly into the board.

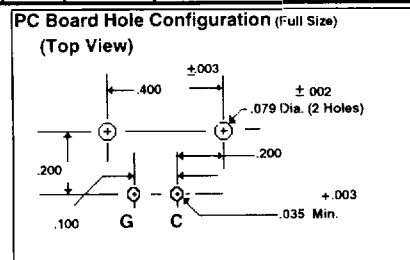

* Denotes that items are not popular and may require a special minimum order quantity

Adapters

These sturdy within-series BNC adapters are available in all standard designs. Additionally, several unique constructions compliment the product group and allow adaptations for every conceivable application. All connector bodies are plated with bright nickel. Male contacts are brass, female contacts are phosphor bronze. All contacts are plated with 5 micro inches of gold.

Part Number	Description	Fig. No.
330A505	Male/ Male Inline Barrel Splice	35
332A505	Female/Female Inline Splice	36
335A544	Female/Female Inline Bulkhead Mount (Grounded)	37
335R544	Female/Female Inline Isolated Bulkhead (Metal Outer Thread)	37
343A205F	Crimp "T" Adapter for RG58 Cable	41
343A205G	Crimp "T" Adapter for RG59, 62 Cables	41
343A505	Female/Male/Female "T" Adapter (Yes, it runs with Netware™)	38
345A505	Female/Female/Female "T" Adapter	39
351A505	Female/Male Right Angle Adapter	40
383U505	The Goalie™	42
383U205F	The Goalie Brute™ Crimp Version for RG58 Cable	45
383U205G	The Goalie Brute™ Crimp Version for RG59, 62 Cables	45
383K505	The Goalie Brute™	43
383P505	The Insulated Goalie	44
353U205F	Male/Female/Female Right Angle Double-Down™ Crimp Type for RG58	49
353U205G	Male/Female/Female Right Angle Double-Down™ Crimp Type for RG59	49
353U505	Male/Female/Female Right Angle Double-Down™	48
393U205F	Male/Female/Female Straight Double-Down™ Crimp Type for RG58	47
393U205G	Male/Female/Female Straight Double-Down™ Crimp Type for RG59	47
393U505	Male/Female/Female Straight Double-Down™	46

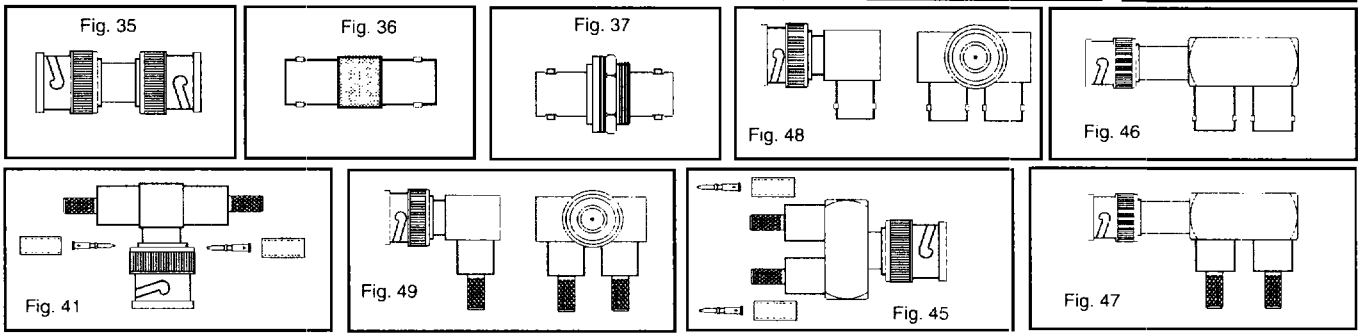
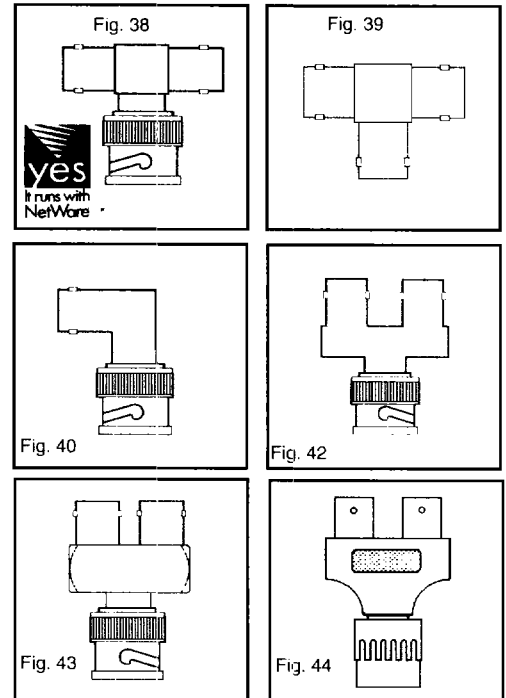

Specialty LAN Adapters

Double Down™ adapters are designed to allow parallel cables entering a patch panel, or a BNC LAN terminal port to be guided at a right angle to the input jack. Two versions accomplish this: one is a right angle with side-by-side jacks for areas with little rear clearance, and the other is a straight version for installations where width between panel jacks is limited. Crimp types are for permanent installations. **Goalie**, and **Goalie Brute** allow parallel cable 90° entry which require a minimum of rotational cable space.

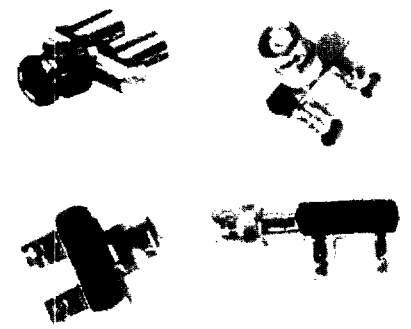

is a registered trademark of Novell, Inc. All other trademarks are the property of their respective owners.

BNC Connectors

Terminators

BNC terminators are available in standard 1% tolerance versions and in the economy 5% tolerance styles. The standard types have removable color coded caps for easy identification. The economy type are color coded as well but caps are not removable.

Part Number	Description	Fig. No.
310X054A	50 Ohm with Red Cap	50
310C054	50 Ohm with Grounding Chain	51
310X074	75 Ohm with Blue Cap	50
310X094	93 Ohm with Yellow Cap	50
EJ175	50 Ohm Economy, Green Cap	52
EJ177	75 Ohm Economy, Violet Cap	52
EJ179	93 Ohm Economy, White Cap	52

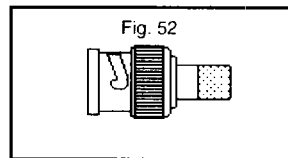
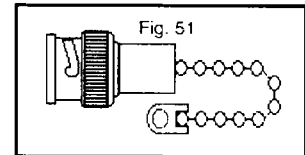
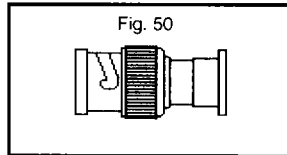

Self Terminating "T" Adapters

The **Safe "T"**™ adapter has the appearance of a standard "T" adapter but it has the ability to self-terminate when one of the attached mating plugs is removed. With the **Safe "T"**™ you need not buy separate terminators for Ethernet LANs. (as shown below) If a plug is accidentally removed, from either end, the systems remains "up" to the point of the disconnect because the 50 ohm precision resistor is automatically switched into use. The **Safe "T"**™ **Insulated** version is also available. Plastic is molded over the exposed metal areas of the "T" adapter. This attractive style is popular for European use. It is also self-terminating at either female end using a 1% precision resistor.

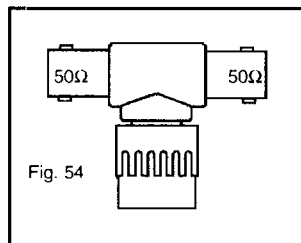
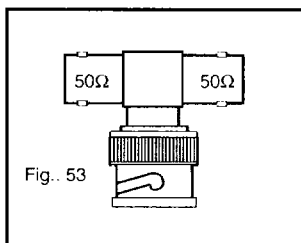

Part Number	Description	Fig. No.
343X505	Safe "T" ™ 50Ω Self-Terminating, F/M/F	53
343XP505	Safe "T" ™ Insulated 50Ω Self-Terminating, F/M/F	54

Cable Boots

Cable boots perform excellent strain relief from cable side-stress, and because they are available in several standard colors, allow for color coding of various cables at crowded patch panels. Standard PVC coax assemblies take on the look of a custom molded cable. All boots are for RG58, RG59, and RG62 PVC cables only.

Part Number	Description	Fig. No.	Part Number	Description	Fig. No.
CXB58A	RG58, Black, Ribbed	56	CXB62A	RG62, Black, Ribbed	56
CXB58ABL	RG58, Blue, Ribbed	56	CXB62ABL	RG62 Blue, Ribbed	56
CXB58AGN	RG58, Green, Ribbed	56	CXB62AGN	RG62, Green, Ribbed	56
CXB58ARD	RG58, Red, Ribbed	56	CXB62ARD	RG62, Red, Ribbed	56
CXB58AYL	RG58, Yellow, Ribbed	56	CXB62AYL	RG62, Yellow, Ribbed	56

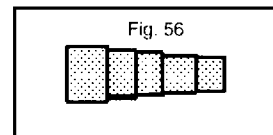

X-ON Electronics

Largest Supplier of Electrical and Electronic Components

Click to view similar products for [RF Connectors / Coaxial Connectors](#) category:

Click to view products by [Bomar Interconnect](#) manufacturer:

Other Similar products are found below :

[8915-1511-000](#) [89674-0827](#) [6001-7071-019](#) [6002-7051-003](#) [6002-7551-202](#) [6059674-1](#) [619550-1](#) [630059-000](#) [M39030/3-01N](#) [6500-7071-046](#) [6769](#) [CX050L2AQ](#) [7002-1541-010](#) [7002-1542-011](#) [7004-1512-000](#) [7009-1511-004](#) [7010-1511-000](#) [7029-1511-060](#) [7101-1541-010](#) [7101-1571-002](#) [7145-1521-002](#) [7203-1571-003](#) [7209-1511-011](#) [7210-1511-015](#) [7210-1511-019](#) [73137-5015](#) [73216-2241](#) [73404-2300](#) [7405-1521-005](#) [7405-1521-802](#) [8527](#) [8547](#) [FS11V](#) [877931](#) [8808-1511-001](#) [9049-9513-000](#) [9074-9513-000](#) [9101-9573-002](#) [910A205F](#) [9130-9573-002](#) [PL11SC-026](#) [PL375-33](#) [PL40-5](#) [PL74C-221](#) [PL75MC-217](#) [PL803-7](#) [1200690078](#) [1-201144-1](#) [R107003010W](#) [R110A172100](#)