

◆ SPECIFICATIONS

Unit:mm

- ◇ Poles: 2~16
- ◇ Applicable wire: AWG#28-#22
- ◇ Voltage rating: 250V DC/AC
- ◇ Current rating: 1.0A
- ◇ Withstand voltage: 500V AC
- ◇ Working Temperature: -25°C~+85°C
- ◇ Insulation resistance: $\geq 1000M\Omega$
- ◇ Contact resistance: $\leq 0.02\Omega$
- ◇ Applicable PC board thickness: 0.6~1.2mm

UL:Recognized No.E309635
RoHS-specification and Halogen-free products

ZH-nY

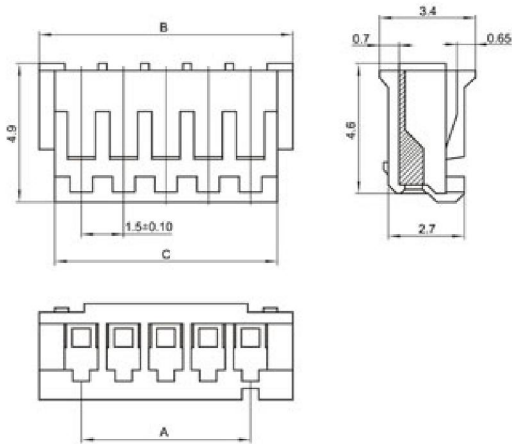

ZH-na

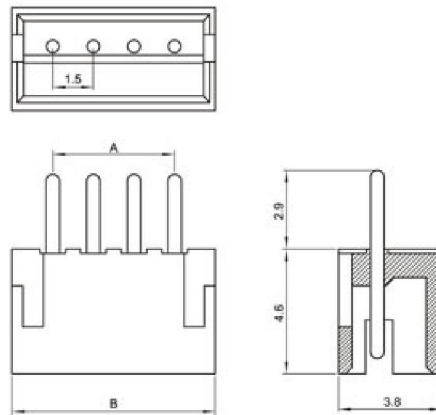

ZH-nAW

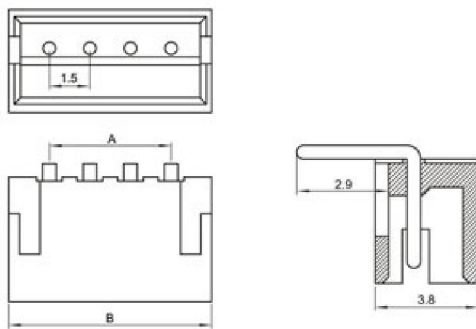

ZH-nAWD

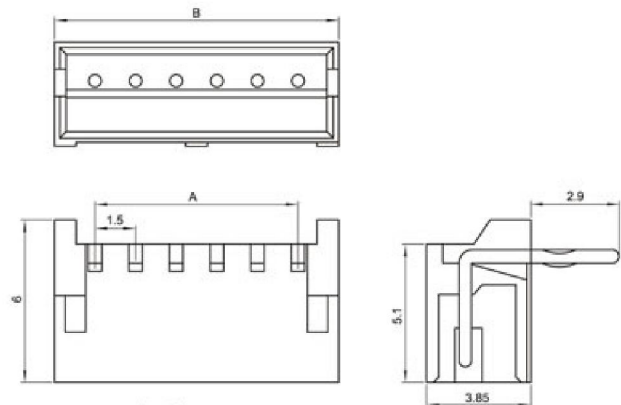

Unit:mm

ZH-na 卧贴



ZH-na 立贴



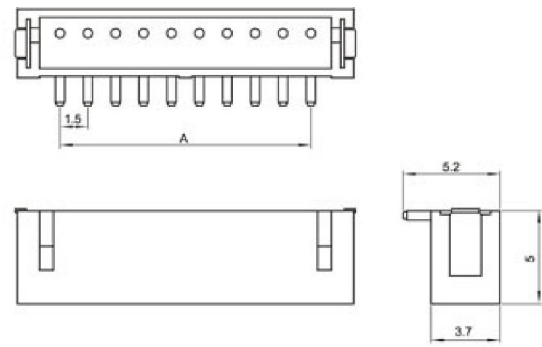
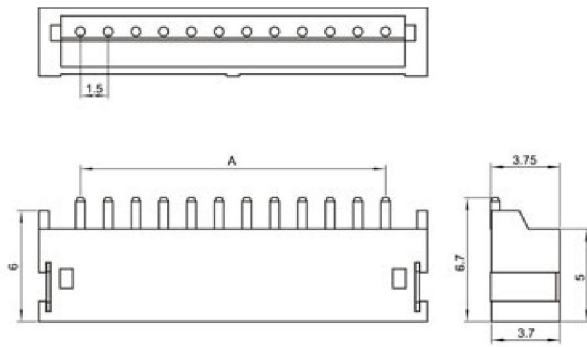

ZH-PT

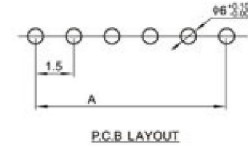
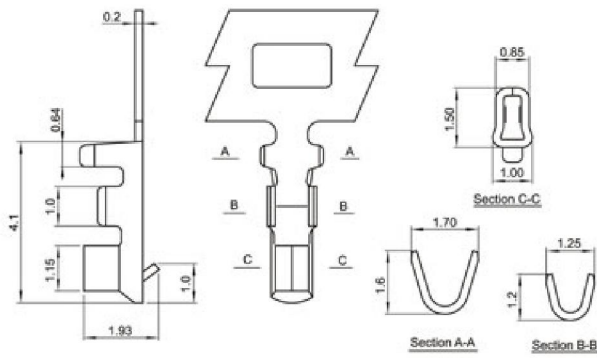

Terminal(ZH)

Type	Applicable wires		O.D of wire ins mm	Material	Finish
	mm ²	AWG#			
BM-ZH	0.08-0.3	28-22	1.2-1.9	Phos.bronze	Tin-plated

Poles	Type	Size(mm)			Poles	Type	Size(mm)	
		A	B	C			A	B
2	ZH-2Y	1.5	4.5	3.4	2	ZH-2A	1.5	4.5
3	ZH-3Y	3.0	6.0	4.9	3	ZH-3A	3.0	6.0
4	ZH-4Y	4.5	7.5	6.4	4	ZH-4A	4.5	7.5
5	ZH-5Y	6.0	9.0	7.9	5	ZH-5A	6.0	9.0
6	ZH-6Y	7.5	10.5	9.4	6	ZH-6A	7.5	10.5
7	ZH-7Y	9.0	12.0	10.9	7	ZH-7A	9.0	12.0
8	ZH-8Y	10.5	13.5	12.4	8	ZH-8A	10.5	13.5
9	ZH-9Y	12.0	15.0	13.9	9	ZH-9A	12.0	15.0
10	ZH-10Y	13.5	16.5	15.4	10	ZH-10A	13.5	16.5
11	ZH-11Y	15.0	18.0	16.9	11	ZH-11A	15.0	18.0
12	ZH-12Y	16.5	19.5	18.4	12	ZH-12A	16.5	19.5
13	ZH-13Y	18.0	21.0	19.9	13	ZH-13A	18.0	21.0
14	ZH-14Y	19.5	22.5	21.4	14	ZH-14A	19.5	22.5
15	ZH-15Y	21.0	24.0	22.9	15	ZH-15A	21.0	24.0
16	ZH-16Y	22.5	25.5	24.4	16	ZH-16A	22.5	25.5

X-ON Electronics

Largest Supplier of Electrical and Electronic Components

Click to view similar products for [Headers & Wire Housings](#) category:

Click to view products by [Boom](#) manufacturer:

Other Similar products are found below :

[57102-F02-18ULF](#) [58102-G61-06LF](#) [0009485154](#) [009176003701906](#) [0050291907](#) [02.125.8002.8](#) [609-3404](#) [61062-3](#) [622-0430](#) [622-3653LF](#)
[63453-116](#) [636-1030](#) [636-1427](#) [636-3427](#) [636-4007](#) [641938-9](#) [644827-2](#) [65495-038](#) [65692-001LF](#) [65781-018](#) [65781-047](#) [65817-010LF](#)
[65817-015LF](#) [66207-023LF](#) [67016-026LF](#) [67095-007LF](#) [68631-112](#) [68645-018](#) [68648-049](#) [699319-000](#) [70.362.1628.0](#) [70-4210](#) [70-4226B](#)
[70-4853B](#) [707-5020](#) [707-5028](#) [71.350.2428.0](#) [71961-016LF](#) [733-134](#) [754199-000](#) [760-3052](#) [787-8014-00](#) [FCN-367T-T012/H](#) [80.063.4001.1](#)
[800-90-010-10-002000](#) [801-43-002-10-013000](#) [801-43-006-10-002000](#) [803-41-018-10-001000](#) [803-43-014-20-001000](#) [803-43-024-10-001000](#)