

SPECIFICATIONS

Unit:mm

- ◇ Poles: 2~16
- ◇ Applicable wire: AWG#28-#22
- ◇ Voltage rating: 125V DC/AC
- ◇ Current rating: 1.0A
- ◇ Withstand voltage: 500V AC
- ◇ Working Temperature: -25°C ~ +85°C
- ◇ Insulation resistance: $\geq 1000M\Omega$
- ◇ Contact resistance: $\leq 0.03\Omega$
- ◇ Applicable PC board thickness: 0.6~1.2mm

UL:Recognized No.E309635
 RoHS-specification and
 Halogen-free products

1.25T-2-nA 卧贴

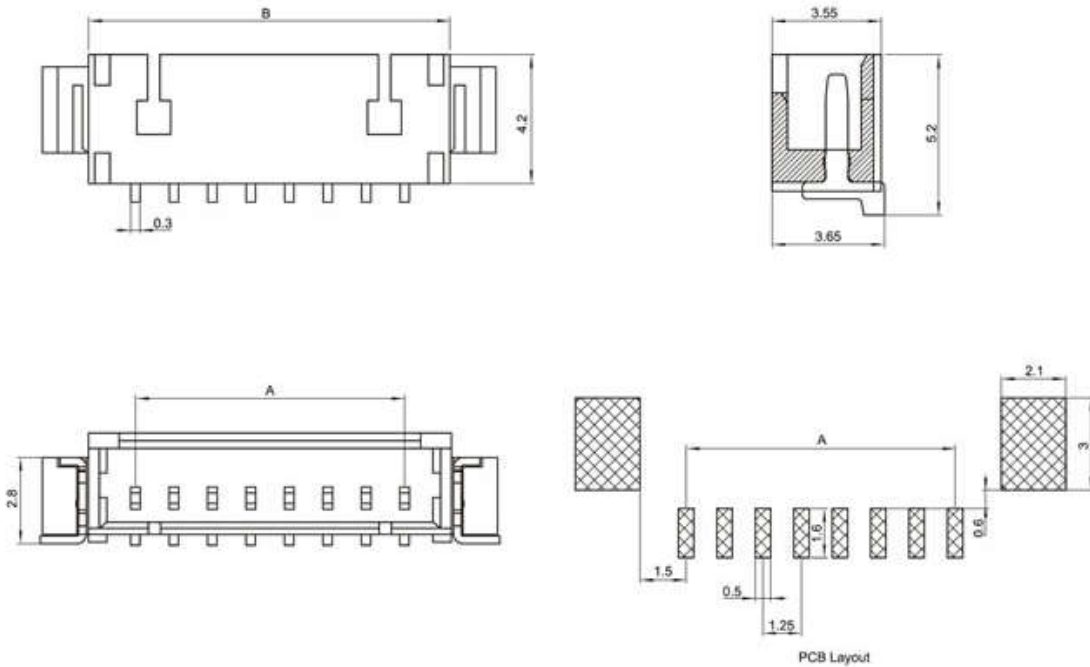

1.25T-2-nA 立贴

Unit:mm

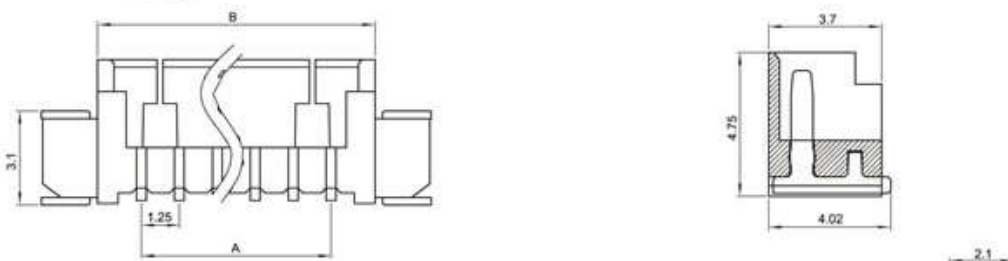

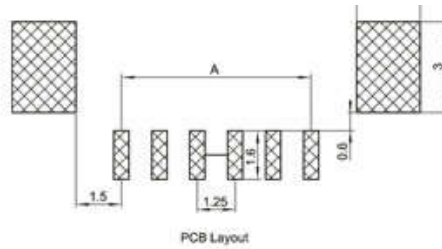
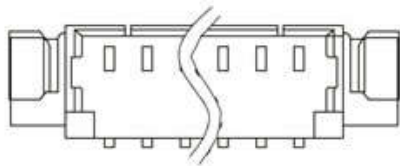

1.25T-2-nY

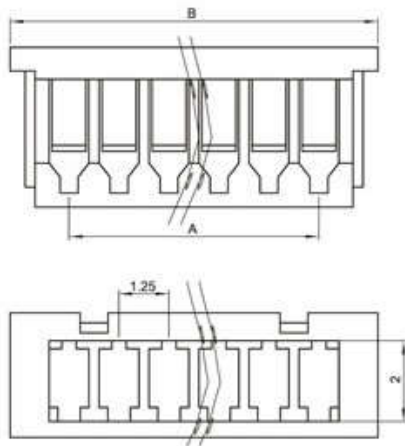

Mounting Measurement

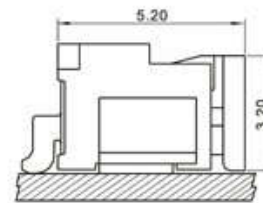
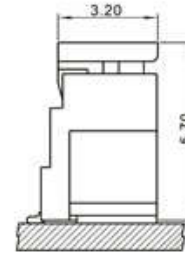

1.25T-1-PT

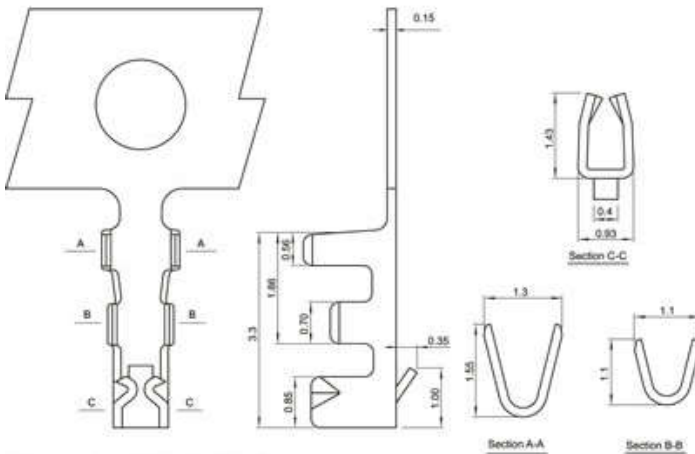

Poles	Type	Size(mm)	
		A	B
2	1.25T-2-2A	1.25	4.25
3	1.25T-2-3A	2.50	5.50
4	1.25T-2-4A	3.75	6.75
5	1.25T-2-5A	5.00	8.00
6	1.25T-2-6A	6.25	9.25
7	1.25T-2-7A	7.50	10.50
8	1.25T-2-8A	8.75	11.75
9	1.25T-2-9A	10.00	13.00
10	1.25T-2-10A	11.25	14.25
11	1.25T-2-11A	12.50	15.50
12	1.25T-2-12A	13.75	16.75
13	1.25T-2-13A	15.00	18.00
14	1.25T-2-14A	16.25	19.25
15	1.25T-2-15A	17.50	20.50
16	1.25T-2-16A	18.75	21.75

Poles	Type	Size(mm)	
		A	B
2	1.25T-2-2Y	1.25	4.2
3	1.25T-2-3Y	2.50	5.45
4	1.25T-2-4Y	3.75	6.7
5	1.25T-2-5Y	5.00	7.95
6	1.25T-2-6Y	6.25	9.2
7	1.25T-2-7Y	7.50	10.45
8	1.25T-2-8Y	8.75	11.7
9	1.25T-2-9Y	10.00	12.95
10	1.25T-1-10Y	11.25	14.2
11	1.25T-1-11Y	12.50	15.45
12	1.25T-1-12Y	13.75	16.7
13	1.25T-1-13Y	15.00	17.95
14	1.25T-1-14Y	16.25	19.2
15	1.25T-1-15Y	17.50	20.45
16	1.25T-1-16Y	18.75	21.7

Terminal(1.25T-1)

Type	Applicable wires		O.D of wire ins mm	Material	Finish
	mm ²	AWG#			
1.25T-1	0.8~0.3	32~28	0.8mm(max)	Phos.bronze	Tin-plated

X-ON Electronics

Largest Supplier of Electrical and Electronic Components

Click to view similar products for [Headers & Wire Housings](#) category:

Click to view products by [Boom](#) manufacturer:

Other Similar products are found below :

[57102-F02-18ULF](#) [58102-G61-06LF](#) [0009485154](#) [009176003701906](#) [0050291907](#) [02.125.8002.8](#) [609-3404](#) [61062-3](#) [622-0430](#) [622-3653LF](#)
[63453-116](#) [636-1030](#) [636-1427](#) [636-3427](#) [636-4007](#) [641938-9](#) [644827-2](#) [65495-038](#) [65692-001LF](#) [65781-018](#) [65781-047](#) [65817-010LF](#)
[65817-015LF](#) [66207-023LF](#) [67016-026LF](#) [67095-007LF](#) [68631-112](#) [68645-018](#) [68648-049](#) [699319-000](#) [70.362.1628.0](#) [70-4210](#) [70-4226B](#)
[70-4853B](#) [707-5020](#) [707-5028](#) [71.350.2428.0](#) [71961-016LF](#) [733-134](#) [754199-000](#) [760-3052](#) [787-8014-00](#) [FCN-367T-T012/H](#) [80.063.4001.1](#)
[800-90-001-10-001000](#) [800-90-010-10-002000](#) [801-43-002-10-013000](#) [801-43-006-10-002000](#) [803-41-018-10-001000](#) [803-43-014-20-](#)
[001000](#)