

XHB料号命名规则

XHB Part No. Naming Rules

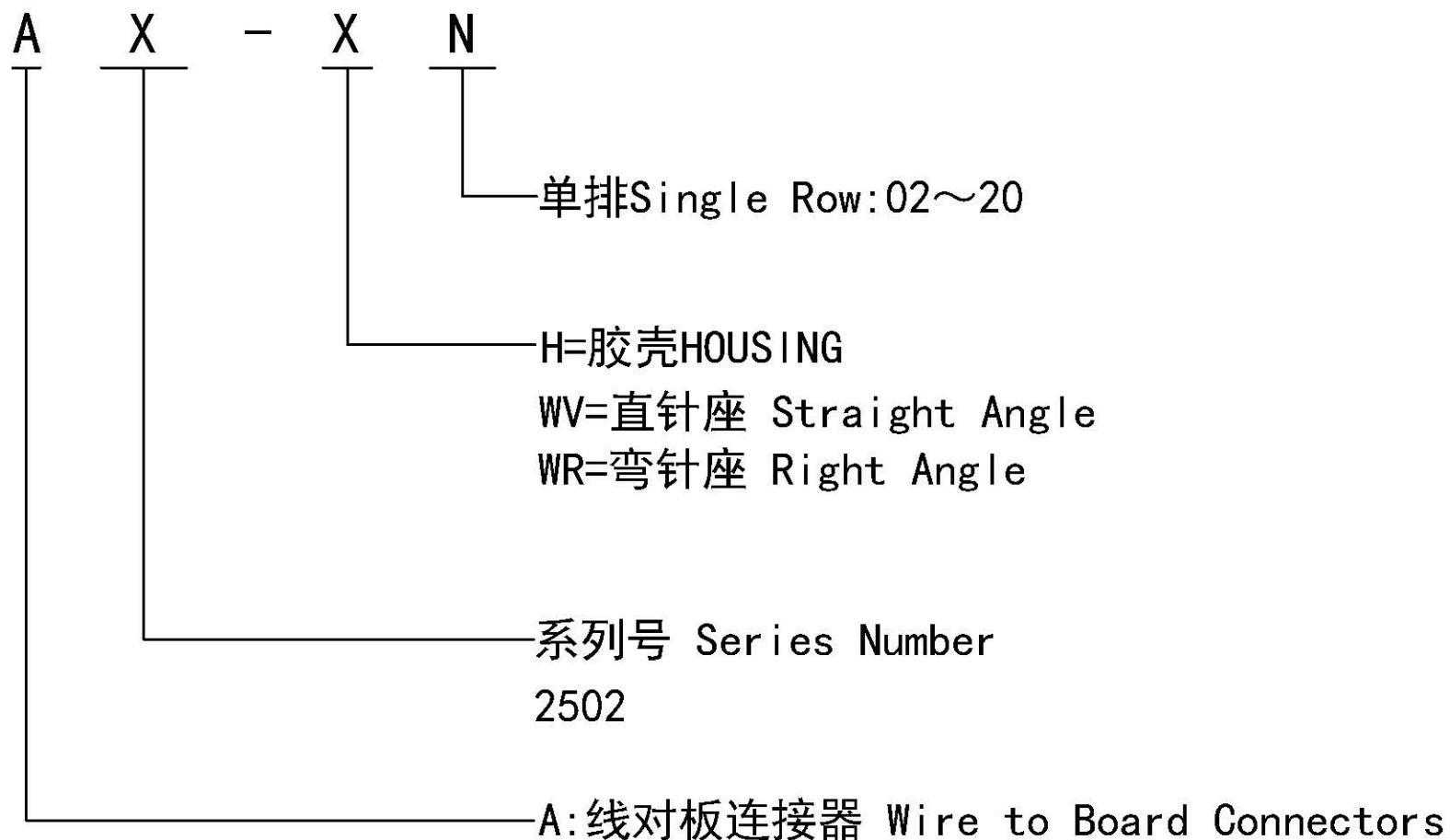

XHB连接器承认图面

REV	DESCRIPTION	DATE
A/0	原始版本	E
A/1	修订版本	

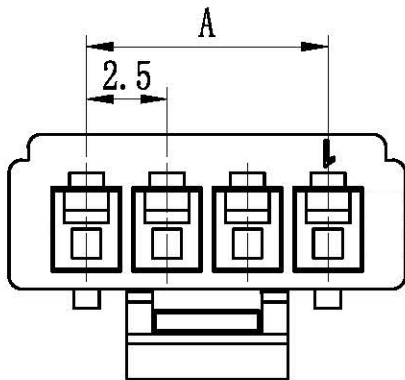
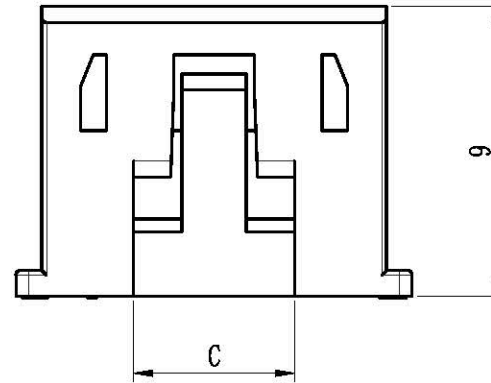
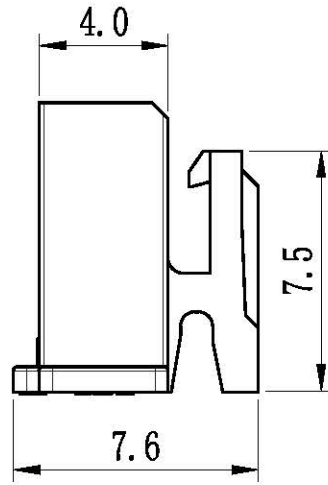
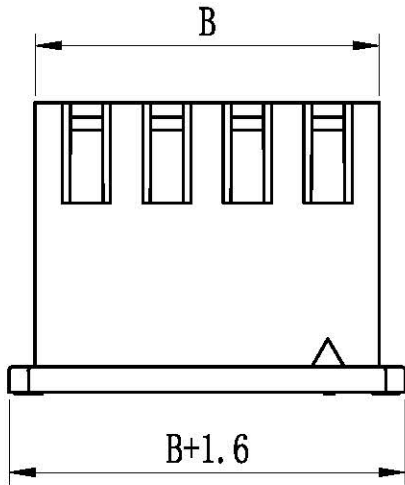

范围	>0~3	>3~18	>18~50	>50~120
公差	±0.12	±0.15	±0.3	±0.5

Poles	Part No.	Dimensions mm		
		A	B	C
2	A2502-H02	2.5	5.7	3
3	A2502-H03	5.0	8.2	4
4	A2502-H04	7.5	10.7	5
5	A2502-H05	10.0	13.2	7.5
6	A2502-H06	12.5	15.7	10
7	A2502-H07	15.0	18.2	12.5
8	A2502-H08	17.5	20.7	12.5
9	A2502-H09	20.0	23.2	12.5
10	A2502-H10	22.5	25.7	12.5
11	A2502-H11	25.0	28.2	12.5
12	A2502-H12	27.5	30.7	12.5
13	A2502-H13	30.0	33.2	12.5
14	A2502-H14	32.5	35.7	12.5
15	A2502-H15	35.0	38.2	12.5
16	A2502-H16	37.5	40.7	12.5
8	A2502-HB08	17.5	20.7	15
9	A2502-HB09	20.0	23.2	17.5
10	A2502-HB10	22.5	25.7	17.5
11	A2502-HB11	25.0	28.2	17.5
12	A2502-HB12	27.5	30.7	17.5
--	--	--	--	--
20	A2502-WV20	47.5	50.7	17.5

1		Housing 胶壳	PA66 (UL94V-0/V-2)	1	White (白色)
序号	图号	名称	材料	数量	附注
未注公差					
X.° ±3° X.X° ±0.5°					
<10	10-30	>30	单位	比例	Design Units
±0.2	±0.25	±0.3	MM Only	—	METRIC
制作	审核	批准	材料	图号	SIZE
			见图解	品名	页码
					1 OF 1
					Part No
					XHB-NY

旧底图总号
底图总号
签字
日期

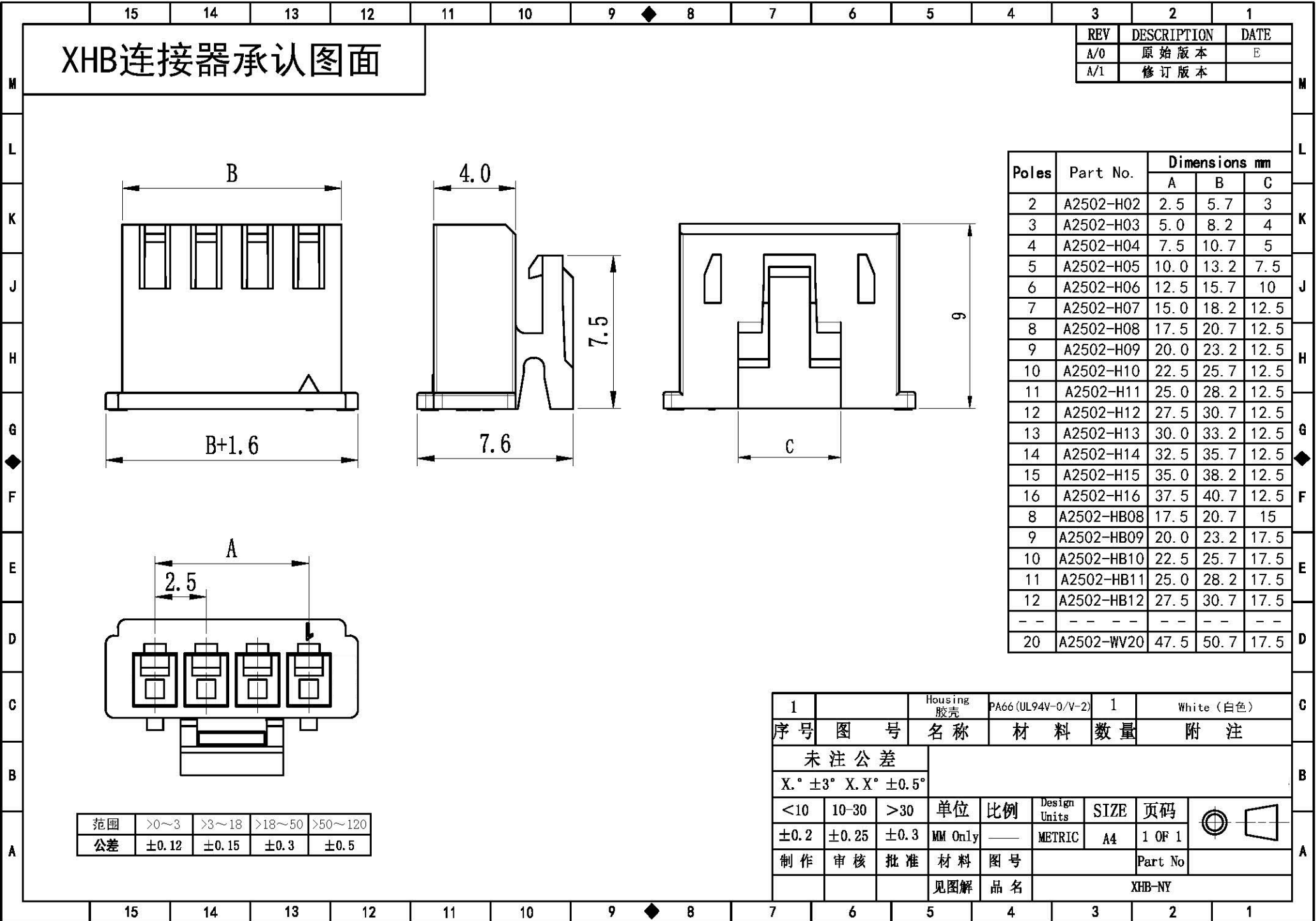

XH端子承认图面

REV	DESCRIPTION	DATE
A/0	原始版本	E
A/1	修订版本	

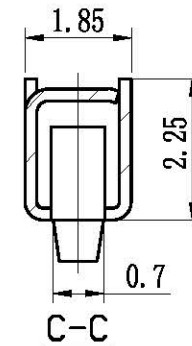
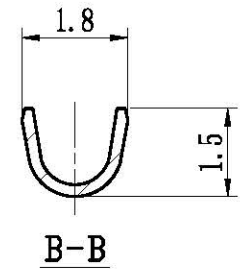
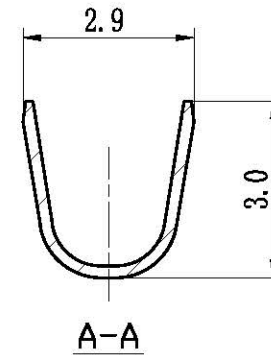
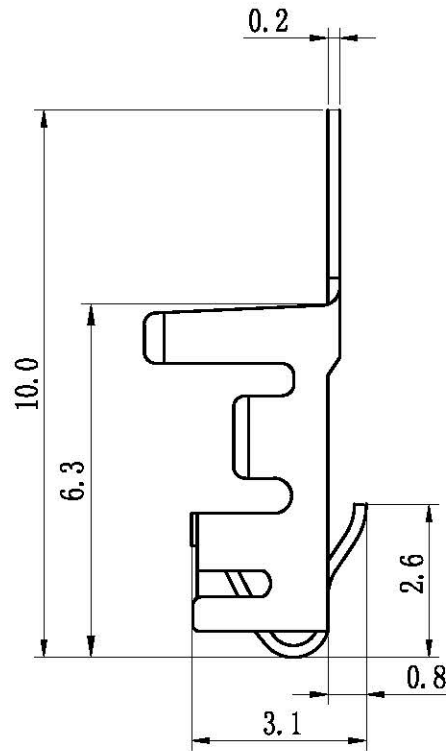
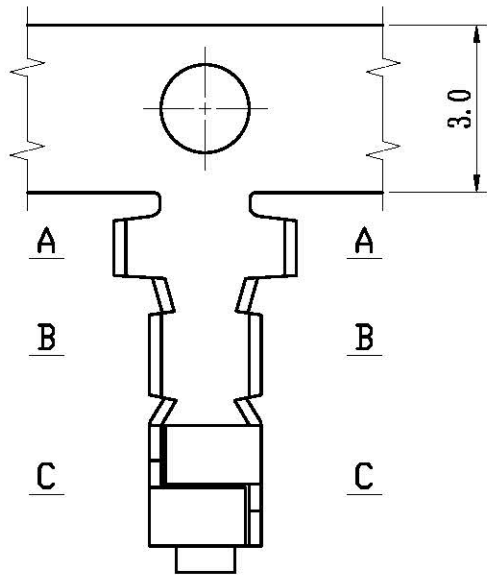

主要技术参数 Main Specifications

线数 (poles): 2 to 20P
 额定电流 (Current rating): 3.0A AC, DC
 额定电压 (Voltage rating): 250V AC, DC
 温度范围 (Temperature range): -25°C to +85°C
 接触电阻 (Contact resistance): $\leq 20\text{m}\Omega$
 绝缘电阻 (Insulation resistance): $\geq 1000\text{M}\Omega$
 耐电压 (Withstand voltage): 1000V AC/minute
 适用线规 (Applicable wire): AWG #28 to #22
 适用基板厚度 (Applicable PC board thickness): 1.2~1.6mm

范围	>0~3	>3~18	>18~50	>50~120
公差	± 0.12	± 0.15	± 0.3	± 0.5

1	A2501-T11	Phos Bronze tin 磷青铜镀锡	T11/T12	6000PCS/Roll (1盘)
序号	料号	材料	附注	
未注公差				
X.° $\pm 3^\circ$ X.X° $\pm 0.5^\circ$				
<10	10-30	>30	单位	比例
± 0.2	± 0.25	± 0.3	MM Only	—
制作	审核	批准	材料	图号
			见图解	品名
				XH-T11

旧底图总号

底图总号

签字

日期

XH端子承认图面

REV	DESCRIPTION	DATE
A/0	原始版本	E
A/1	修订版本	

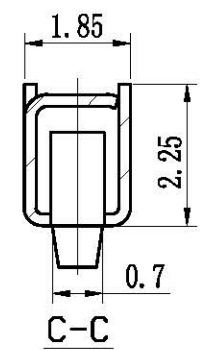
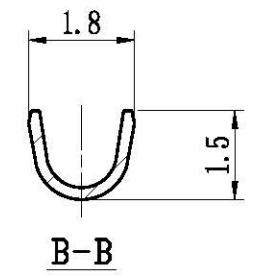
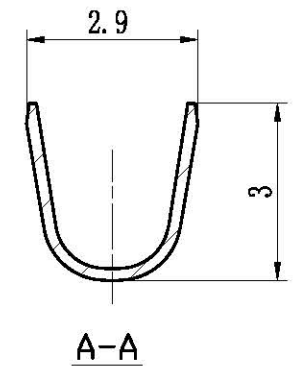
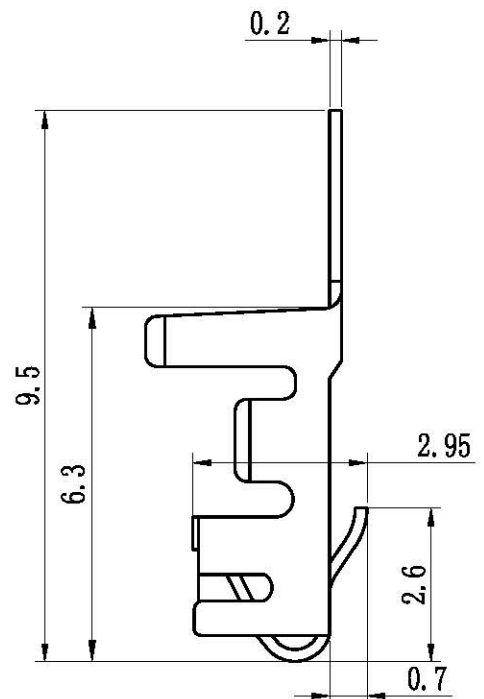
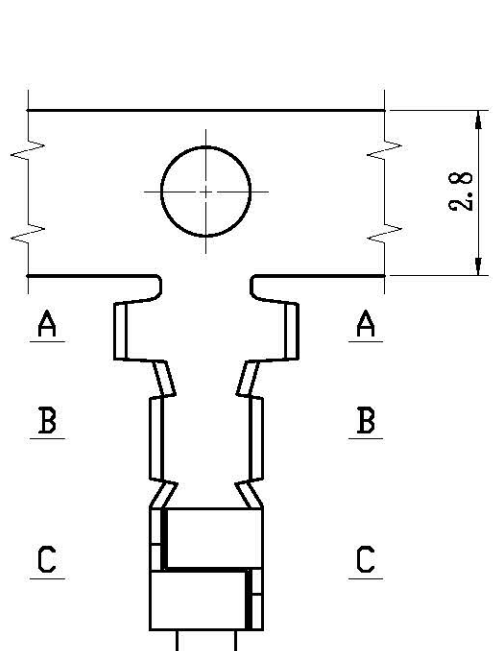

主要技术参数 Main Specifications

线数 (poles): 2 to 20P
 额定电流 (Current rating): 3.0A AC, DC
 额定电压 (Voltage rating): 250V AC, DC
 温度范围 (Temperature range): -25°C to +85°C
 接触电阻 (Contact resistance): $\leq 20\text{m}\Omega$
 绝缘电阻 (Insulation resistance): $\geq 1000\text{M}\Omega$
 耐电压 (Withstand voltage): 1000V AC/minute
 适用线规 (Applicable wire): AWG #28 to #22
 适用基板厚度 (Applicable PC board thickness): 1.2~1.6mm

范围	>0~3	>3~18	>18~50	>50~120
公差	± 0.12	± 0.15	± 0.3	± 0.5

1	A2501-T21	Phos Bronze tin 磷青铜镀锡	T21	6000PCS/Roll (1盘)
序号	料号	材料	附注	
未注公差				
$X.^{\circ} \pm 3^{\circ}$ X.X $^{\circ} \pm 0.5^{\circ}$				
<10	10-30	>30	单位	比例
± 0.2	± 0.25	± 0.3	MM Only	—
制作	审核	批准	材料	图号
			见图解	品名
XH-T21				

旧底图总号
 底图总号
 签字
 日期

XHB连接器承认图面

REV	DESCRIPTION	DATE
A/0	原始版本	E
A/1	修订版本	

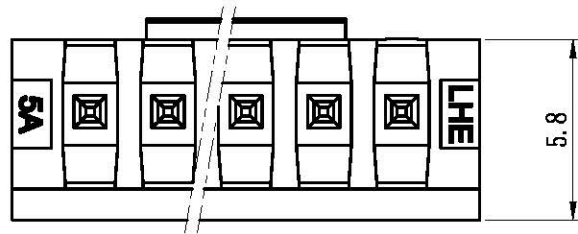
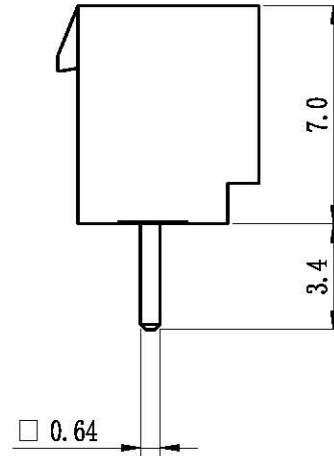
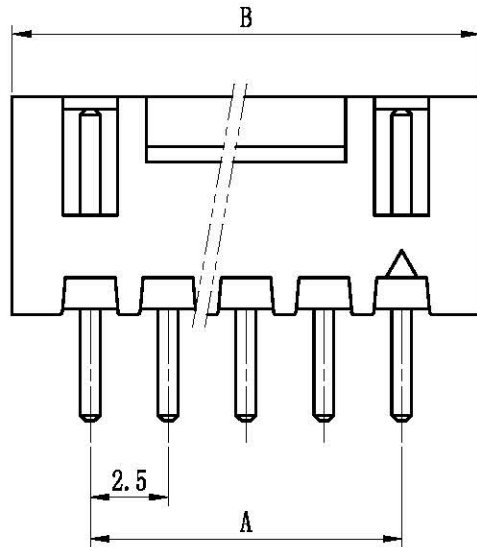

Poles	Part No.	Dimensions mm	
		A	B
2	A2502-WV02	2.50	7.50
3	A2502-WV03	5.00	10.00
4	A2502-WV04	7.50	12.50
5	A2502-WV05	10.00	15.00
6	A2502-WV06	12.50	17.50
7	A2502-WV07	15.00	20.00
8	A2502-WV08	17.50	22.50
9	A2502-WV09	20.00	25.00
10	A2502-WV10	22.50	27.50
11	A2502-WV11	25.00	30.00
12	A2502-WV12	27.50	32.50
13	A2502-WV13	30.00	35.00
14	A2502-WV14	32.50	37.50
15	A2502-WV15	35.00	40.00
16	A2502-WV16	37.50	42.50
--	--	--	--
20	A2502-WV20	47.50	52.50

范围	>0~3	>3~18	>18~50	>50~120
公差	±0.12	±0.15	±0.3	±0.5

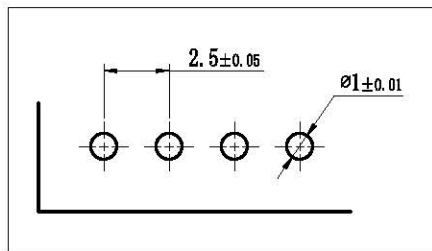

P. C. B LAYOUT

2	Wafer 针	Brass Tin 黄铜镀锡	N					
1	Housing 基座	PA66 (UL94V-0/V-2)	1	White (白色)				
序号	图号	名称	材料	数量	附注			
未注公差								
X.° ±3° X.X° ±0.5°								
<10	10-30	>30	单位	比例	Design Units	SIZE	页码	
±0.2	±0.25	±0.3	MM Only	—	METRIC	A4	1 OF 1	
制作	审核	批准	材料	图号	Part No			
			见图解	品名	XHB-NA			

旧底图总号
底图总号
签字
日期

Grid coordinates: 15, 14, 13, 12, 11, 10, 9, 8, 7, 6, 5, 4, 3, 2, 1 (horizontal); M, L, K, J, H, G, F, E, D, C, B, A (vertical)

XHB连接器承认图面

REV	DESCRIPTION	DATE
A/0	原始版本	E
A/1	修订版本	

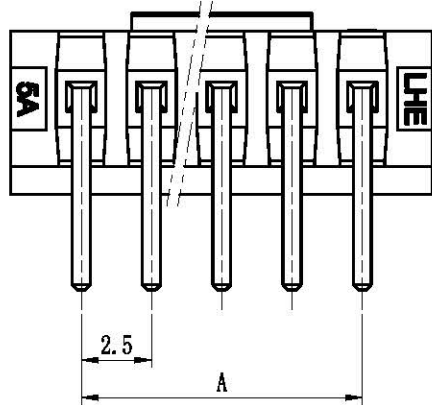
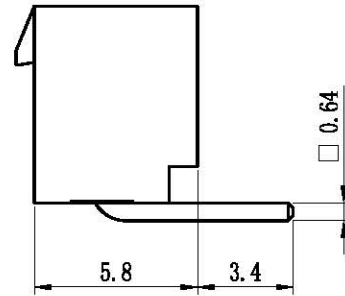
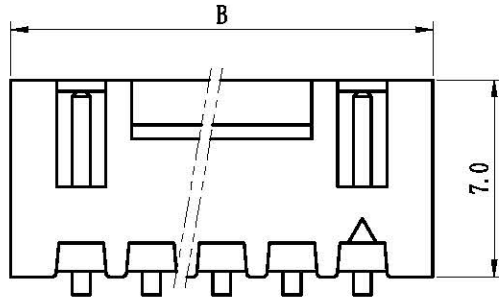

Poles	Part No.	Dimensions mm	
		A	B
2	A2502-WR02	2.50	7.50
3	A2502-WR03	5.00	10.00
4	A2502-WR04	7.50	12.50
5	A2502-WR05	10.00	15.00
6	A2502-WR06	12.50	17.50
7	A2502-WR07	15.00	20.00
8	A2502-WR08	17.50	22.50
9	A2502-WR09	20.00	25.00
10	A2502-WR10	22.50	27.50
11	A2502-WR11	25.00	30.00
12	A2502-WR12	27.50	32.50
13	A2502-WR13	30.00	35.00
14	A2502-WR14	32.50	37.50
15	A2502-WR15	35.00	40.00
16	A2502-WR16	37.50	42.50
--	--	--	--
20	A2502-WR20	47.50	52.50

范围	>0~3	>3~18	>18~50	>50~120
公差	±0.12	±0.15	±0.3	±0.5

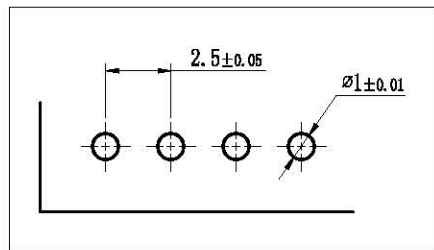

P. C. B LAYOUT

2		Water 针	Brass Tin 黄铜镀锡	N	
1		Housing 基座	PA66 (UL94V-0/V-2)	1	White (白色)
序号	图号	名称	材料	数量	附注
未注公差					
X.° ±3° X.X° ±0.5°					
<10	10-30	>30	单位	比例	Design Units
±0.2	±0.25	±0.3	MM Only	—	METRIC
			SIZE	页码	
			A4	1 OF 1	
制作	审核	批准	材料	图号	Part No
			见图解	品名	XHB-NAW

旧底图总号
底图总号
签字
日期

M
L
K
J
H
G
F
E
D
C
B
A

M
L
K
J
H
G
F
E
D
C
B
A

15 14 13 12 11 10 9 8 7 6 5 4 3 2 1

15 14 13 12 11 10 9 8 7 6 5 4 3 2 1

- ◆5、接触电阻 Contact resistance: $\leq 20\text{m}\Omega$
- ◆6、绝缘电阻 Insulation resistance: $\geq 1000\text{M}\Omega$
- ◆7、耐电压 Withstand voltage: 1000V AC/minute
- ◆8、适用线规 Applicable wire: AWG #30 to #22
- ◆9、适用基板厚度 Applicable PC board thickness: 1.6mm

产品性能测试 Performance test			
	项目 Item	测试条件 Test Condition	规格要求 Requirement
1	外观 Appearance	目测 Visual by eye 视力 Light: >1.0 照明 Lamp: 200~300Lx 目测距离 Space: 0.3~0.5m	1. 塑料件表面应无明显疤痕、凹陷、开裂及影响使用的变形。 Plastic part: smooth and flat surface without discolor, broken, crack distortion defects is acceptable. 2. 金属件表面无锈蚀、氧化、无明显的机械损伤等缺陷。 Metal part: tight and even surface without rust, oxide, fog and obvious physical damage defects is acceptable. 3. 导线表面清洁、无破损等缺陷, 印字及标志清晰。 Wire: clearing surface without discolor, broken defects, indistinct words and mark is acceptable.
2	接触电阻 Contact Resistance	插合连接器, 用小功率电路进行测试。 Mate connectors, measure by dry circuit.	20m Ω MAX
3	绝缘电阻 Insulation Resistance	在相邻接触件之间或地线之间, 用500V DC电压进行测试。 Apply 500V DC between adjacent terminal or ground.	1000M Ω MIN
4	耐电压 Dielectric Strength	相邻接触件之间或地线之间施加50Hz 1000V AC(有效值), 漏电流1mA的电压作用, 时间1min。 Mate connectors, apply 1000V AC for 1 minute between adjacent terminal or ground.	无击穿和飞弧现象 No Breakdown

5	压着部位抗张强度 Crimping Pull Out Force	轴线方向施加张力,速度不大于25mm/min。 Fix the crimped terminal, apply axial pull out force on the wire at the speed rate of not more 25mm/min.	AWG. 26#	20N MIN
			AWG. 28#	10N MIN
			AWG. 30#	5N MIN
6	壳体/端子固定力 Terminal/Housing Retention Force	固定连接器或测力计, 在连接器轴线方向施 加规定的拉力;速度不大于25mm/min。 Apply axial pull out force at the speed rate of not more 25mm/min on the pin assembled in the housing.	10N MIN	
7	针的固定力 Pin Retention Force	固定连接器或测力计, 在连接器轴线方向对 针施加规定的推力;速度不大于25mm/min。 Apply axial push out force at the speed rate of not more 25mm/minute on the terminal assembled in the base.	10N MIN	
8	可焊性 Solderability	把测试样品需要焊接的部位浸入焊锡炉中 (锡炉温度240°C±5°C) 2±0.5s秒钟。 Soldering time: 2±0.5s second Solder Temperature: 240°C±5°C	上锡率≥90% 90% of immersed area must show no voids, pin holes	
9	耐焊接热 Resistance to Soldering Heat	把测试样品需要焊接的部位浸入焊锡炉中 (锡炉温度260°C±5°C); 4~6秒钟后在正常 的条件下恢复1小时。 Soldering time: 4~6 second Solder Temperature: 260°C±5°C	外观 Appearance	无损伤 No Damage
10	耐高温 Heat Resistance	连接器配合后, 于85°C±2°C的空气中放置4 小时, 然后再回到室温中放置1~2h小时测 定 Mated connectors are exposed to a temperature of 85°C±2°C for 4 hours.	外观 Appearance 接触电阻 LLCR	无损伤 No Damage 40mΩ Max
11	耐低温 Cold Resistance	连接器配合后, 于-25°C±2°C的空气中放置 4小时, 然后再回到室温中放置1~2h小时测 定 Mated connectors are exposed to a temperature of -25°C±2°C for 4 hours.	外观 Appearance 接触电阻 LLCR	无损伤 No Damage 40mΩ Max
12	温度上升 Temperature Rise	插合连接器, 通以最大允许电流。 Carrying rated current load.	温度最大上升 Temperature Rise	60°C MAX

13	恒定湿热 Humidity	相对湿度: 90%~95% 搁置时间: 96小时, 取出恢复2h后检查 Temperature: 40±2°C Relative Humidity: 90%~95% Duration: 96 hours	接触电阻 LLCR	40mΩ Max
			绝缘电阻 Insulation Resistance	500MΩ Min
14	温度循环 Temperature cycle	把测试样品放入高低温试验箱中, 按下列步骤调试温度: a) 在-25°C±2°C的恒温条件下放置0.5小时; b) 在85°C±2°C的恒温条件下放置0.5小时; 从a)到b)为一个循环周期, 共进行5个循环。 恢复1h后检查。状态转换时间不多于1小时 5 cycles of a) -25°C±2°C 0.5hour b) +85°C±2°C 0.5hour	外观 Appearance	无损伤 No Damage
			接触电阻 LLCR	40mΩ MAX
			绝缘电阻 Insulation Resistance	500MΩ MIN
15	振动 Vibration	插合连接器, 串联在一直流电源上, 电流100mA; 并模拟正常工作状态, 振频为10~55Hz、振幅0.35mm; 55~500Hz、加速度50m/s ² , 每一轴线扫频循环次数10次、2小时。 Frequency: 10~55Hz Amplitude: ±0.35mm Frequency: >55~500Hz Acceleration: 50m/s ² Duration: 2 hours in each X,Y,Z axes	外观 Appearance	无损伤 No Damage
			接触电阻 Contact Resistance	40mΩ MAX
			中断 Intermittence	1 μ sec MAX
16	机械寿命 Repeated insertion/ withdrawal	以每分钟插拔10次的速率, 插拔50次。 When mated up to 50 cycles repeatedly by the rate of 10 cycles per minute.	接触电阻 Contact Resistance	40mΩ MAX
17	盐雾 Salt Spray	把先冲后镀的测试样品从试验箱顶悬挂下来, 采用浓度为5%±1(质量百分比)的氯化钠溶液, 连续雾化16小时, 试验后用流动的蒸馏水轻轻洗去表面沉积物。在常温常驻湿条件下恢复1~2小时。 16 hour exposure to a saltspray from the 5%±1 solution.	外观无损伤(五金件应无露出底金属的严重锈蚀; 使用预镀的型材, 其落料面允许有不影响其性能的轻微腐蚀。) Exterior No Damage	

X-ON Electronics

Largest Supplier of Electrical and Electronic Components

Click to view similar products for [Headers & Wire Housings](#) category:

Click to view products by [Boom](#) manufacturer:

Other Similar products are found below :

[95000-104TRLF](#) [10135584-644402LF](#) [DF62W-EP2022PCA](#) [95000-106TRLF](#) [DF62W-2022SCA](#) [DF62W-EP2022PC](#) [2203348](#) [DF62W-2022SC](#) [1084018](#) [1029039](#) [1084017](#) [802-10-012-10-002000](#) [1112640](#) [1112639](#) [891-007-9SS-BST1T](#) [000-34000](#) [0008550134](#) [0009482033](#) [0009507031](#) [57102-F02-18ULF](#) [57102-S06-03LF](#) [57202-S52-04LF](#) [PCN6-15S-2.5E](#) [0039019024](#) [58102-G61-06LF](#) [582553-1](#) [0009485154](#) [0009508121](#) [0022285053](#) [0050291907](#) [018731A](#) [LY20-4P-DT1-P1E-BR](#) [02.125.8002.8](#) [60101931](#) [60598-1 \(Cut Strip\)](#) [M1625-3R/100](#) [61062-3](#) [61082-181009](#) [CSU011177004](#) [636-1427](#) [638009-1](#) [641938-9](#) [641991-4](#) [644168-1](#) [644827-2](#) [647662-1](#) [65039-019ELF](#) [65692-001LF](#) [65781-018](#) [65781-047](#)