



◆ SPECIFICATIONS

Unit:mm

- ◇ Poles: 2~16
- ◇ Applicable wire: AWG#22-#32
- ◇ Voltage rating: 250V DC/AC
- ◇ Current rating: 3.0A
- ◇ Withstand voltage: 1000V AC
- ◇ Working Temperature: -25°C ~ +85°C
- ◇ Insulation resistance: $\geq 1000M\Omega$
- ◇ Contact resistance: $\leq 0.02\Omega$
- ◇ Applicable PC board thickness: 1.6mm

 UL:Recognized No.E309635
 RoHS-specification and
 Halogen-free products

XH-nY

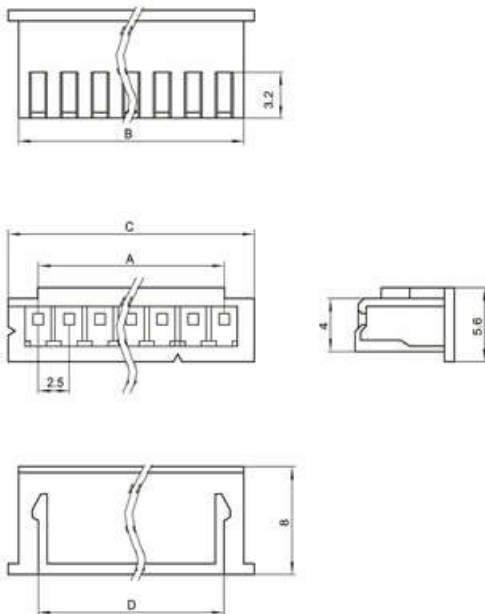

XH-nA

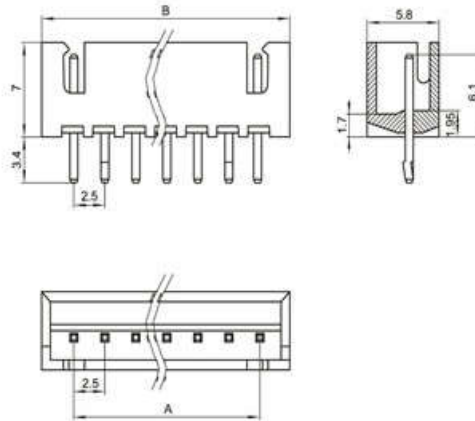

XH-nAW

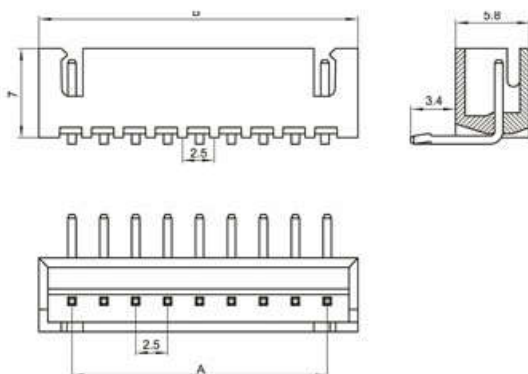

XH-nAWD

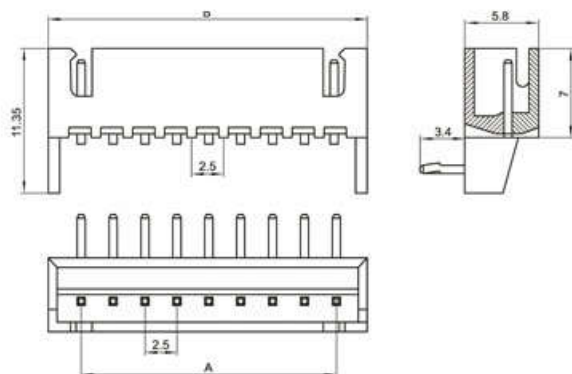

Unit:mm

XH-PT

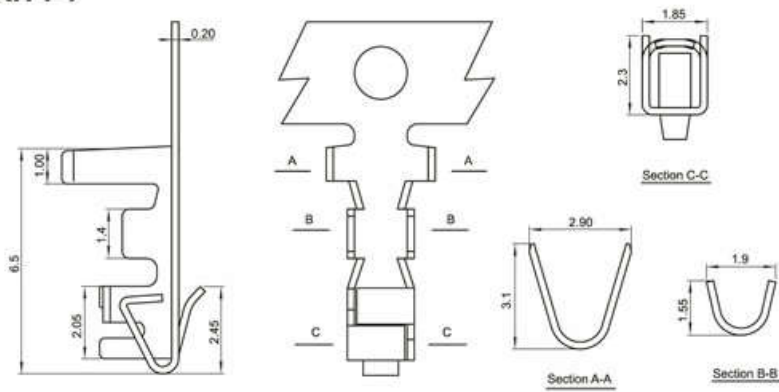

Mounting Measurement

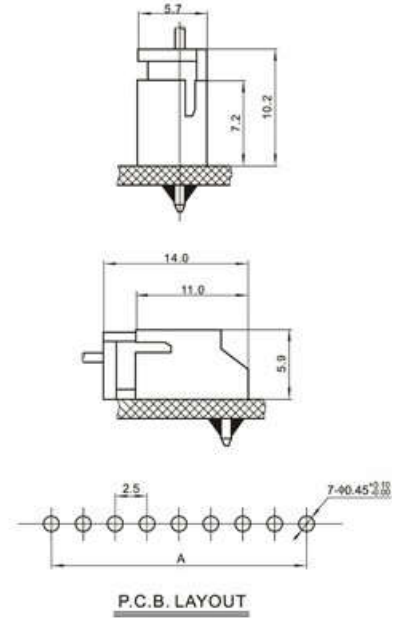

Terminal(XH)

Type	Applicable wires		O.D of wire ins	Material	Finish
	mm ²	AWG#	mm		
BM-XH	0.08-0.3	24-32	1.2-1.9	Phos.bronze	Tin-plated

Poles	Type	Size(mm)			
		A	B	C	D
2	XH-2Y	2.5	5.7	7.5	2.5
3	XH-3Y	5.0	8.2	10.0	5.0
4	XH-4Y	7.5	10.7	12.5	7.5
5	XH-5Y	10.0	13.2	15.0	10.0
6	XH-6Y	12.5	15.7	17.5	12.5
7	XH-7Y	15.0	18.3	20.0	15.0
8	XH-8Y	17.5	20.8	22.5	17.5
9	XH-9Y	20.0	23.3	25.0	20.0
10	XH-10Y	22.5	25.7	27.5	22.5
11	XH-11Y	25.0	28.3	30.0	25.0
12	XH-12Y	27.5	30.7	32.5	27.5
13	XH-13Y	30.0	33.2	35.0	30.0
14	XH-14Y	32.5	35.7	37.5	32.5
15	XH-15Y	35.0	38.3	40.0	35.1
16	XH-16Y	37.5	40.8	42.5	37.6

Poles	Type	Size(mm)	
		A	B
2	XH-2A	2.5	7.5
3	XH-3A	5.0	10.0
4	XH-4A	7.5	12.5
5	XH-5A	10.0	15.0
6	XH-6A	12.5	17.5
7	XH-7A	15.0	20.0
8	XH-8A	17.5	22.5
9	XH-9A	20.0	25.0
10	XH-10A	22.5	27.5
11	XH-11A	25.0	30.0
12	XH-12A	27.5	32.5
13	XH-13A	30.0	35.0
14	XH-14A	32.5	37.5
15	XH-15A	35.0	40.0
16	XH-16A	37.5	42.5

X-ON Electronics

Largest Supplier of Electrical and Electronic Components

Click to view similar products for [Headers & Wire Housings](#) category:

Click to view products by [Boom](#) manufacturer:

Other Similar products are found below :

[95000-104TRLF](#) [10135584-644402LF](#) [DF62W-EP2022PCA](#) [95000-106TRLF](#) [DF62W-2022SCA](#) [DF62W-EP2022PC](#) [2203348](#) [DF62W-2022SC](#) [1084018](#) [1029039](#) [1084017](#) [802-10-012-10-002000](#) [1112640](#) [1112639](#) [891-007-9SS-BST1T](#) [000-34000](#) [0008550134](#) [0009482033](#) [0009507031](#) [57102-F02-18ULF](#) [57102-S06-03LF](#) [57202-S52-04LF](#) [PCN6-15S-2.5E](#) [0039019024](#) [58102-G61-06LF](#) [582553-1](#) [0009485154](#) [0009508121](#) [0022285053](#) [0050291907](#) [018731A](#) [LY20-4P-DT1-P1E-BR](#) [02.125.8002.8](#) [60101931](#) [60598-1 \(Cut Strip\)](#) [M1625-3R/100](#) [61062-3](#) [61082-181009](#) [CSU011177004](#) [636-1427](#) [638009-1](#) [641938-9](#) [641991-4](#) [644168-1](#) [644827-2](#) [647662-1](#) [65039-019ELF](#) [65692-001LF](#) [65781-018](#) [65781-047](#)