

FPC连接器 抽拉式下接 1.0mm间距 26Pin

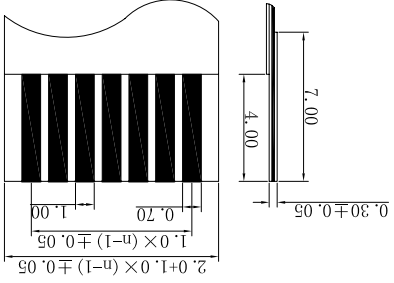

主要技术特性:
 间距: 1.0 mm
 板数: 4~32
 额定电压: 50V AC, DC
 额定电流: 0.5A
 温度范围: -25°C~+85°C
 耐压: 200V/min
 接触电阻: ≤0.04 Ω
 绝缘电阻: ≥500M Ω

材料:
 壳体: LCP UL94V-0 本色
 锁扣: LCP UL94V-0 黑色
 接触针: 磷青铜(镀锡)
 焊片: 磷青铜(镀锡)

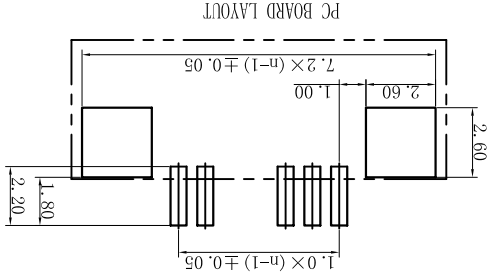
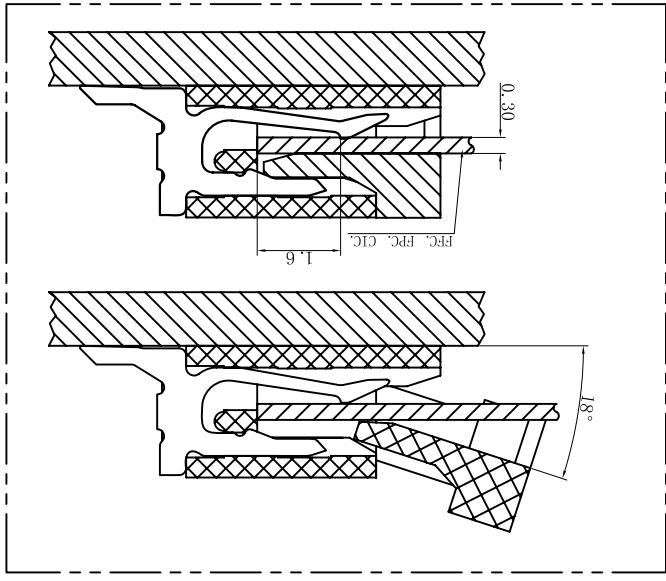
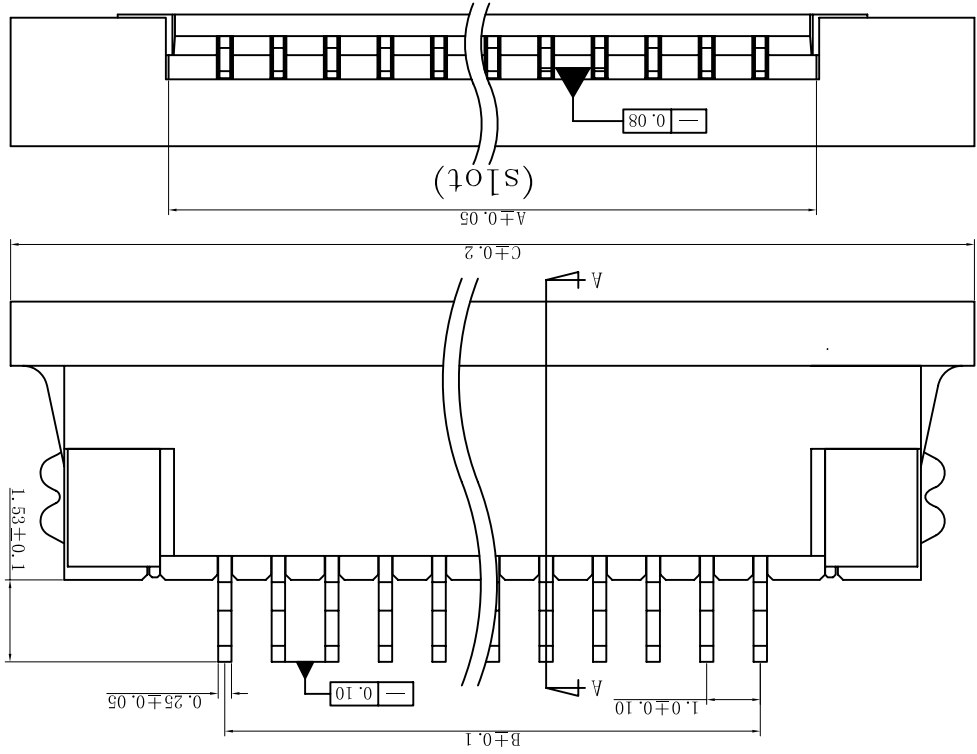
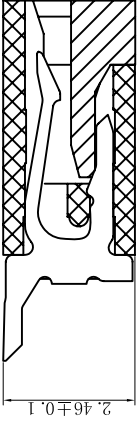
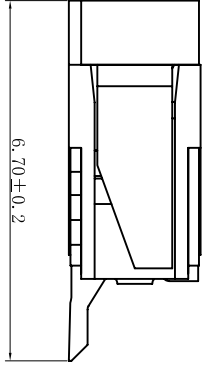

Dimensions		NO. of Contacts (n)	
A	B	A	B
4	5.1	3.0	11.0
5	6.1	4.0	12.0
6	7.1	5.0	13.0
7	8.1	6.0	14.0
8	9.1	7.0	15.0
9	10.1	8.0	16.0
10	11.1	9.0	17.0
11	12.1	10.0	18.0
12	13.1	11.0	19.0
13	14.1	12.0	20.0
14	15.1	13.0	21.0
15	16.1	14.0	22.0
16	17.1	15.0	23.0
17	18.1	16.0	24.0
18	19.1	17.0	25.0
19	20.1	18.0	26.0
20	21.1	19.0	27.0
21	22.1	20.0	28.0
22	23.1	21.0	29.0
23	24.1	22.0	30.0
24	25.1	23.0	31.0
25	26.1	24.0	32.0
26	27.1	25.0	33.0
27	28.1	26.0	34.0
28	29.1	27.0	35.0
29	30.1	28.0	36.0
30	31.1	29.0	37.0
31	32.1	30.0	38.0
32	33.1	31.0	39.0

UNITS: mm	NAME: FPCL 0拉拔式半包下接	GENERAL TOLERANCE	PART NO.(料号)
X. ±5°	0.X±0.3	APPD:	
X.1±2°	0.XX±0.2	CHKD:	
XX. ±1°	0.XXX±0.1	DR:	
XXX. ±0.5°			

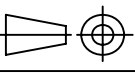

SCALE	1:1	1 OF 1	A
SHEET			REV

X-ON Electronics

Largest Supplier of Electrical and Electronic Components

Click to view similar products for [FFC & FPC Connectors](#) category:

Click to view products by [Boom](#) manufacturer:

Other Similar products are found below :

[HFW11R-1STE1H1LF](#) [FH29B-100S-0.2SHW\(99\)](#) [FA5S008HP1](#) [FH29B-120S-0.2SHW\(99\)](#) [FH29B-80S-0.2SHW\(99\)](#) [FHS-16](#) [FPH-2022G](#)
[52610-1075](#) [52610-1275](#) [52610-1934](#) [XF3M\(1\)-1415-1B-R100](#) [501864-3091-TR225](#) [0525594033](#) [086210010340800](#) [086222026001800](#)
[52271-2869-CUT-TAPE](#) [62674-201121DLF](#) [62684-36210E9ALF](#) [52610-1675](#) [52746-1671-TR250](#) [10051922-2810EHLF](#) [6-520415-9](#)
[BD021-09A-A1-0350-0200-0550-LD](#) [SFV6R-1STE9HLF](#) [XF3M-2915-1B-R100](#) [1658549-1](#) [62674-221121ALF](#) [46214008010800](#)
[046298003000883](#) [151660622](#) [842-816-2630-035](#) [AYF530665TA](#) [AYF351525](#) [046296011930846+](#) [AYF352325A](#) [046254020000800+](#)
[FH19C-13S-0.5SH\(99\)](#) [FH39J-51S-0.3SHW\(99\)](#) [AYF355125A](#) [AYF530365TA](#) [FH29B-44S-0.2SHW\(99\)](#) [SFW5R-2STAE9LF](#) [AYF351125A](#)
[AYF350725A](#) [62684-502100AHLF](#) [FH39-61S-0.3SHW\(99\)](#) [AYF414035A](#) [10064555-172520HLF](#) [AYF212335A](#) [504754-2500](#)