

# 规格确认栏

SPECIFICATION FOR APPROVAL

客户(CUSTOMER): \_\_\_\_\_

品名(ARTICLE): \_\_\_\_\_

客户型号(YOUR MODEL No.): PH-D SERIES

客户确认 (CUSTOMER APPROVED BY) :

	经理		主管		经办	
	签字	日期	签字	日期	签字	日期
完全确认						
条件确认						
不予确认						

意见与建议 (OPINION AND RECOMMEND) :

<b>PRODUCT SPECIFICATION</b>	语言 LANGUAGE
	中文 CHINESE
	英语 ENGLISH

1. 适用范围 SCOPE

本规格包含 2.0mm 线对板连接器系列

This specification covers the 2.0mm PITCH WIRE TO BOARD CONNECTOR series.

2. 产品名称和型号 PRODUCT NAME AND PART NUMBER

产品名称 Product Name	产品型号 Part Number	包装数量 packaging
端子 Terminal (AWG #24-30)	PH-D-PT	
胶壳 Housing	PH-D-2*Y/HK	
针座组装 Wafer Assembly (R/A)	无铅 LEAD FREE	PH-D-2*A
针座包装 Wafer Assembly (R/A)	无铅 LEAD FREE	塑袋包装 ( plastic Package)
针座包装 Wafer Assembly (R/A)	无铅 LEAD FREE	塑袋包装 ( plastic Pckage)

参照图片 Refer to the drawing

3. 等级和适用电线 RATINGS AND APPLICABLE WIRES

项目 Item	标准 Standard	
最大额定电 Rated Voltage (MAX.)	250V	
最大额定电流和适用电线 Rated Current (MAX.) and Applicable wires	AWG. #24	2.0 A
	AWG. #32	2.0 A
环境温度范围 Ambient Temperature Range	-25°C ~ +85°C*1	
	Ø 1.0mm MAX. Insulation O.D	

REV.	B														
SHEET	1-9														

只根据 PC 修订 REVISE ON PC ONLY		标题 TITLE: 2.0 间距线对板连接器产品规格书 2.0mm PITCH WIRE TO BOARD SMT CONNECTOR													
<b>B</b>	见 1/9 页 SEE SHEET 1 OF 9	本文件所含的信息属 BOOMELE 公司所有, 没有书面同意其他人不得使用 THIS DOCUMENT CONTAINS INFORMATION THAT IS PROPRIETARY TO BOOMELE INC. AND SHOULD NOT BE USED WITHOUT WRITTEN PERMISSION													
	版本 REV.	描述 DESCRIPTION													
设计控制 DESIGN CONTROL CHENGUANGQIAO SUNDIXIONG	STATUS	编制 WRITTEN BY: WUZHENGFANG	审核 CHECKED BY: LIMINGMAO	批准 APPROVED BY: LIUXUPING	日期 DATE: YR/MO/DAY 2008/07/25										

文件编号 DOCUMENT NUMBER		文件名称 FILE NAME	页数 SHEET 1 OF 9
----------------------	--	----------------	--------------------

<b>PRODUCT SPECIFICATION</b>	语言 LANGUAGE
	中文 CHINESE
	英语 ENGLISH

\*1.包括端子温度的上升  
Including terminal temperature rise.

只根据 PC 修订 REVISE ON PC ONLY		标题 TITLE: 2.0 间距线对板连接器产品规格书 2.0mm PITCH WIRE TO BOARD SMT CONNECTOR	
<b>B</b>	见 1/9 页 SEE SHEET 1 OF 9	本文件所含的信息属 BOOMELE 公司所有，没有书面同意其他人不得使用 THIS DOCUMENT CONTAINS INFORMATION THAT IS PROPRIETARY TO BOOMELE INC. AND SHOULD NOT BE USED WITHOUT WRITTEN PERMISSION	
版本 REV.	描述 DESCRIPTION		
文件编号 DOCUMENT NUMBER		文件名称 FILE NAME	页数 SHEET 2 OF 9

<b>PRODUCT SPECIFICATION</b>	语言 LANGUAGE
	中文 CHINESE
	英语 ENGLISH

4. 性能  
PERFORMANCE

4-1 . 电性能  
ELECTRICAL PERFORMANCE

项目 Item		测试条件 Test condition	规格要求 Requirement
4-1-1	接触电阻 Contact Resistance	插配阴阳连接器后，用小功率电路进行测试。最大电压 10mV ， 电流 20mA Mate connectors, measure by dry circuit,10mV MAX., 20mA. (JIS C5402 5.4)	最大值 < 10 毫欧 20 milliohm MAX.
4-1-2	绝缘电阻 Insulation Resistance	(插配阴阳连接器后,) 在相邻端子或地线和端子之间用 800V 的小功率电路进行测试 (JIS C5402 5.2/MIL-STD-202 测试法 302)Apply 800V DC between adjacent terminals or terminal and ground .(JIS C54025.2/MIL-STD-202 Method 302)	最小值 100 兆欧姆 100 Megohm MIN.
4-1-3	耐压强度/绝缘强度 Dielectric Strength	用 800V 电压在相邻端子或地线和端子之间进行测试 1 分钟 Apply 800V AC(rms) between adjacent terminals or terminal and ground for 1 minute. (JIS C5402 5.1/MIL-STD-202 Method 301) (JIS C5402 5.1/MIL-STD-202 测试法 301)	无击穿和飞弧现象 No Breakdown
4-1-4	压线部位接触电阻 Contact Resistance on Crimped Portion	10mV MAX., 20mA. 用适合的电线将端子压线，然后用小功率电路进行电阻测试。最大电压 20mV， 电流 10mA Crimp the applicable wire to the terminal, and measure contact resistance by dry circuit,	最大值 5 毫欧 5 milliohm MAX.

只根据 PC 修订 REVISE ON PC ONLY		标题 TITLE: 2.0 间距线对板连接器产品规格书 2.0mm PITCH WIRE TO BOARD SMT CONNECTOR	
<b>B</b>	见 1/9 页 SEE SHEET 1 OF 9	本文件所含的信息属 BOOMELE 公司所有，没有书面同意其他人不得使用 THIS DOCUMENT CONTAINS INFORMATION THAT IS PROPRIETARY TO BOOMELE INC. AND SHOULD NOT BE USED WITHOUT WRITTEN PERMISSION	
	版本 REV.	描述 DESCRIPTION	
文件编号 DOCUMENT NUMBER		文件名称 FILE NAME	页数 SHEET 3 OF 9

<b>PRODUCT SPECIFICATION</b>	语言 LANGUAGE
	中文 CHINESE
	英语 ENGLISH

4-2 . 机械性能 MECHANICAL PERFORMANCE

项目 Item		测试条件 Test condition	规格要求 Requirement
4-2-1	插入力和拔出力 Insertion and Withdrawal Force	以每分钟 25+3mm 的速度拔出，插入连接器 Insert and withdraw connectors at the speed rate of 25+ 3mm/minute.	7 参考第七段 Refer to paragraph
4-2-2	压线强度 Crimping Strength	固定压好线的端子，以每分钟 25+3mm 的速度沿 着轴线拔出线 Fix the crimped terminal, apply axial pull out force on the wire at the speed rate of 25+ 3mm/minute.	AWG. #24 9.8 N 1.0kgf MIN.
			AWG. #32 4.9 N 0.5kgf MIN.
4-2-3	端子插入力 Terminal Insertion Force	将已经压好线对端子插入胶壳 Insert the crimped terminal into the housing	4.9 N 0.5kgf MAX.
4-2-4	端子和胶壳的固 定力 Terminal/ Housing Retention Force	以每分钟 25+3mm 的速度，沿着轴线将装在胶壳 里的端子拔出 Apply axial pull out force to the terminal assembled in the housing at the speed rate of 25 +3mm/minute.	4.9 N 0.5kgf MIN.
4-2-5	针对固定力 Pin Retention Force	以每分钟 25+3mm 的速度，沿着轴线将针拔出 Apply axial push force at the speed rate of 25+ 3mm/minute.	4.9 N 0.5kgf MIN.

只根据 PC 修订 REVISE ON PC ONLY		标题 TITLE: 2.0 间距线对板连接器产品规格书 2.0mm PITCH WIRE TO BOARD SMT CONNECTOR	
<b>B</b>	见 1/9 页 SEE SHEET 1 OF 9	本文件所含的信息属 BOOMELE 公司所有，没有书面同意其他人不得使用 THIS DOCUMENT CONTAINS INFORMATION THAT IS PROPRIETARY TO BOOMELE INC. AND SHOULD NOT BE USED WITHOUT WRITTEN PERMISSION	
		版本 REV.	描述 DESCRIPTION
文件编号 DOCUMENT NUMBER		文件名称 FILE NAME	页数 SHEET 4 OF 9

<b>PRODUCT SPECIFICATION</b>	语言 LANGUAGE
	中文 CHINESE
	英语 ENGLISH

4-2 . 机械性能 MECHANICAL PERFORMANCE

项目 Item		测试条件 Test condition	规格要求 Requirement	
4-3-1	机械寿命 Repeated Insertion/ Withdrawal	以每分钟插拔 10 次的速度插拔 30 次。 When mated up to 30 cycles repeatedly by the rate of 10 cycles per minute.	接触电阻 Contact Resistance	最大 40 毫欧 40 milliohm MAX.
4-3-2	温度上升 Temperature Rise	通以最大额定电流 (UL 498) Carrying rated current load. (UL 498)	温度上升 Temperature Rise	最大 30 摄氏度 30 MAX.
4-3-3	振动 Vibration	Amplitude 振幅 1.5mm P-P SWEEP TIME: 扫描时间: 10-55-10 Hz in 1 minute 每分钟 10-55-10 赫兹 Duration: 持续时间: 2 hours in each x.y.z. axes X.Y.Z 三轴各 2 小时 (MIL-STD-202 Method 201) (MIL-STD-202 测试法 201)	外观 Appearance	无损伤 No Damage
			接触电阻 Contact Resistance	最大 40 毫欧 40 milliohm MAX.
			中断 Discontinuity	最大 1 微秒 1.0 microsecond MAX.
4-3-4	耐冲击性 Shock	490m/s2 {50G}, 3 strokes in each X.Y.Z. axes. (JIS C60068-2-27/MIL-STD-202 Method 213) 490m/s2 {50G}, X.Y.Z 轴各 3 击 (JIS C60068-2-27/MIL-STD-202 测试法 213)	外观 Appearance	无损伤 No Damage
			接触电阻 Contact Resistance	最大 40 毫欧 40 milliohm MAX.
			中断 Discontinuity	最大 1 微秒 1.0 microsecond MAX.
4-3-5	耐热性 Heat Resistance	85 2 96 hours (JIS C60068-2-2/MIL-STD-202 Method 108)在 83 到 87 摄氏度的环境中放置 (JIS C60068-2-2/MIL-STD-202 测试法 108)	外观 Appearance	无损伤 No Damage
			接触电阻 Contact Resistance	最大 40 毫欧 40 milliohm MAX.

只根据 PC 修订 REVISE ON PC ONLY		标题 TITLE: 2.0 间距线对板连接器产品规格书 2.0mm PITCH WIRE TO BOARD SMT CONNECTOR		
<b>B</b>	见 1/9 页 SEE SHEET 1 OF 9	本文件所含的信息属 BOOMELE 公司所有, 没有书面同意其他人不得使用 THIS DOCUMENT CONTAINS INFORMATION THAT IS PROPRIETARY TO BOOMELE INC. AND SHOULD NOT BE USED WITHOUT WRITTEN PERMISSION		
		版本 REV.	描述 DESCRIPTION	
文件编号 DOCUMENT NUMBER			文件名称 FILE NAME	页数 SHEET 5 OF 9

<b>PRODUCT SPECIFICATION</b>	语言 LANGUAGE
	中文 CHINESE
	英语 ENGLISH

项目 Item		测试条件 Test condition	规格要求 Requirement	
4-3-6	耐寒性 Cold Resistance	在零下 37 到零下 43 摄氏度的环境下放置 96 小时(JIS C60068-2-1)	外观 Appearance	无损伤 No Damage
			接触电阻 Contact Resistance	最大 40 毫欧 40 milliohm MAX.
4-3-7	耐 湿 性 Humidity	温度 58-62 摄氏度 Temperature 58-62 相对湿度 90-95% Relative Humidity 90-95% 持续时间: 96 小时 Duration 96 hours (JIS C60068-2-3/MIL-STD-202 Method 103)(JIS C60068-2-3/MIL-STD-202 测试法 103)	外观 Appearance	无损伤 No Damage
			接触电阻 Contact Resistance	最大 40 毫欧 40 milliohm MAX.
			耐压强度 Dielectric Strength	满足 4-1-3 Must meet 4-1-3
			绝缘电阻 Insulation Resistance	最小 10 兆欧姆 10MegohmMIN.
4-3-8	温 度 循 环 Temperature Cycling	5 cycles of : a) - 55 30minute b) +105 30minute (JIS C0025) a)在零下 55 摄氏度放置 30 分钟 b) 在岭上 105 摄氏度放置 30 分钟, 5 个这样的循环(JIS C0025)	外观 Appearance	无损伤 No Damage
			接触电阻 Contact Resistance	最大 40 毫欧 40 milliohm MAX.
4-3-9	盐 雾 Salt Spray	48 4 hours exposure to a salt spray from the 5 1% solution at 35 2 . (JIS C5028/MIL-STD-202 Method 101) 在 33-35 摄氏度的环境中, 采用浓度为 4-6%的氯化钠溶液, 连续雾化 44-52 小时, 然后再水中洗净, 在室内干燥	外观 Appearance	无损伤 No Damage
			接触电阻 Contact Resistance	最大 40 毫欧 40 milliohm MAX.

只根据 PC 修订 REVISE ON PC ONLY		标题 TITLE: 2.0 间距线对板连接器产品规格书 2.0mm PITCH WIRE TO BOARD SMT CONNECTOR		
<b>B</b>	见 1/9 页 SEE SHEET 1 OF 9	本文件所含的信息属 BOOMELE 公司所有, 没有书面同意其他人不得使用 THIS DOCUMENT CONTAINS INFORMATION THAT IS PROPRIETARY TO BOOMELE INC. AND SHOULD NOT BE USED WITHOUT WRITTEN PERMISSION		
		版本 REV.	描述 DESCRIPTION	
文件编号 DOCUMENT NUMBER			文件名称 FILE NAME	页数 SHEET 6 OF 9
EN-37-1 (019)				

<b>PRODUCT SPECIFICATION</b>	语言 LANGUAGE
	中文 CHINESE
	英语 ENGLISH

4-3-10	亚硫酸气体 SO2 Gas	在 38-42 摄氏度的温度下在 45-5ppm 亚硫酸气体中放置 24 小时 24 hours expose to 50 5ppm . SO2 gas at 40 2 .	外观 Appearance	无损伤 No Damage
			接触电阻 Contact Resistance	最大 40 毫欧 40 milliohm MAX.
4-3-11	氨气 NH3 Gas	在从 28%的氨气溶液中蒸发出来的氨气中暴露 40 分钟 40 minutes exposure to NH3 gas evaporating from 28% Ammonia solution.	外观 Appearance	无损伤 No Damage
			接触电阻 Contact Resistance	最大 40 毫欧 40 milliohm MAX.
4-3-12	可焊性 Solderability	焊接时间: 2-3 秒, 焊接温度 242-248 摄氏度, 从端子顶到接头顶 0.5mm Soldering Time 2 3 sec. Solder Temperature 245 3 0.5mm from terminal tip and fitting nail tip.	焊锡附着性 Solder Wetting	95%浸泡的地方没有间点和小孔 95 of immersed area must show no voids, pin holes
4-3-13	耐焊热性 Resistance To Soldering Heat	软熔发亮处理, 重复第六段 When reflowing Repeat paragraph 6.	无损伤 No Damage	
		Soldering iron method 焊铁方法 Soldering time : 3 1 sec. 焊接时间: 2-4 秒 Solder temperature 370 400 焊接温度 370-400 摄氏度 0.5mm from terminal tip and fitting nail tip 从端子顶到接头顶 0.5mm		
( ) : 参考规格 REFERENCE				

只根据 PC 修订 REVISE ON PC ONLY		标题 TITLE: 2.0 间距线对板连接器产品规格书 2.0mm PITCH WIRE TO BOARD SMT CONNECTOR		
<b>B</b>	见 1/9 页 SEE SHEET 1 OF 9	本文件所含的信息属 BOOMELE 公司所有, 没有书面同意其他人不得使用 THIS DOCUMENT CONTAINS INFORMATION THAT IS PROPRIETARY TO BOOMELE INC. AND SHOULD NOT BE USED WITHOUT WRITTEN PERMISSION		
		版本 REV.	描述 DESCRIPTION	
文件编号 DOCUMENT NUMBER		文件名称 FILE NAME	页数 SHEET 7 OF 9	
EN-37-1 (019)				



<b>PRODUCT SPECIFICATION</b>	语言 LANGUAGE
	中文 CHINESE
	英语 ENGLISH

Standard

- 5. 产品形状，尺寸和材料 PRODUCT SHAPE, DIMENSIONS AND MATERIALS  
参考图纸 Refer to the drawing
- 6. 红外线回流（软熔）条件 INFRARED REFLOW CONDITION

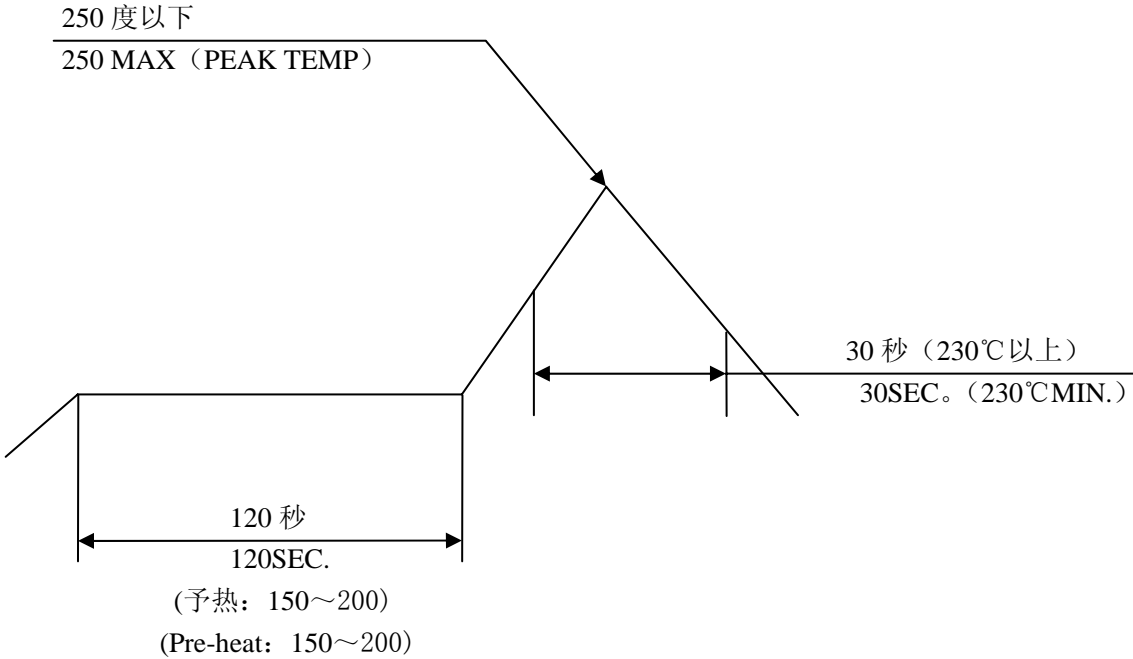

注 明：请先根据你自己的设备检查一下软熔焊剂条件，因为该条件是随着焊接设备，P.C.板等的不同而不同的。  
NOTE : Please check the reflow soldering condition by your own devices beforehand. Because the condition changes by the soldering devices, P.C.Boards, and so on.

只根据 PC 修订 REVISE ON PC ONLY		标题 TITLE: 2.0 间距线对板连接器产品规格书 2.0mm PITCH WIRE TO BOARD SMT CONNECTOR	
<b>B</b>	见 1/9 页 SEE SHEET 1 OF 9	本文件所含的信息属 BOOMELE 公司所有，没有书面同意其他人不得使用 THIS DOCUMENT CONTAINS INFORMATION THAT IS PROPRIETARY TO BOOMELE INAND SHOULD NOT BE USED WITHOUT WRITTEN PERMISSION	
		文件名称 FILE NAME	页数 SHEET 8 OF 9
版本 REV.		描述 DESCRIPTION	
文件编号 DOCUMENT NUMBER			

<b>PRODUCT SPECIFICATION</b>	语言 LANGUAGE
	中文 CHINESE
	英语 ENGLISH

7. 插入/拔出力 INSERTION / WITHDRAWAL FORCE

单位 (N) Unit (N)		单孔 monotrematous				
		试样一	试样二	试样三	试样四	试样五
胶壳与针座 housing and wafer	插入力 Insertion force	1 5N	2 5N	3 5.5N	4 5.5N	5 5N
	拔出力 Withdrawal force	1 6N	2 6N	3 6N	4 6N	5 6N
胶壳与端子 housing and terminal	插入力 Insertion force	1 0.25N	2 0.25N	3 0.25N	4 0.25 N	5 0.25N
	拔出力 Withdrawal force	1 15.2N	2 15N	3 15N	4 15 N	5 15N
带叶胶壳与端子 Hootype housing and terminal	插入力 Insertion force	1 0.25N	2 0.25N	3 0.25N	4 0.25 N	5 0.25N
	拔出力 Withdrawal force	1 15.2N	2 15N	3 15N	4 15 N	5 15N

注明：胶壳与针座（housing and wafer）  
插入力与拔出力为压线后端子与胶壳、针座相配套组装后测试所得的值

只根据 PC 修订 REVISE ON PC ONLY		标题 TITLE: 2.0 间距线对板连接器产品规格书 2.0mm PITCH WIRE TO BOARD SMT CONNECTOR		
<b>B</b>	见 1/9 页 SEE SHEET 1 OF 9	本文件所含的信息属 BOOMELE 公司所有，没有书面同意其他人不得使用 THIS DOCUMENT CONTAINS INFORMATION THAT IS PROPRIETARY TO BOOMELE INC. AND SHOULD NOT BE USED WITHOUT WRITTEN PERMISSION		
		版本 REV.	描述 DESCRIPTION	
文件编号 DOCUMENT NUMBER		文件名称 FILE NAME	页数 SHEET 9 OF 9	
EN-37-1(019)				

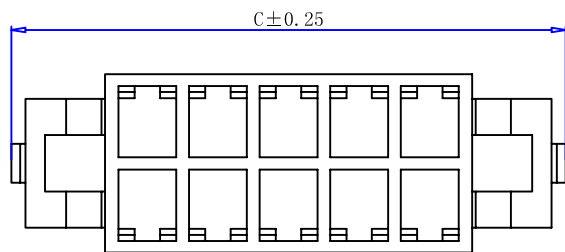
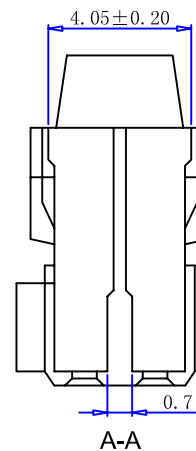
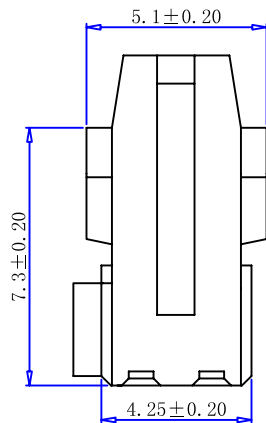
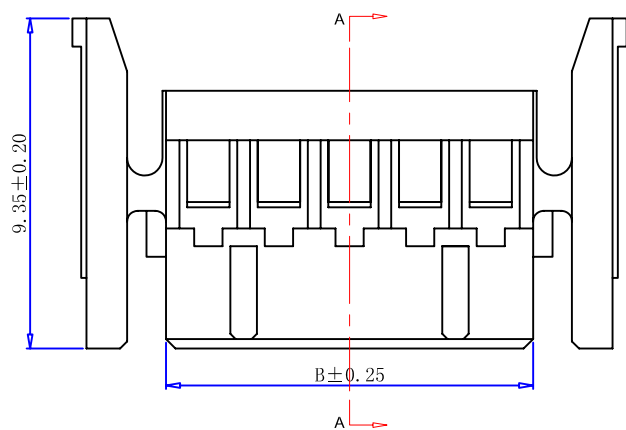
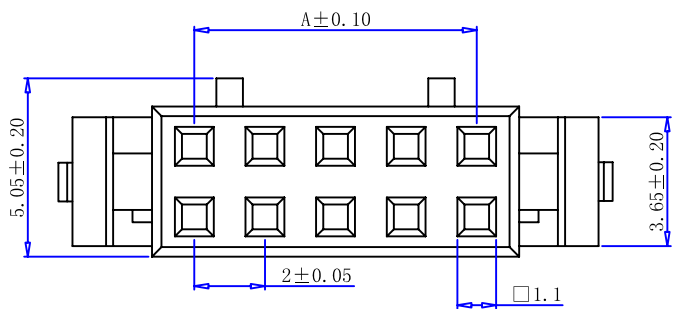

Poles	PART NO	A	B	C
04	PH-2×2	2.00	4.40	9.70
06	PH-2×3	4.00	6.40	11.70
08	PH-2×4	6.00	8.40	13.70
10	PH-2×5	8.00	10.40	15.70
12	PH-2×6	10.00	12.40	17.70
14	PH-2×7	12.00	14.40	19.70
16	PH-2×8	14.00	16.40	21.70
18	PH-2×9	16.00	18.40	23.70
20	PH-2×10	18.00	20.40	25.70
22	PH-2×11	20.00	22.40	27.70
24	PH-2×12	22.00	24.40	29.70
26	PH-2×13	24.00	26.40	31.70
28	PH-2×14	26.00	28.40	33.70
30	PH-2×15	28.00	30.40	35.70
32	PH-2×16	30.00	32.40	37.70
34	PH-2×17	32.00	34.40	39.70
36	PH-2×18	34.00	36.40	41.70
38	PH-2×19	36.00	38.40	43.70
40	PH-2×20	38.00	40.40	45.70

UNIT: MM 	TYPE: <b>CONNECTOR</b>	MODEL NO: PH-D-2×nY-HK	日期 DATE YR/MO/DAY 08.7.25	页次1 OF 1 PAGE1 OF 1
设计控制 DESIGNER BY CHENGUANGQIAO	文件编号 DOCUMENT NUMBER QJ/BM-05-PHD-052	未注公差 TOLERANCE ±0.15	角度公差 ANGLES ±1.5°	比例 SCALE FIT
绘制 DRAFTSMAN BY WUZHENG FANG	审核 CHECKED BY LIMINGMAO	供应商 COME OUT WITH BOOMELE	版本 VER 1.0	
批准 APPROVED BY LIUXUPING				

1 2 3 4 5 6

A

B

C

D

E

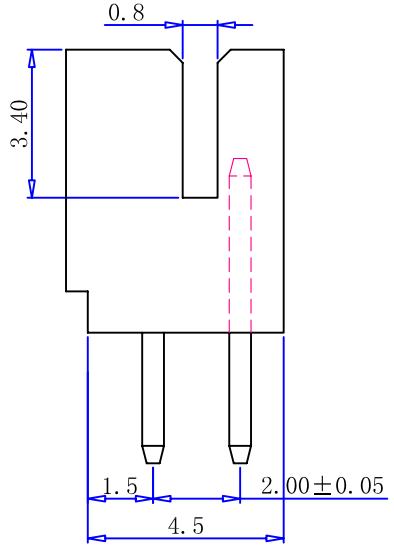
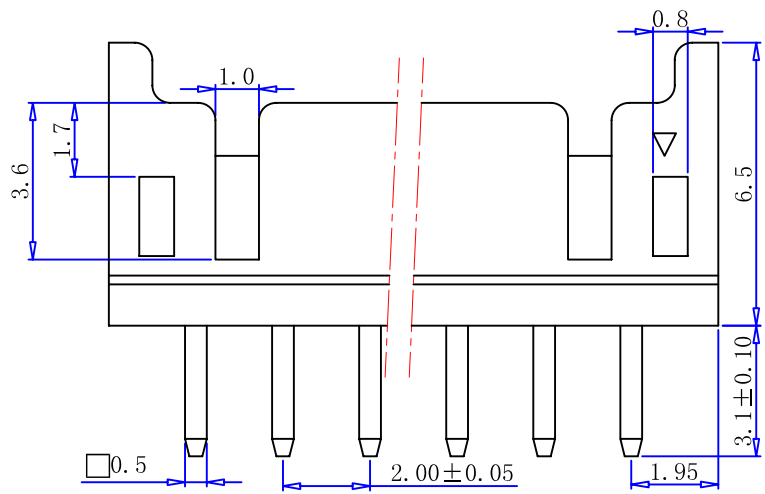
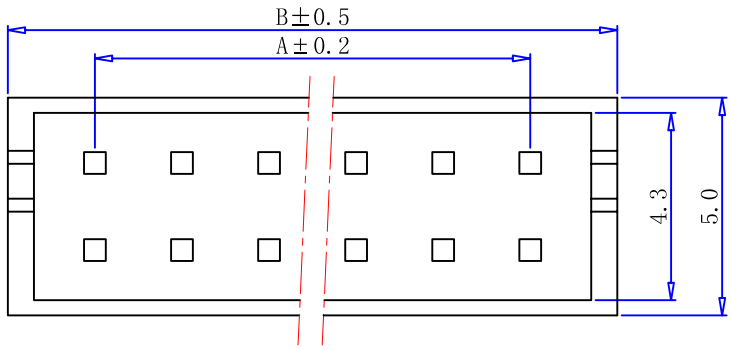

一般公差: X.X 0.25  
 X.XX 0.15  
 X.XXX 0.05

版次	日期	变更内容	变更单号	变更者
1.0		原始版本		

Poles	PART NO	A	B
08	PH-2×4	6.00	9.90
10	PH-2×5	8.00	11.90
12	PH-2×6	10.00	13.90
14	PH-2×7	12.00	15.90
16	PH-2×8	14.00	17.90
18	PH-2×9	16.00	19.90
20	PH-2×10	18.00	21.90
22	PH-2×11	20.00	23.90
24	PH-2×12	22.00	25.90
26	PH-2×13	24.00	27.90
28	PH-2×14	26.00	29.90
30	PH-2×15	28.00	31.90
32	PH-2×16	30.00	33.90
34	PH-2×17	32.00	35.90
36	PH-2×18	34.00	37.90
38	PH-2×19	36.00	39.90
40	PH-2×20	38.00	41.90

A

B

C

D

E

1 2 3 4 5 6

			PHDouble-A		
未注公差	尺寸公差: ±0.10mm	绘制		图号	
	角度公差: ±1°	审查		比例	FIT
		核准		单位	mm
		供应商	BOOM	页次	1 of 1

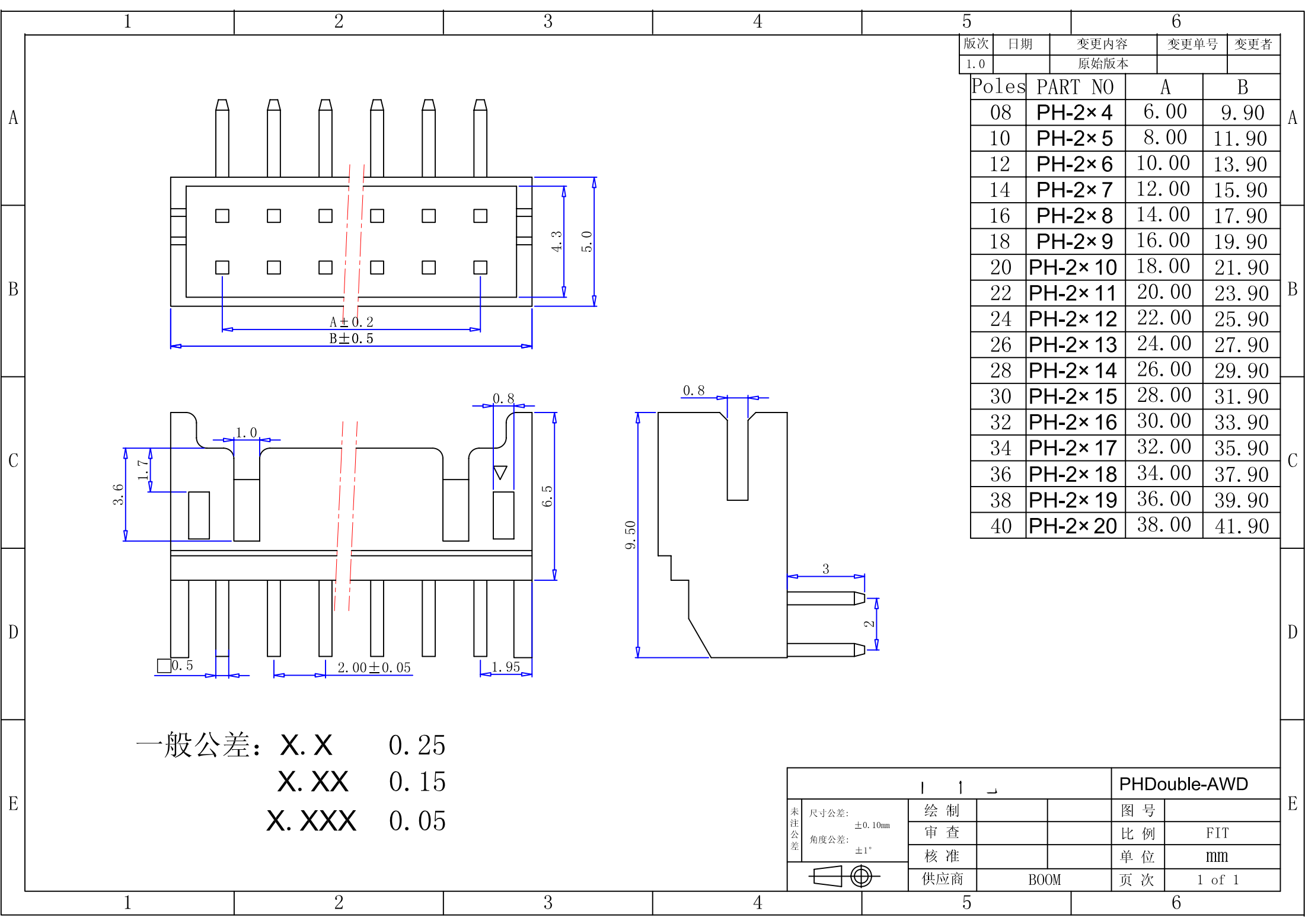

版次	日期	变更内容	变更单号	变更者
1.0		原始版本		

Poles	PART NO	A	B
08	PH-2×4	6.00	9.90
10	PH-2×5	8.00	11.90
12	PH-2×6	10.00	13.90
14	PH-2×7	12.00	15.90
16	PH-2×8	14.00	17.90
18	PH-2×9	16.00	19.90
20	PH-2×10	18.00	21.90
22	PH-2×11	20.00	23.90
24	PH-2×12	22.00	25.90
26	PH-2×13	24.00	27.90
28	PH-2×14	26.00	29.90
30	PH-2×15	28.00	31.90
32	PH-2×16	30.00	33.90
34	PH-2×17	32.00	35.90
36	PH-2×18	34.00	37.90
38	PH-2×19	36.00	39.90
40	PH-2×20	38.00	41.90

一般公差: X.X 0.25  
 X.XX 0.15  
 X.XXX 0.05

1 1 1			PHDouble-AWD	
未注公差	尺寸公差:	绘制	图号	
	±0.10mm	审查	比例	FIT
	角度公差:	核准	单位	mm
	±1°	供应商	页次	1 of 1
		BOOM		

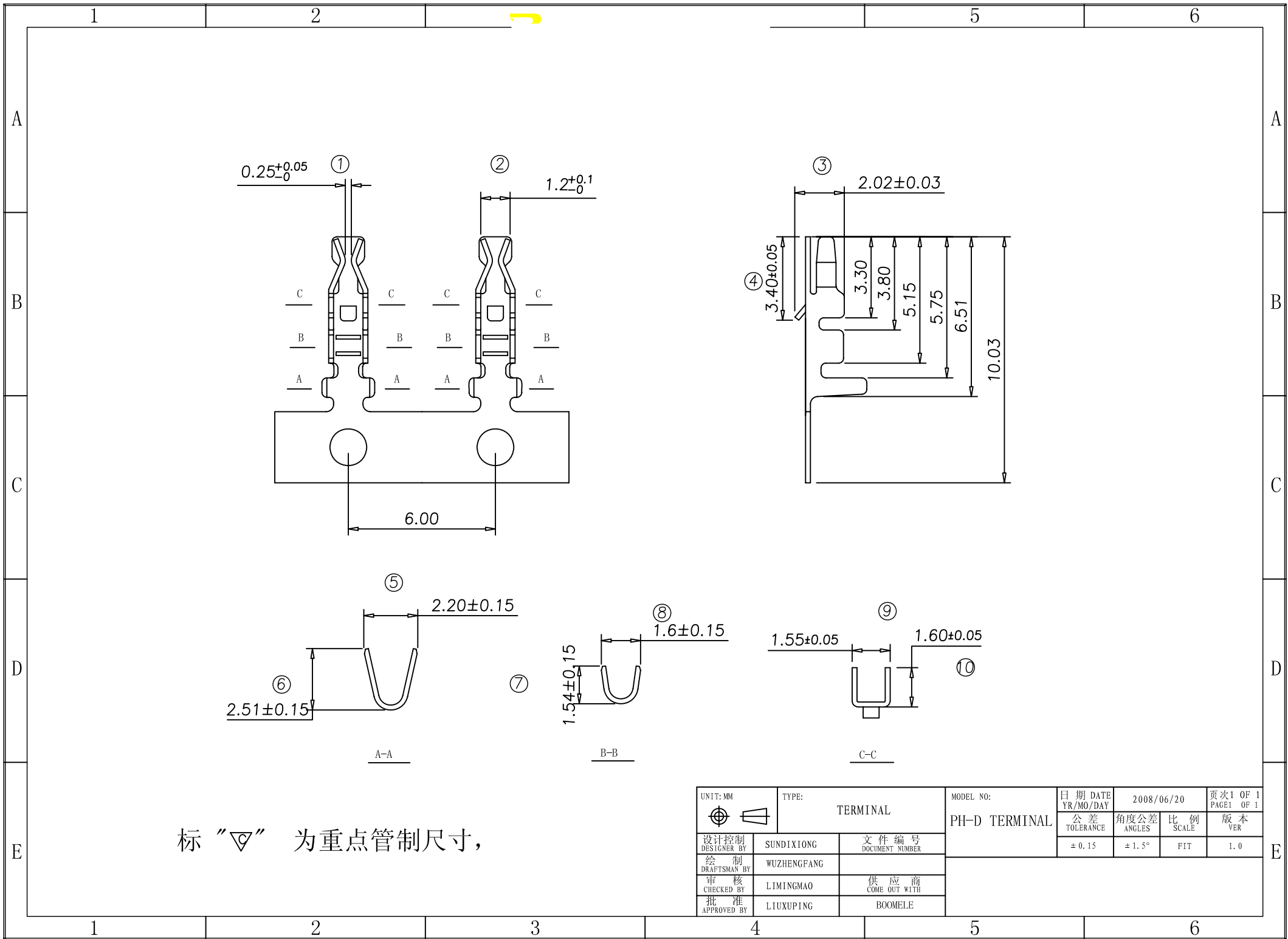

标“▽”为重点管制尺寸，

UNIT: MM 	TYPE: TERMINAL	MODEL NO: PH-D TERMINAL	日期 DATE YR/MO/DAY 2008/06/20	页次 1 OF 1 PAGE 1 OF 1
设计控制 DESIGNER BY SUNDIXIONG	文件编号 DOCUMENT NUMBER	公差 TOLERANCE ± 0.15	角度公差 ANGLES ± 1.5°	比例 SCALE FIT
绘制 DRAFTSMAN BY WUZHENG FANG	供应商 COME OUT WITH	版本 VER 1.0		
审核 CHECKED BY LIMINGMAO	批准 APPROVED BY LIUXUPING			
		BOOMELE		

# BOOMELE

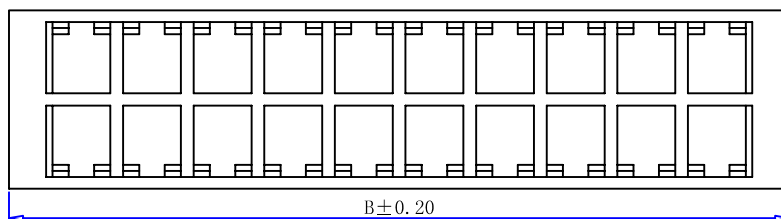
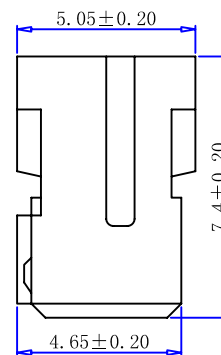
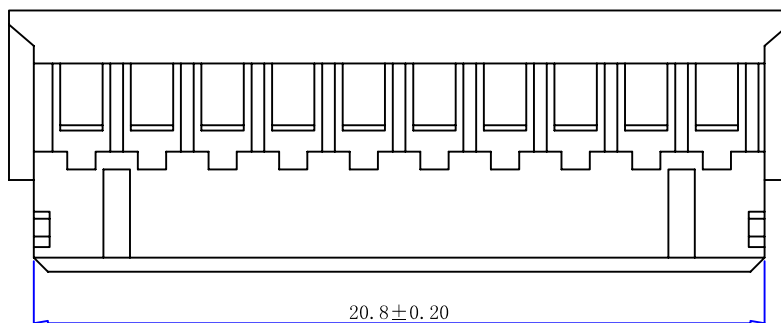
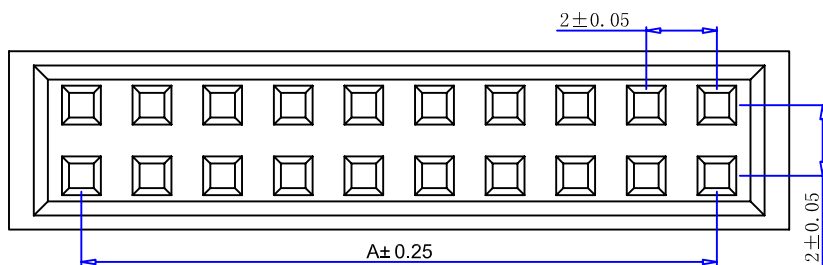

Poles	PART NO	A	B
04	PH-2×2	2.00	5.9
06	PH-2×3	4.00	7.9
08	PH-2×4	6.00	9.9
10	PH-2×5	8.00	11.9
12	PH-2×6	10.00	13.9
14	PH-2×7	12.00	15.9
16	PH-2×8	14.00	17.9
18	PH-2×9	16.00	19.9
20	PH-2×10	18.00	21.9
22	PH-2×11	20.00	23.9
24	PH-2×12	22.00	25.9
26	PH-2×13	24.00	27.9
28	PH-2×14	26.00	29.9
30	PH-2×15	28.00	31.9
32	PH-2×16	30.00	33.9
34	PH-2×17	32.00	35.9
36	PH-2×18	34.00	37.9
38	PH-2×19	36.00	39.9
40	PH-2×20	38.00	41.9

UNIT: MM	TYPE: CONNECTOR	MODEL NO: PH-D-2×nY	日期 DATE YR/MO/DAY	08.7.25	页次1 OF 1 PAGE1 OF 1					
设计控制 DESIGNER BY	CHENGUANGQIAO	文件编号 DOCUMENT NUMBER	未注公差 TOLERANCE	± 0.15	角度公差 ANGLES	± 1.5°	比例 SCALE	FIT	版本 VER	1.0
绘制 DRAFTSMAN BY	WUZHENG FANG		审核 CHECKED BY	LIMINGMAO	供应商 COME OUT WITH		批准 APPROVED BY	LIUXUPING	BOOMELE	

## X-ON Electronics

Largest Supplier of Electrical and Electronic Components

*Click to view similar products for [Headers & Wire Housings](#) category:*

*Click to view products by [Boom](#) manufacturer:*

Other Similar products are found below :

[57102-F02-18ULF](#) [58102-G61-06LF](#) [0009485154](#) [009176003701906](#) [0050291907](#) [02.125.8002.8](#) [609-3404](#) [61062-3](#) [622-0430](#) [622-3653LF](#)  
[63453-116](#) [636-1030](#) [636-1427](#) [636-3427](#) [636-4007](#) [641938-9](#) [644827-2](#) [65495-038](#) [65692-001LF](#) [65781-018](#) [65781-047](#) [65817-010LF](#)  
[65817-015LF](#) [66207-023LF](#) [67016-026LF](#) [67095-007LF](#) [68631-112](#) [68645-018](#) [68648-049](#) [699319-000](#) [70.362.1628.0](#) [70-4210](#) [70-4226B](#)  
[70-4853B](#) [707-5020](#) [707-5028](#) [71.350.2428.0](#) [71961-016LF](#) [733-134](#) [754199-000](#) [760-3052](#) [787-8014-00](#) [FCN-367T-T012/H](#) [80.063.4001.1](#)  
[800-90-001-10-001000](#) [800-90-010-10-002000](#) [801-43-002-10-013000](#) [801-43-006-10-002000](#) [803-41-018-10-001000](#) [803-43-014-20-](#)  
[001000](#)