

◆ SPECIFICATIONS

Unit:mm

- ◇ Temperature: -10~70℃
- ◇ Rated Load: DC125V 1.5A
- ◇ Contact Resistance: ≤ 0.03Ω
- ◇ Insulation Resistance: ≥ 1000MΩ DC100V
- ◇ Withstand Voltage: AC 1000V(50Hz)/min
- ◇ Insertion and Extraction Force: 20~80N
- ◇ Life: ≥ 750cycles

RJ45-B-1x2

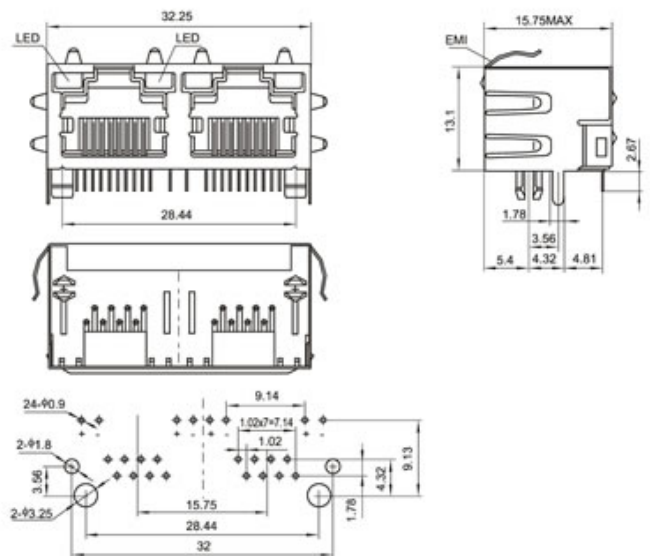

RJ45-B-1x1

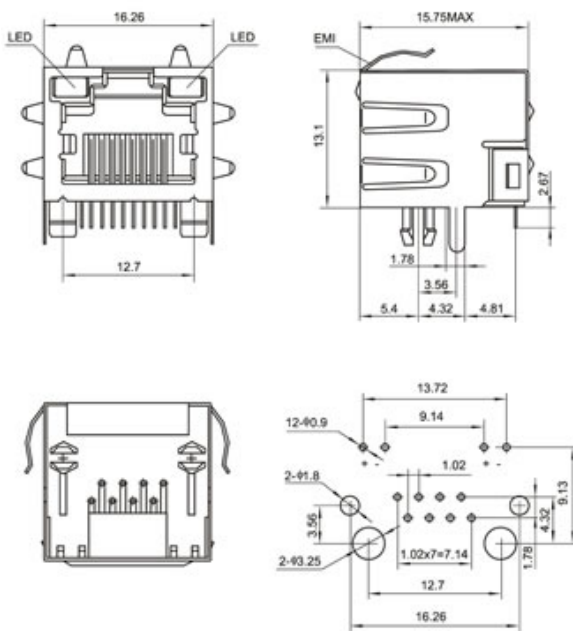

RJ45-B-1x4

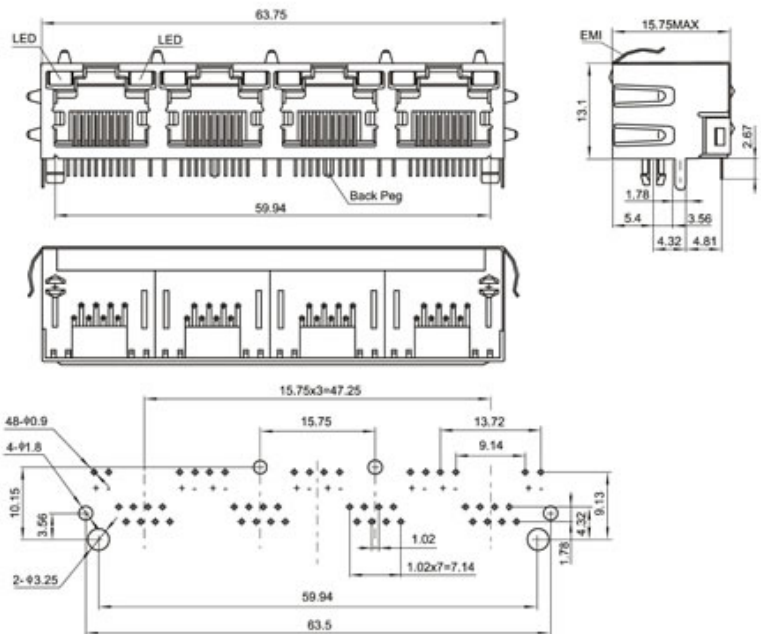

RJ45-B-1x6

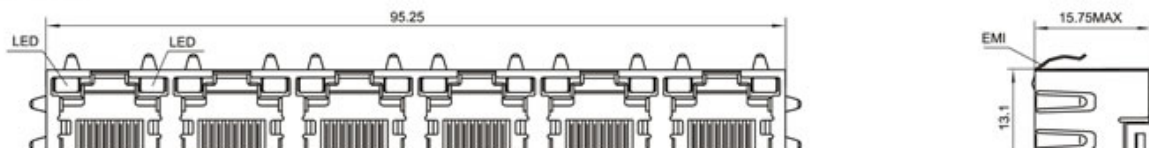

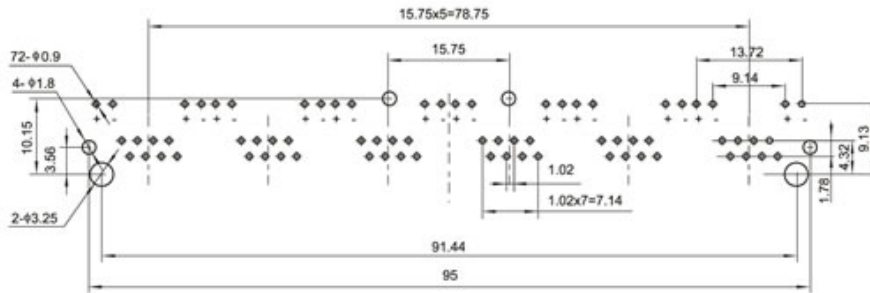
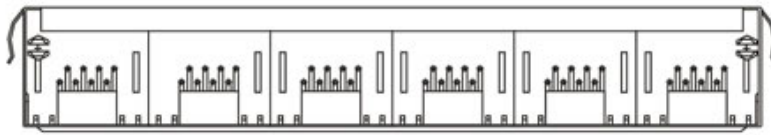
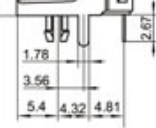
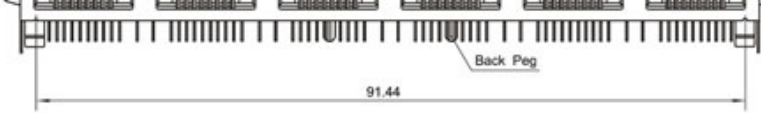

RJ45-B-1x8

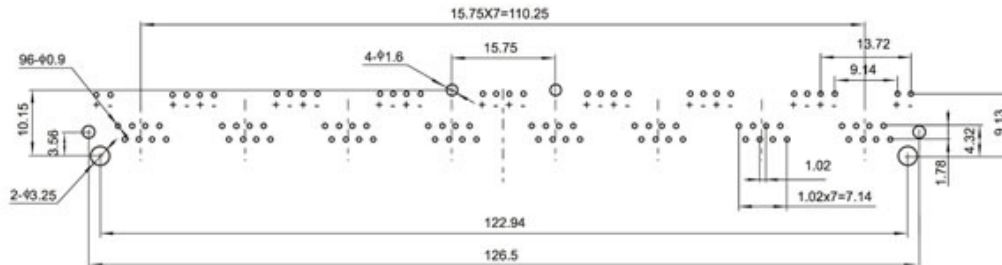
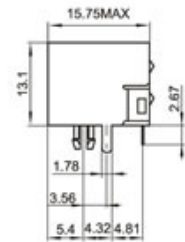
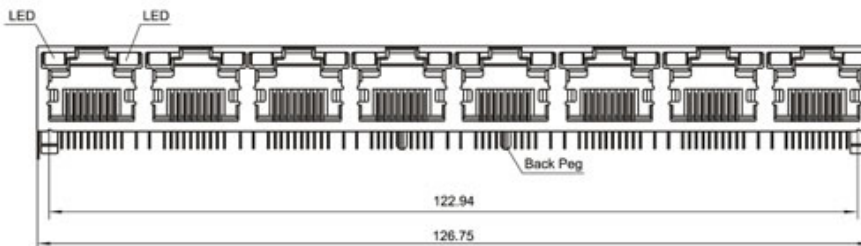

X-ON Electronics

Largest Supplier of Electrical and Electronic Components

Click to view similar products for [Modular Connectors / Ethernet Connectors](#) category:

Click to view products by [Boom](#) manufacturer:

Other Similar products are found below :

[8949-H88/06BLKA/SN](#) [74441-0010/BKN](#) [PHP-6P6C-5](#) [GAX-3-66](#) [GAX-8-62](#) [GDCX-PN-66](#) [GLX-A-44](#) [GLX-N-1010M-BLK](#) [GMX-SMT4-N-88](#) [GSGX-N-2-88](#) [GSGX-N-4-88](#) [GSX-NS2-88-3.05](#) [GSX-NS-88-3.68](#) [PT-108A-8C-UL](#) [PTS-J531-8CS-50UL](#) [1-1775629-2](#) [A-2014-0-4](#) [GWLX-S9-88-YG](#) [DC-1021-8-WH-6](#) [1300530003](#) [1324640-4](#) [RJ11FTVC2G](#) [RJ11FTVC2N](#) [RJFTVX2SA1G](#) [132764-001](#) [1413235](#) [MPS88RX-5000](#) [E5288-S000K3-L](#) [155302-001](#) [AX101050](#) [AX101063](#) [AX101065](#) [AX101072](#) [AX101307](#) [AX101314](#) [AX101315](#) [AX101318](#) [AX102271](#) [AX102288](#) [AX102651](#) [AX102660](#) [HXJ5EOR](#) [J0012D21NL](#) [J0026D01ENL](#) [PC4D0018P](#) [8949-B88/6](#) [2-6609208-5](#) [937-SP-3088-2PC-A192](#) [303066VFL](#) [303068V](#)