

◆ SPECIFICATIONS

Unit:mm

- ◇ Poles: 2~16
- ◇ Applicable wire: AWG#22-#32
- ◇ Voltage rating: 250V DC/AC
- ◇ Current rating: 3.0A
- ◇ Withstand voltage: 1000V AC
- ◇ Working Temperature: -25°C ~ +85°C
- ◇ Insulation resistance: $\geq 1000M\Omega$
- ◇ Contact resistance: $\leq 0.02\Omega$
- ◇ Applicable PC board thickness: 1.6mm

UL:Recognized No.E309635
RoHS-specification and
Halogen-free products

XH-nY

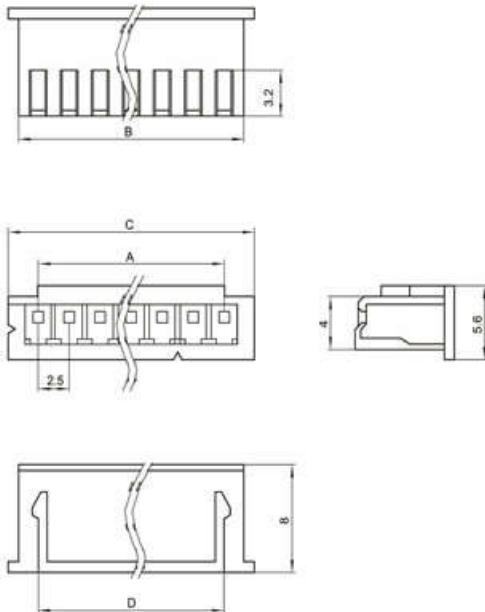

XH-nA

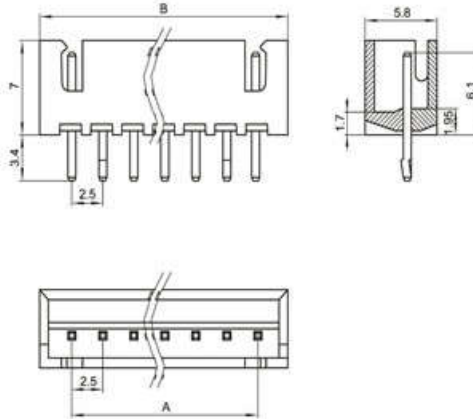

XH-nAW

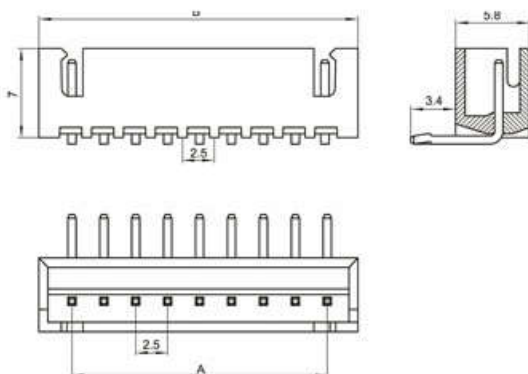

XH-nAWD

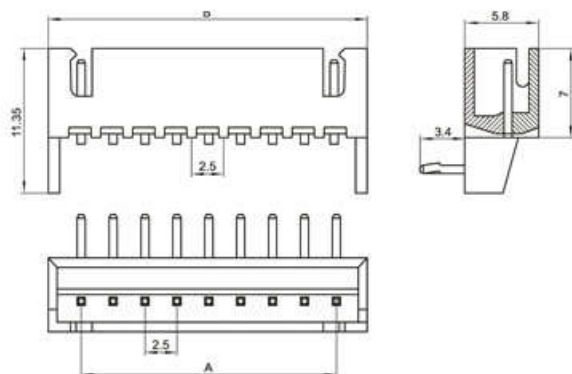

Unit:mm

XH-PT

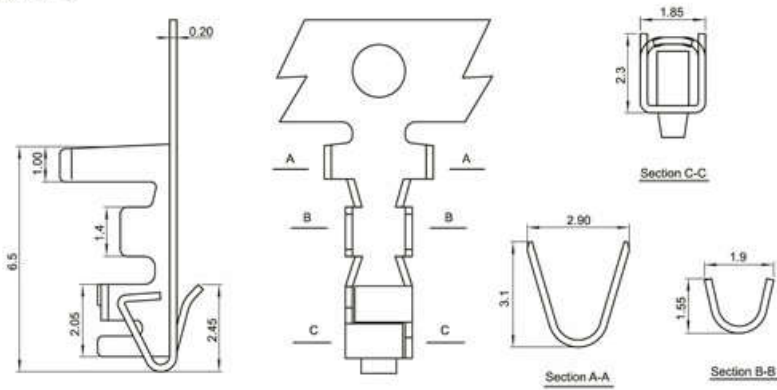

Mounting Measurement

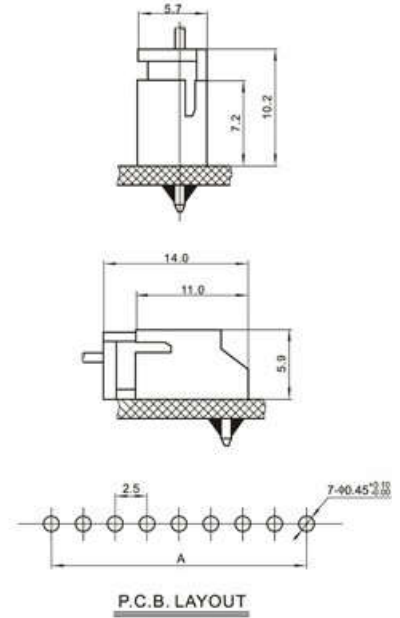

Terminal(XH)

Type	Applicable wires		O.D of wire ins	Material	Finish
	mm ²	AWG#	mm		
BM-XH	0.08-0.3	24-32	1.2-1.9	Phos.bronze	Tin-plated

Poles	Type	Size(mm)			
		A	B	C	D
2	XH-2Y	2.5	5.7	7.5	2.5
3	XH-3Y	5.0	8.2	10.0	5.0
4	XH-4Y	7.5	10.7	12.5	7.5
5	XH-5Y	10.0	13.2	15.0	10.0
6	XH-6Y	12.5	15.7	17.5	12.5
7	XH-7Y	15.0	18.3	20.0	15.0
8	XH-8Y	17.5	20.8	22.5	17.5
9	XH-9Y	20.0	23.3	25.0	20.0
10	XH-10Y	22.5	25.7	27.5	22.5
11	XH-11Y	25.0	28.3	30.0	25.0
12	XH-12Y	27.5	30.7	32.5	27.5
13	XH-13Y	30.0	33.2	35.0	30.0
14	XH-14Y	32.5	35.7	37.5	32.5
15	XH-15Y	35.0	38.3	40.0	35.1
16	XH-16Y	37.5	40.8	42.5	37.6

Poles	Type	Size(mm)	
		A	B
2	XH-2A	2.5	7.5
3	XH-3A	5.0	10.0
4	XH-4A	7.5	12.5
5	XH-5A	10.0	15.0
6	XH-6A	12.5	17.5
7	XH-7A	15.0	20.0
8	XH-8A	17.5	22.5
9	XH-9A	20.0	25.0
10	XH-10A	22.5	27.5
11	XH-11A	25.0	30.0
12	XH-12A	27.5	32.5
13	XH-13A	30.0	35.0
14	XH-14A	32.5	37.5
15	XH-15A	35.0	40.0
16	XH-16A	37.5	42.5

X-ON Electronics

Largest Supplier of Electrical and Electronic Components

Click to view similar products for [Headers & Wire Housings](#) category:

Click to view products by [Boom](#) manufacturer:

Other Similar products are found below :

[57102-F02-18ULF](#) [58102-G61-06LF](#) [0009485154](#) [009176003701906](#) [0050291907](#) [02.125.8002.8](#) [609-3404](#) [61062-3](#) [622-0430](#) [622-3653LF](#)
[63453-116](#) [636-1030](#) [636-1427](#) [636-3427](#) [636-4007](#) [641938-9](#) [644827-2](#) [65495-038](#) [65692-001LF](#) [65781-018](#) [65781-047](#) [65817-010LF](#)
[65817-015LF](#) [66207-023LF](#) [67016-026LF](#) [67095-007LF](#) [68631-112](#) [68645-018](#) [68648-049](#) [699319-000](#) [70.362.1628.0](#) [70-4210](#) [70-4226B](#)
[70-4853B](#) [707-5020](#) [707-5028](#) [71.350.2428.0](#) [71961-016LF](#) [733-134](#) [754199-000](#) [760-3052](#) [787-8014-00](#) [FCN-367T-T012/H](#) [80.063.4001.1](#)
[800-90-001-10-001000](#) [800-90-010-10-002000](#) [801-43-002-10-013000](#) [801-43-006-10-002000](#) [803-41-018-10-001000](#) [803-43-014-20-](#)
[001000](#)