

端子 TERMINAL(XH)

型号Type	适用线规Applicable wires		电线外径O.D of wire ins
	mm ²	AWG#	mm
XH-PT	0.08-0.33	28-22	1.2-1.9

XH-PT

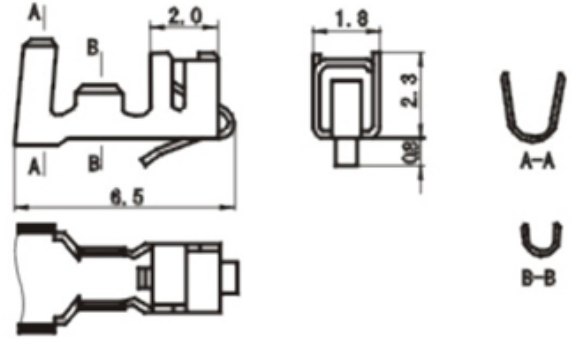

XH-Y

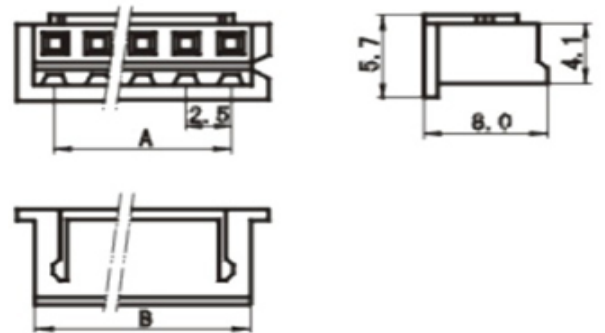

XH-A

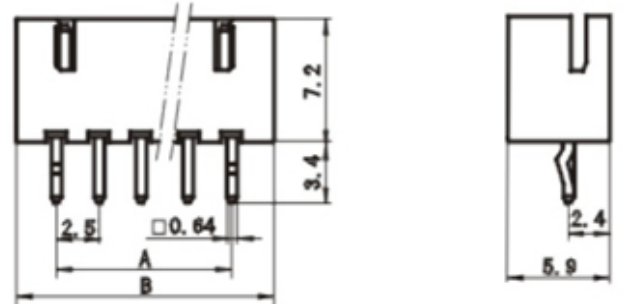

XH-WAP1

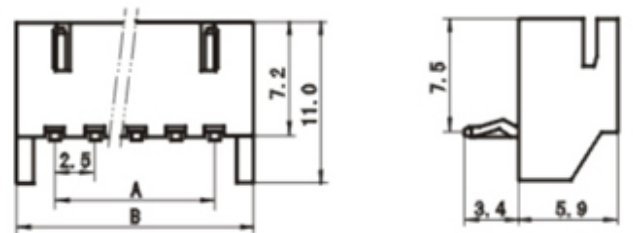

XH-WAP2

技术参数SPECIFICATIONS

- 线数 (poles) : 2 ~ 20
- 适用线规 (Applicable wires) : AWG28# ~ 22#
- 适应基板厚度 (Applicable PC board thickness) : 1.6mm
- 温度范围 (Temperature range) : -25 ~ 85
- 额定电压 (Voltage rating) : 250V.Ac/Dc
- 额定电流 (Current rating) : 3A
- 接触电阻 (Contact resistance) : 0.02
- 绝缘电阻 (Insulation resistance) : 1000M
- 耐压 (Withstand voltage) : 1000V.Ac/1分钟(Minute)
- 材料 (Material) :
 孔座 (Housing) : 尼龙 (Nylon) UL94V-0
 针座 (Wafer) : 尼龙 (Nylon) UL94V-0
 端子 (Terminal) : 磷青铜 (Phos.bronze Tin/plated)

孔座HOUSING (PH)

线数 Poles	型号 Type	尺寸 Dimensions(mm)	
		A	B
2	XH-2Y	2.5	5.7
3	XH-3Y	5.0	8.2
4	XH-4Y	7.5	10.7
5	XH-5Y	10.0	13.2
6	XH-6Y	12.5	15.7
7	XH-7Y	15.0	18.2
8	XH-8Y	17.5	20.7
9	XH-9Y	20.0	23.2

10	XH-10Y	22.5	25.7
11	XH-11Y	25.0	28.2
12	XH-12Y	27.5	30.7
13	XH-13Y	30.0	33.2
14	XH-14Y	32.5	35.7
15	XH-15Y	35.0	38.2
16	XH-16Y	37.5	40.7
17	XH-17Y	40.0	43.2
18	XH-18Y	42.5	45.7
19	XH-19Y	45.0	48.2
20	XH-20Y	47.5	50.7

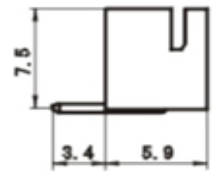
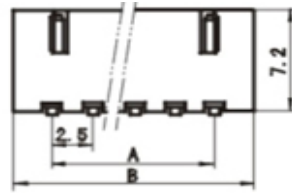

XH-WAG

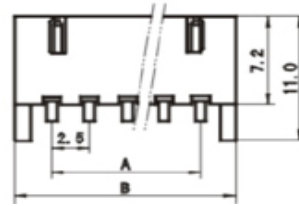

安装尺寸 MOUNTING MEASUREMENT

针座 WAEER (PH)

线数 Poles	型号 Type		尺寸	
	直式 (180 °)	弯式 (90 °)	Dimensions(mm)	
			A	B
2	XH-2A	XH-2WA	2.5	7.4
3	XH-3A	XH-3WA	5.0	9.9
4	XH-4A	XH-4WA	7.5	12.4
5	XH-5A	XH-5WA	10.0	14.9
6	XH-6A	XH-6WA	12.5	17.4
7	XH-7A	XH-7WA	15.0	19.9
8	XH-8A	XH-8WA	17.5	22.4
9	XH-9A	XH-9WA	20.0	24.9
10	XH-10A	XH-10WA	22.5	27.4
11	XH-11A	XH-11WA	25.0	29.9
12	XH-12A	XH-12WA	27.5	32.4
13	XH-13A	XH-13WA	30.0	34.9
14	XH-14A	XH-14WA	32.5	37.4
15	XH-15A	XH-15WA	35.0	39.9
16	XH-16A	XH-16WA	37.5	42.4
17	XH-17A	XH-17WA	40.0	44.9
18	XH-18A	XH-18WA	42.5	47.4
19	XH-19A	XH-19WA	45.0	49.9
20	XH-20A	XH-20WA	47.5	52.4

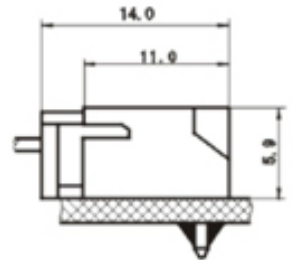
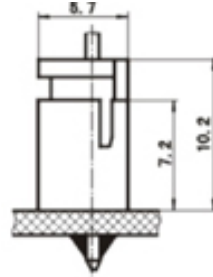
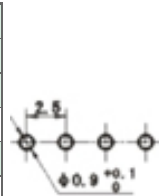

X-ON Electronics

Largest Supplier of Electrical and Electronic Components

Click to view similar products for [Headers & Wire Housings](#) category:

Click to view products by [Boom](#) manufacturer:

Other Similar products are found below :

[57102-F02-18ULF](#) [58102-G61-06LF](#) [0009485154](#) [009176003701906](#) [0050291907](#) [02.125.8002.8](#) [609-3404](#) [61062-3](#) [622-0430](#) [622-3653LF](#)
[63453-116](#) [636-1030](#) [636-1427](#) [636-3427](#) [636-4007](#) [641938-9](#) [644827-2](#) [65495-038](#) [65692-001LF](#) [65781-018](#) [65781-047](#) [65817-010LF](#)
[65817-015LF](#) [66207-023LF](#) [67016-026LF](#) [67095-007LF](#) [68631-112](#) [68645-018](#) [68648-049](#) [699319-000](#) [70.362.1628.0](#) [70-4210](#) [70-4226B](#)
[70-4853B](#) [707-5020](#) [707-5028](#) [71.350.2428.0](#) [71961-016LF](#) [733-134](#) [754199-000](#) [760-3052](#) [787-8014-00](#) [FCN-367T-T012/H](#) [80.063.4001.1](#)
[800-90-001-10-001000](#) [800-90-010-10-002000](#) [801-43-002-10-013000](#) [801-43-006-10-002000](#) [803-41-018-10-001000](#) [803-43-014-20-001000](#)