

REV.	DESCRIPTION	APPD	DATE

A

B

C

E

F

A

B

C

D

E

F

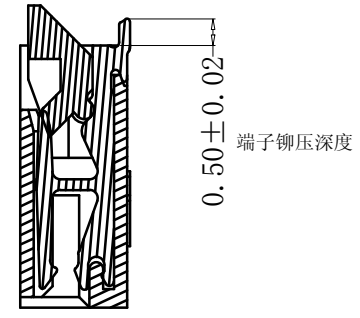
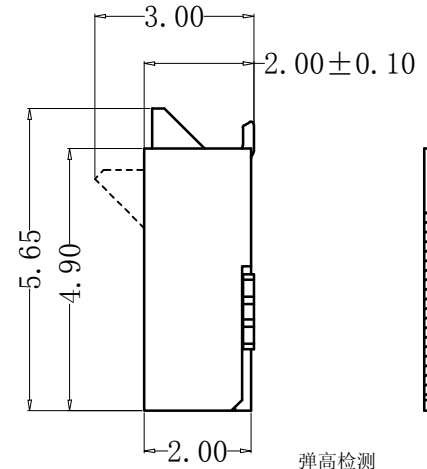
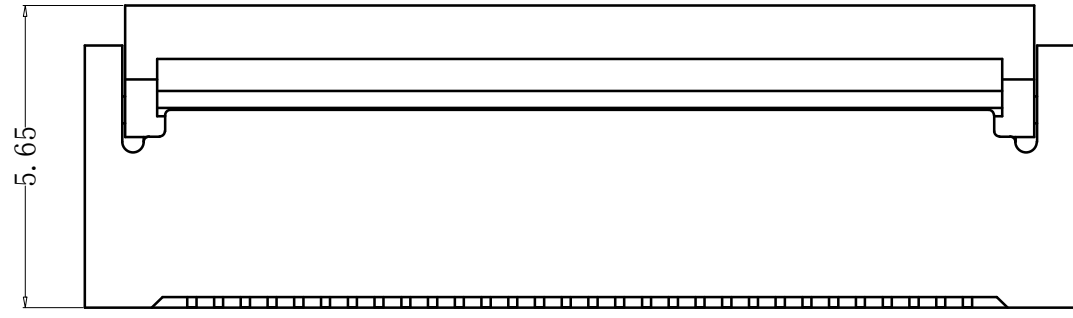

弹高检测

弹高检测

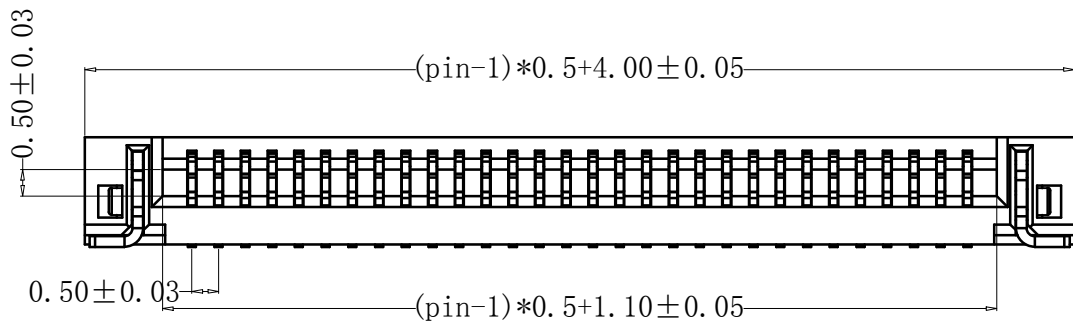

NOTES:

- MATERIAL:  
HOUSING: HIGH TEMPERATURE THERMOPLASTIC UL94V\_0,COLOR:BLACK.  
CONTACT: COPPER ALLOYS.
- PLATING:  
UNDERPLATE: NICKEL.  
CONTACT AREA: TIN OVER NICKEL.
- MULTIMEDIA CARD COMPATIBLE

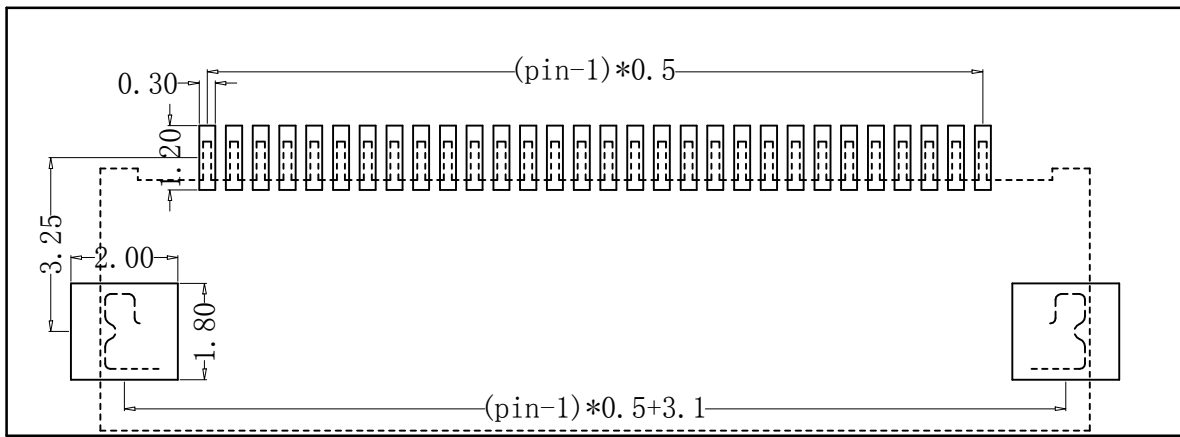
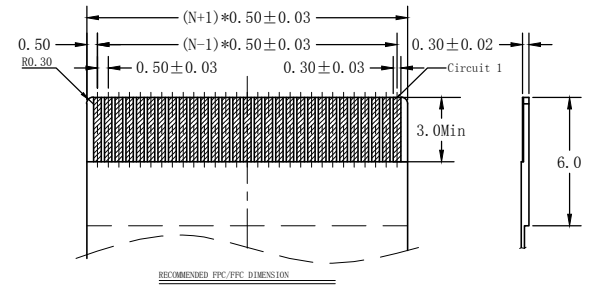

PART NO:		MATERIAL:			
LOT NO:		FINSH:			
UNIT:	MM	SIZE:	A4	COLOR:	TITLE:
TOLERANCES: X.X=±0.35 X.XX=±0.25 X.XXX=±0.15		GENERAL ANGLE: X.X=±3.0° X.XX=±2.0°		DR:	0.5间距 60P 后翻 卧贴 上下接 H2.0
		CHK:	Zhou qi	DWG NO:	BX-FPC05-2H60PSX
		APP:		SCALE:	1:1
				SHEET:	1 OF 1
				REV:	C/O

## X-ON Electronics

Largest Supplier of Electrical and Electronic Components

*Click to view similar products for [FFC & FPC Connectors](#) category:*

*Click to view products by [Bossie](#) manufacturer:*

Other Similar products are found below :

[00-6200-227-022-800](#) [006205250500825+](#) [006205280500825+](#) [FPH-1602G](#) [086222026001800](#) [52610-0675](#) [62674-201121DLF](#) [52746-1671-TR250](#) [10051922-1610EHLF](#) [10051922-2810EHLF](#) [686322124422](#) [XF3M-2915-1B-R100](#) [AYF353125A](#) [AYF530665TA](#) [AYF534065TA](#) [20FLH-RSM1-TB](#) [PCA-7F-25-HL-3-G](#) [207356-1](#) [52807-0430](#) [FFC05011-10SBB114W5M](#) [502250-8027](#) [FH28K-40S-0.5SH](#) [200528-0260](#) [FH28K-10S-0.5SH](#) [501951-1250](#) [X05B20U43T](#) [0.5K-DX-30PWB](#) [DS1020-08-10VBT12](#) [THD0515-34CL-GF](#) [X05A10L28G](#) [ECC2841061EU](#) [20539-030E-01](#) [1.0K-DHQX-16PWB](#) [1.0K-DHQX-30PWB](#) [1775333-6](#) [10054365-202110ELF](#) [10054365-242110ELF](#) [10054365-282110ELF](#) [10064555-392220HLF](#) [59453-041110EBHLF](#) [59453-091110EDHLF](#) [62674-241141ALF](#) [62684-432100ALF](#) [62684-451100AHLF](#) [62684-5721N0ALF](#) [HFW11R-1STE1MTLF](#) [HFW12R-1STE9LF](#) [HFW14R-1STE9MTLF](#) [HFW18S-2STE9LF](#) [HFW20R-1STAE1HLF](#)