

标记 MARK.	更改内容 MODIFICATION	日期 DATE	修改 DRAW	核准 APPROVE

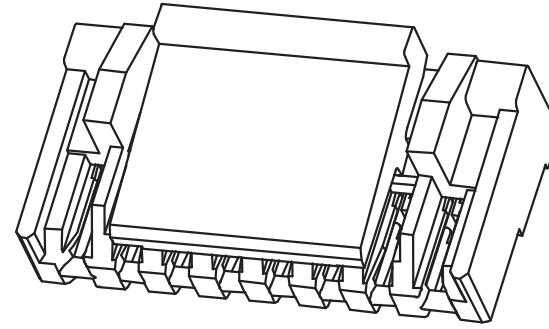
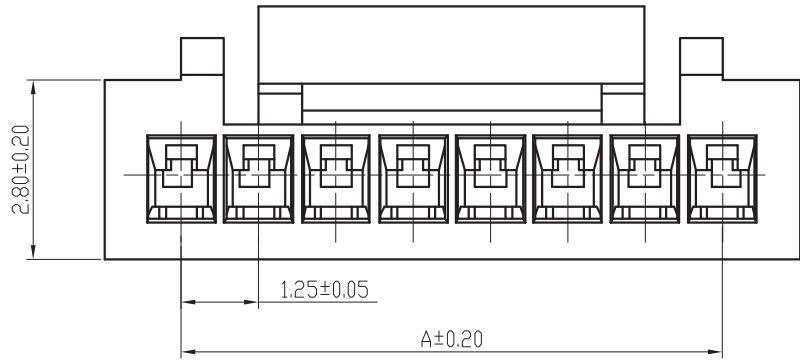

技术要求Specification:

- 1、材质Material: PA66 UL94V-0;
- 2、额定电流 Current rating:1.0A AC,DC
- 3、额定电压 Voltage rating: 50V AC,DC
- 4、温度范围 Temperature range:-25℃to+85℃
- 5、接触电阻 Contact resistance:≤30mΩ
- 6、绝缘电阻 Insulation resistance:≥100MΩ
- 7、耐压 Withstand voltage:500V AC/minute
- 8、塑件表面平整光洁, 无明显的毛刺、气泡、变形、浇口拉伤、缺料等不良现象。

Plastic surface smooth and clean, no obvious burrs, bubbles, distortion, gate strain, lack of material and other undesirable phenomena.

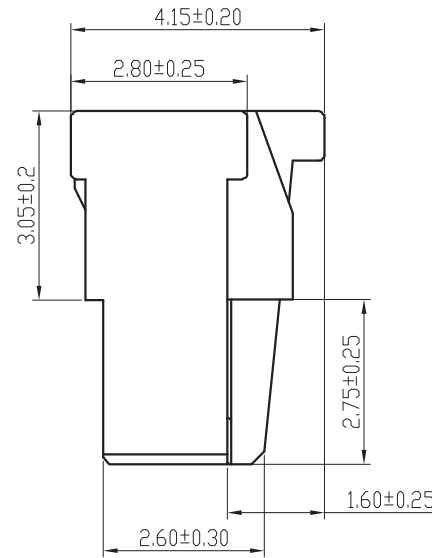
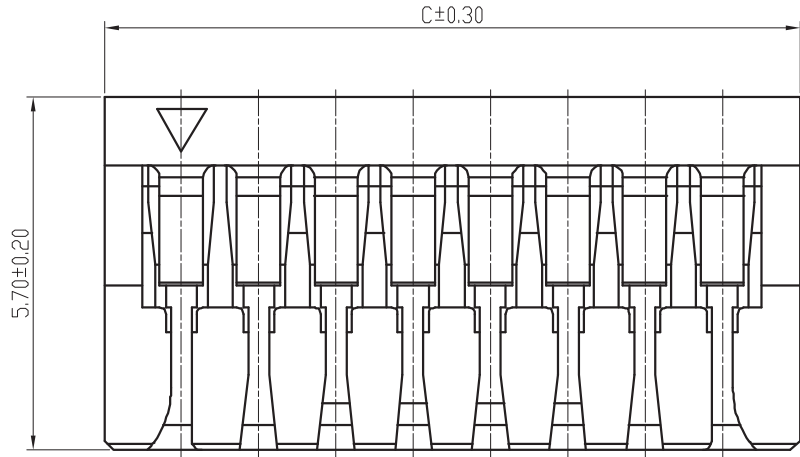

线数	型号	尺寸			
		A	B	C	D
2	SH12512-2Y	1.25	2.00	3.75	---
3	SH12512-3Y	2.50	3.20	5.00	---
4	SH12512-4Y	3.75	4.30	6.25	---
5	SH12512-5Y	5.00	4.30	7.50	6.25
6	SH12512-6Y	6.25	6.25	8.75	8.75
7	SH12512-7Y	7.50	6.25	10.00	8.75
8	SH12512-8Y	8.75	6.25	11.25	8.75
9	SH12512-9Y	10.00	6.25	12.50	8.75
10	SH12512-10Y	11.25	8.30	13.75	10.70
	SH12512-11Y	12.50	8.30	15.00	10.70
	SH12512-12Y	13.75	8.30	16.25	10.70
	SH12512-13Y	15.00	8.30	17.50	10.70
	SH12512-14Y	16.25	8.30	18.75	10.70
	SH12512-15Y	17.50	8.30	20.00	10.70
	SH12512-16Y	18.75	8.30	21.25	---

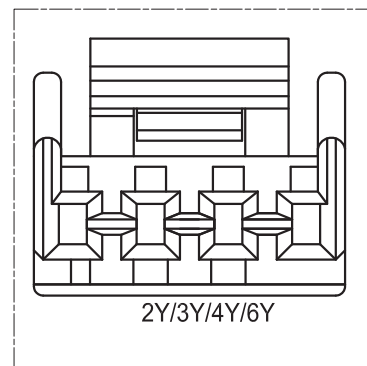
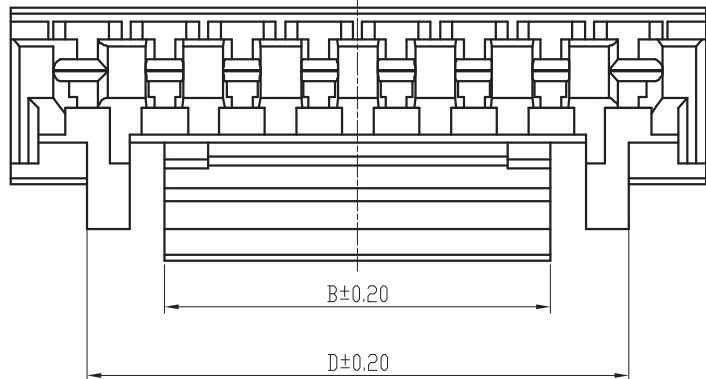

OTHERWISE SPECIFIED		☞: Inspection Item					
.X±0.30	X.° ±1°	☉:Cp/Cpk and SPC Control Item					
.XX±0.20	.X° ±	材料 MATERIAL	PA66	名称 TITLE	GH1.25胶壳-2Pin		
.XXX±0.10	.XX° ±	料厚 THICK		编号 DWG NO.	BX-GH1.25-2PJK	单位 UNIT	m m
制图 DRAWIN		料宽 WIDE		比例 SCALE	1:1	版本 R E V.	A
审核 CHECKED	Zhou qi	日期 DATE		角法 PROJ.			规格书
批准 APPROVE							

X-ON Electronics

Largest Supplier of Electrical and Electronic Components

Click to view similar products for [Headers & Wire Housings](#) category:

Click to view products by [Bossie](#) manufacturer:

Other Similar products are found below :

[0015917161](#) [0022155065](#) [57102-F02-18ULF](#) [58102-G61-06LF](#) [582553-1](#) [01.001.5753.1](#) [0050291907](#) [02.125.8002.8](#) [609-3404](#) [61062-3](#)
[CSU011177004](#) [622-0430](#) [622-3653LF](#) [63453-116](#) [636-1030](#) [636-1427](#) [636-3427](#) [636-4007](#) [641938-9](#) [65495-038](#) [65692-001LF](#) [65781-018](#)
[65781-047](#) [65817-010LF](#) [65817-015LF](#) [67095-007LF](#) [67601157](#) [68631-112](#) [68645-018](#) [699319-000](#) [70.362.1628.0](#) [70-4210](#) [70-4226B](#) [70-](#)
[4853B](#) [71.350.2428.0](#) [733-134](#) [733-162](#) [760-3052](#) [MHR-64-VUAL](#) [80.063.4001.1](#) [800-90-001-10-001000](#) [801-43-002-10-013000](#)
[801-43-006-10-002000](#) [803-43-024-10-001000](#) [803-93-012-10-001000](#) [8-1437020-4](#) [819-22-004-30-001101](#) [820-22-006-30-001101](#)
[820-22-008-30-001101](#) [821-22-002-10-001101](#)