

|         |      |    |    |                |                 |
|---------|------|----|----|----------------|-----------------|
| 版次<br>0 | 变更摘要 | 日期 | 序号 | 品名             | 材质              |
|         |      |    | ①  | MX3.0双排直针WTB胶芯 | PA66 UL94V-0 黑色 |
|         |      |    | ②  | MX3.0双排直针WTB端子 | 铜合金/表面镀锡        |

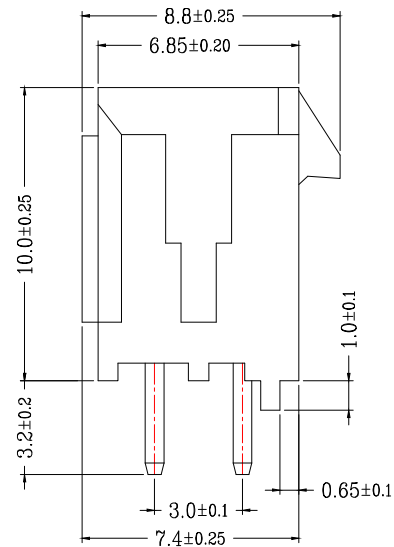

TYPE 1(无K脚)

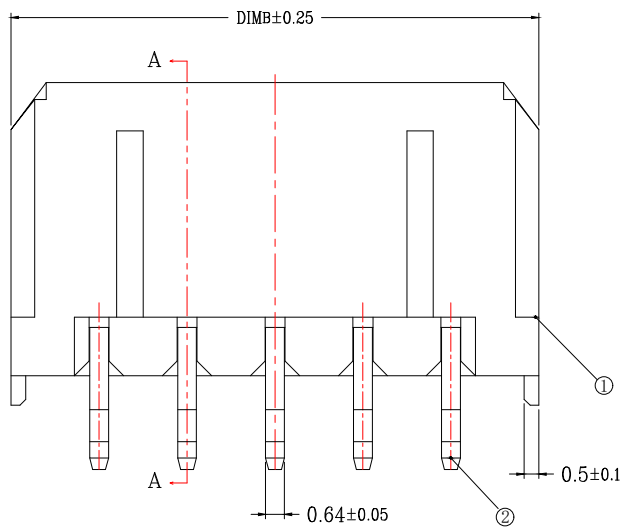
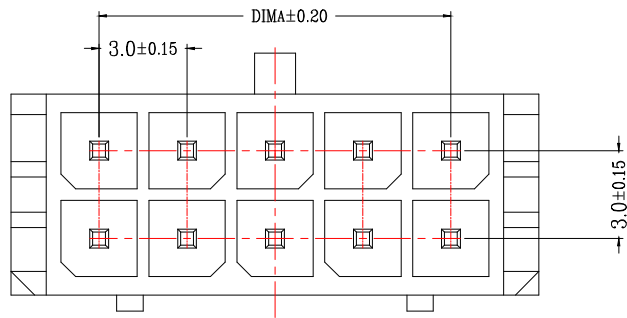
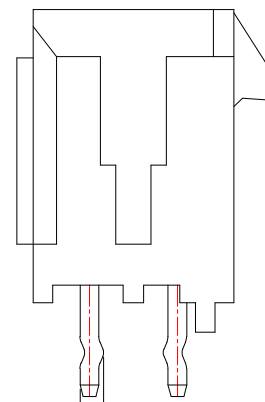

TYPE 2(打K脚)

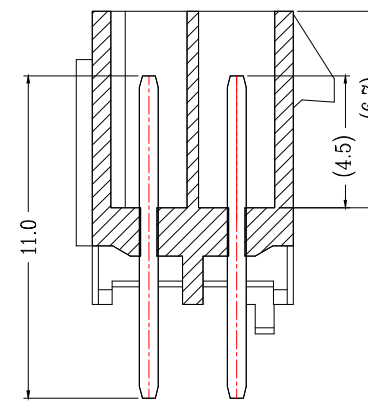
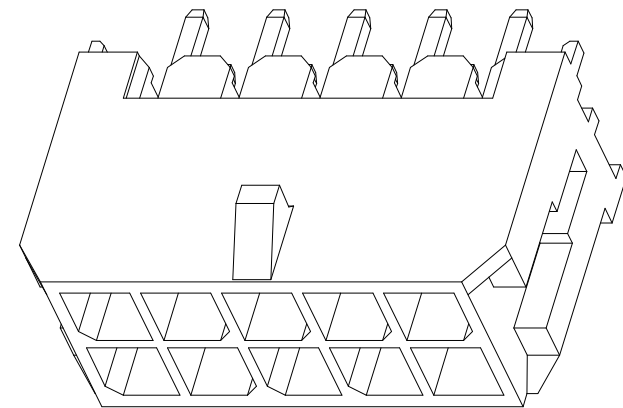

SECTION A-A

| CKT  | A    | B     |
|------|------|-------|
| 2*1  |      | 6.00  |
| 2*2  | 3.0  | 9.00  |
| 2*3  | 6.0  | 12.00 |
| 2*4  | 9.0  | 15.00 |
| 2*5  | 12.0 | 18.00 |
| 2*6  | 15.0 | 21.00 |
| 2*7  | 18.0 | 24.00 |
| 2*8  | 21.0 | 27.00 |
| 2*9  | 24.0 | 30.00 |
| 2*10 | 27.0 | 33.00 |
| 2*11 | 30.0 | 36.00 |
| 2*12 | 33.0 | 39.00 |

技术指标(Technical Index):

1. 温度范围(Temperature range): -25° C~+85° C.
2. 额定电压(Rated voltage): 600V, AC, DC.
3. 额定电流(Rated current): 5.0A AC, DC.
4. 接触电阻(Contact resistance): ≤20mΩ .
5. 耐压值(Withstanding voltage): 1500V AC/minute.
6. 绝缘电阻(Insulation resistance): ≥1000MΩ.

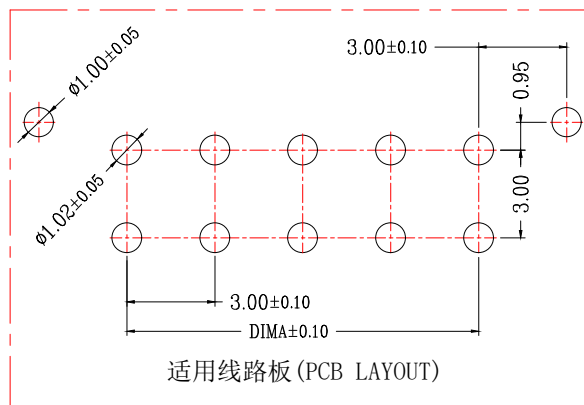

适用线路板(PCB LAYOUT)



一般公差(TOLERANCE)  
 X: ±.50 XX: ±1.0  
 .X: ±.20 .XXX: ±.05  
 ANGLES: ±1°



|            |                 |           |        |
|------------|-----------------|-----------|--------|
| 品名(TITLE)  | MX3.0双排直针WTB    | 制图(DR)    |        |
| 料号(DWG.NO) | BX-MX3.0-2-7PZZ | 校对(CHKD)  |        |
| 比例(SCALE)  | 1:1             | 审核(APPD)  |        |
| 单位(UNITS)  | mm              | 张数(SHEET) | 1 OF 1 |
|            |                 | SIZE      | A4     |
|            |                 | REV       | A      |

## X-ON Electronics

Largest Supplier of Electrical and Electronic Components

*Click to view similar products for [Headers & Wire Housings](#) category:*

*Click to view products by [Bossie](#) manufacturer:*

Other Similar products are found below :

[0015917161](#) [0022155065](#) [57102-F02-18ULF](#) [58102-G61-06LF](#) [582553-1](#) [01.001.5753.1](#) [0050291907](#) [02.125.8002.8](#) [609-3404](#) [61062-3](#)  
[CSU011177004](#) [622-0430](#) [622-3653LF](#) [63453-116](#) [636-1030](#) [636-1427](#) [636-3427](#) [636-4007](#) [641938-9](#) [65495-038](#) [65692-001LF](#) [65781-018](#)  
[65781-047](#) [65817-010LF](#) [65817-015LF](#) [67095-007LF](#) [67601157](#) [68631-112](#) [68645-018](#) [699319-000](#) [70.362.1628.0](#) [70-4210](#) [70-4226B](#) [70-](#)  
[4853B](#) [71.350.2428.0](#) [733-134](#) [733-162](#) [760-3052](#) [MHR-64-VUAL](#) [80.063.4001.1](#) [800-90-001-10-001000](#) [801-43-002-10-013000](#)  
[801-43-006-10-002000](#) [803-43-024-10-001000](#) [803-93-012-10-001000](#) [8-1437020-4](#) [819-22-004-30-001101](#) [820-22-006-30-001101](#)  
[820-22-008-30-001101](#) [821-22-002-10-001101](#)