

标记 MARK.	更改内容 MODIFICATION	日期 DATE	修改 DRAW	核准 APPROVE

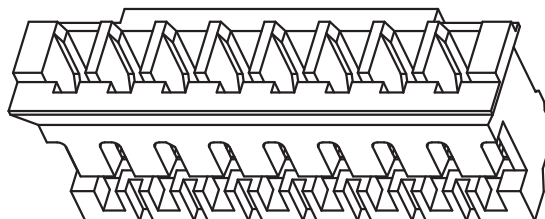
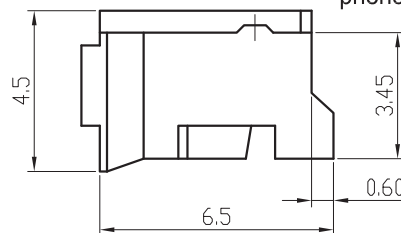
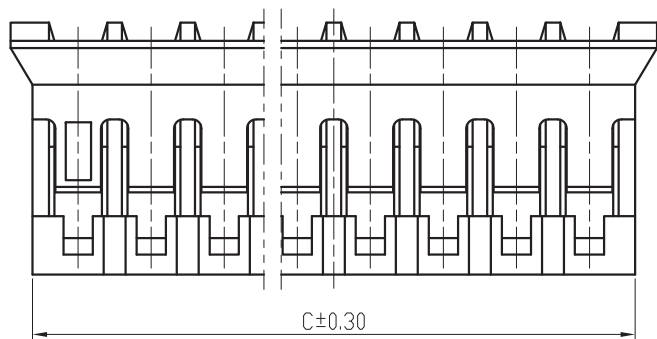
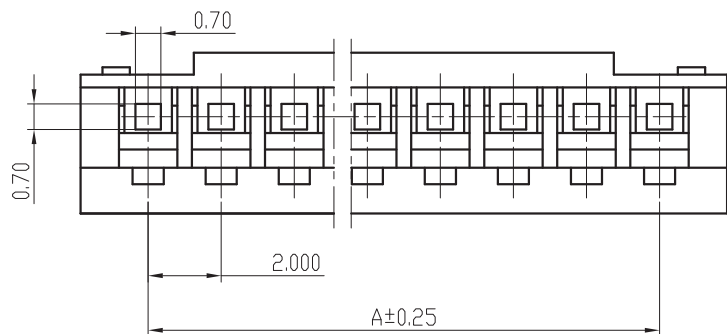
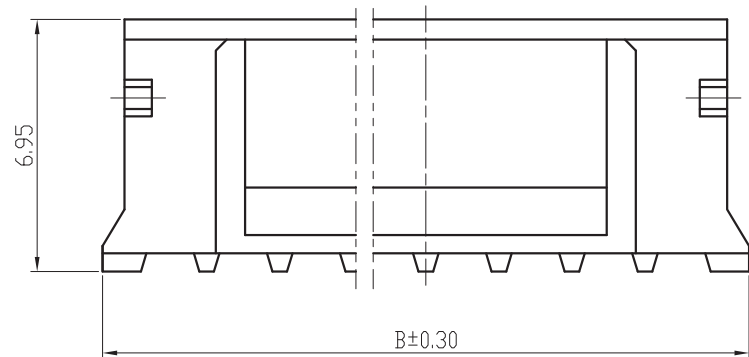

技术要求Specification:

- 1、材质Material: PA66 UL94V-0;
- 2、额定电流 Current rating:2.0A AC,DC
- 3、额定电压 Voltage rating: 100V AC,DC
- 4、温度范围 Temperature range:-25℃to+85℃
- 5、接触电阻 Contact resistance:≤20mΩ
- 6、绝缘电阻 Insulation resistance:≥1000MΩ
- 7、耐压 Withstand voltage:800V AC/minute
- 8、塑件表面平整光洁, 无明显的毛刺、气泡、变形、浇口拉伤、缺料等不良现象。

Plastic surface smooth and clean, no obvious burrs, bubbles, distortion, gate strain, lack of material and other undesirable phenomena.

线数	型号	尺寸		
		A	B	C
2	SH20001-2Y	2.00	5.70	4.50
3	SH20001-3Y	4.00	7.70	6.50
4	SH20001-4Y	6.00	9.70	8.50
5	SH20001-5Y	8.00	11.70	10.50
6	SH20001-6Y	10.00	13.70	12.50
7	SH20001-7Y	12.00	15.70	14.50
8	SH20001-8Y	14.00	17.70	16.50
9	SH20001-9Y	16.00	19.70	18.50
10	SH20001-10Y	18.00	21.70	20.50
11	SH20001-11Y	20.00	23.70	22.50
12	SH20001-12Y	22.00	25.70	24.50
13	SH20001-13Y	24.00	27.70	26.50
14	SH20001-14Y	26.00	29.70	28.50
15	SH20001-15Y	28.00	31.70	30.50
16	SH20001-16Y	30.00	33.70	32.50

TOLERANCE UNLESS OTHERWISE SPECIFIED		*: Inspection Item					
.X±0.30	X.° ±1°	 :Cp/Cpk and SPC Control Item	材料			PA66	名称
.XX±0.2	.X° ±		料厚		编号	BX-PH2.0-5PJk	单位
.XXX±0.10	.XX° ±	料宽		比例	1:1	版本	A1
制图		日期		角法		规格书	
审核							
批准							

X-ON Electronics

Largest Supplier of Electrical and Electronic Components

Click to view similar products for [Headers & Wire Housings](#) category:

Click to view products by [Bossie](#) manufacturer:

Other Similar products are found below :

[0015917161](#) [0022155065](#) [57102-F02-18ULF](#) [58102-G61-06LF](#) [582553-1](#) [01.001.5753.1](#) [0050291907](#) [02.125.8002.8](#) [609-3404](#) [61062-3](#)
[CSU011177004](#) [622-0430](#) [622-3653LF](#) [63453-116](#) [636-1030](#) [636-1427](#) [636-3427](#) [636-4007](#) [641938-9](#) [65495-038](#) [65692-001LF](#) [65781-018](#)
[65781-047](#) [65817-010LF](#) [65817-015LF](#) [67095-007LF](#) [67601157](#) [68631-112](#) [68645-018](#) [699319-000](#) [70.362.1628.0](#) [70-4210](#) [70-4226B](#) [70-](#)
[4853B](#) [71.350.2428.0](#) [733-134](#) [733-162](#) [760-3052](#) [MHR-64-VUAL](#) [80.063.4001.1](#) [800-90-001-10-001000](#) [801-43-002-10-013000](#)
[801-43-006-10-002000](#) [803-43-024-10-001000](#) [803-93-012-10-001000](#) [8-1437020-4](#) [819-22-004-30-001101](#) [820-22-006-30-001101](#)
[820-22-008-30-001101](#) [821-22-002-10-001101](#)