

	0.10	MAX
	0.12	MAX

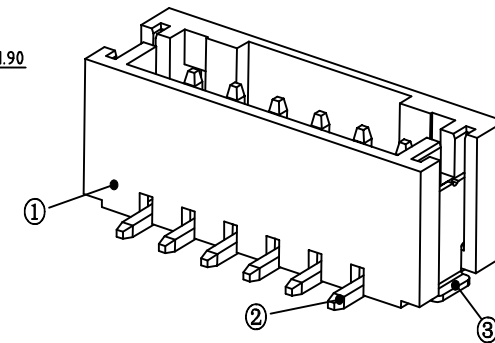
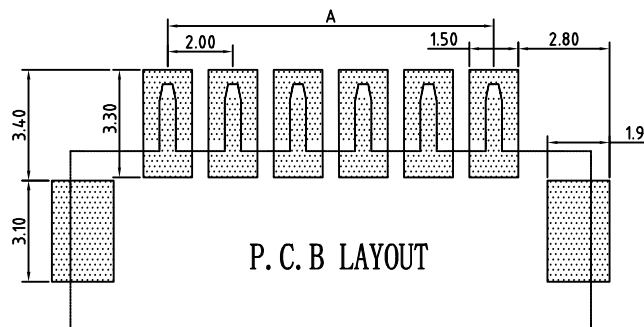
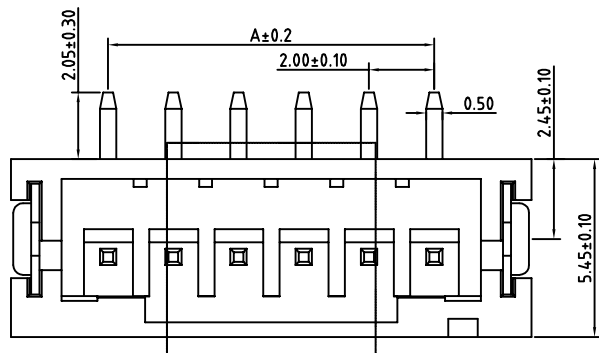
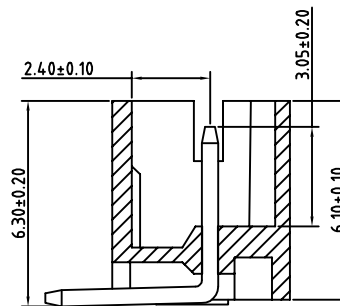
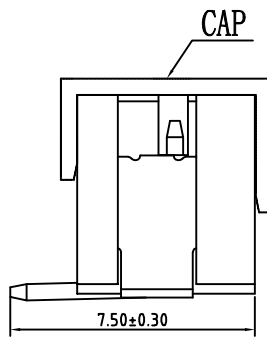

Pin	A	B
2	2.00	8.00
3	4.00	10.00
4	6.00	12.00
5	8.00	14.00
6	10.00	16.00
7	12.00	18.00
8	14.00	20.00
9	16.00	22.00
10	18.00	24.00
11	20.00	26.00
12	22.00	28.00
13	24.00	30.00
14	26.00	32.00
15	28.00	34.00
16	30.00	36.00

技术参数

间距: 2.0
 温度范围: -25~+85°C
 额定电压: 250V AC, DC
 额定电流: 2.0A AC, DC
 接触电阻: 20mΩ
 绝缘电阻: 800MΩ
 耐压: 500V AC/minute

线性公差 / General Tolerance	
X	±0.2
X.X	±0.1
X.XX	±0.05
角度公差 / Angle Tolerance	
X°	±5.0°
X.X°	±3.0°
X.XX°	±1.0°

视角 / Projection



A1	调整平面		
标记	更改内容	签名	年月日
绘图			
审核			
工艺		批准	

材料 / Material

- ①塑座: LCP 本色
- ②接触针: 黄铜(镀锡)
- ③焊片: 黄铜(镀锡)

单位 (Units) 版本 比例

mm 2.0 1:1

共 1 张 第 1 张



品名 / ProduceName

PH2.0 立贴 9P

型号 / Model

BX-PH2.0-9PLT

X-ON Electronics

Largest Supplier of Electrical and Electronic Components

Click to view similar products for [Headers & Wire Housings](#) category:

Click to view products by [Bossie](#) manufacturer:

Other Similar products are found below :

[0015917161](#) [0022155065](#) [57102-F02-18ULF](#) [58102-G61-06LF](#) [582553-1](#) [01.001.5753.1](#) [0050291907](#) [02.125.8002.8](#) [609-3404](#) [61062-3](#)
[CSU011177004](#) [622-0430](#) [622-3653LF](#) [63453-116](#) [636-1030](#) [636-1427](#) [636-3427](#) [636-4007](#) [641938-9](#) [65495-038](#) [65692-001LF](#) [65781-018](#)
[65781-047](#) [65817-010LF](#) [65817-015LF](#) [67095-007LF](#) [67601157](#) [68631-112](#) [68645-018](#) [699319-000](#) [70.362.1628.0](#) [70-4210](#) [70-4226B](#) [70-](#)
[4853B](#) [71.350.2428.0](#) [733-134](#) [733-162](#) [760-3052](#) [MHR-64-VUAL](#) [80.063.4001.1](#) [800-90-001-10-001000](#) [801-43-002-10-013000](#)
[801-43-006-10-002000](#) [803-43-024-10-001000](#) [803-93-012-10-001000](#) [8-1437020-4](#) [819-22-004-30-001101](#) [820-22-006-30-001101](#)
[820-22-008-30-001101](#) [821-22-002-10-001101](#)