

RoHS

REV.	EC#	DESCRIPTION	DATE	DRAWING	CHECKED	APPROVED

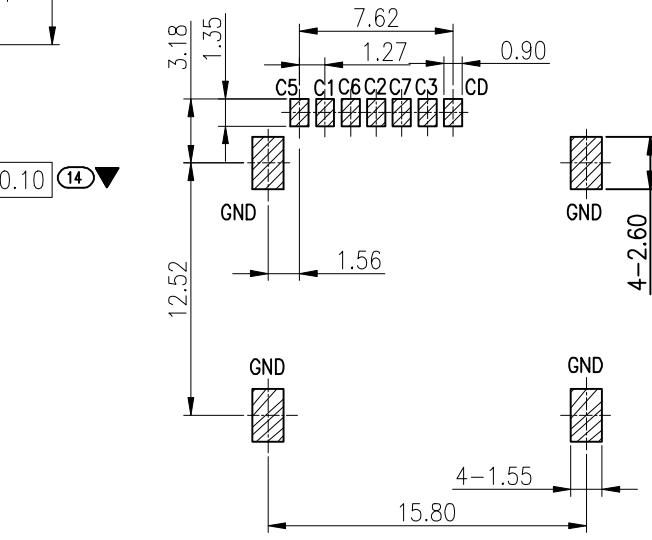
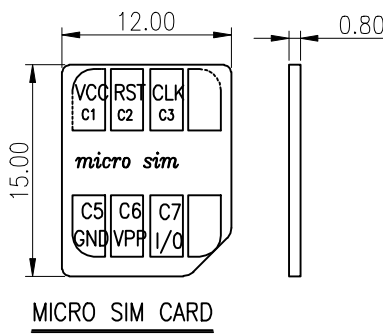
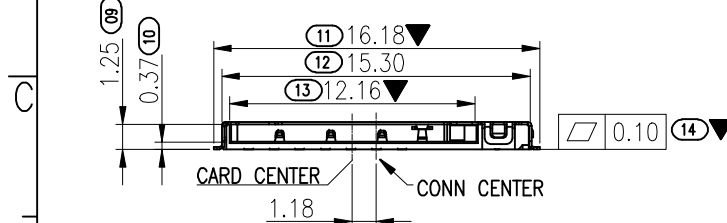
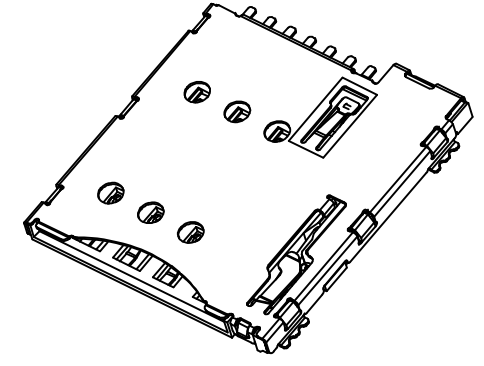
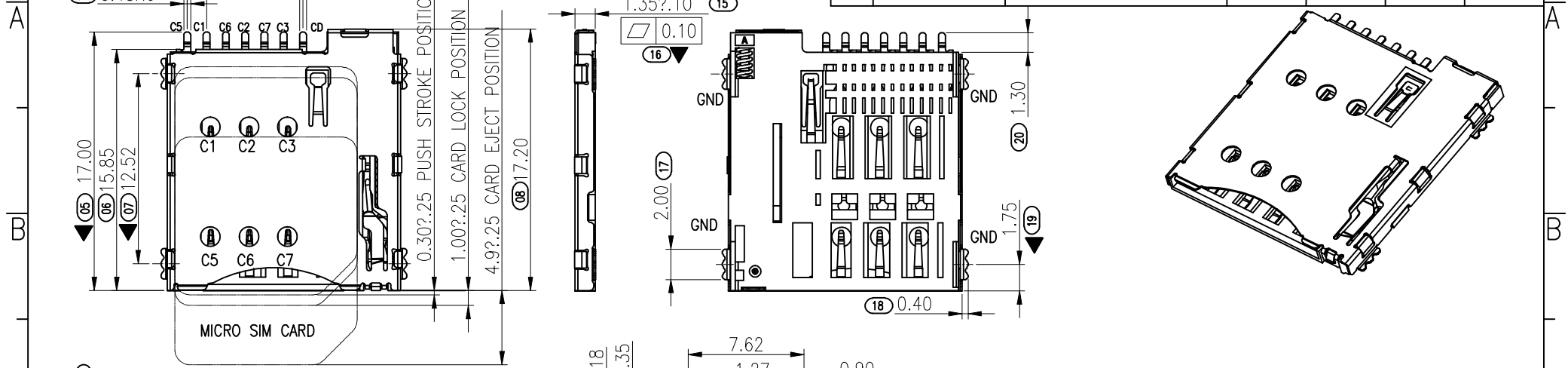

NOTES:
MATERIAL:
 Insulator: High Temperature Thermoplastic, UL 94V-0.
 Contact: Copper Alloy
 Shell: STAINLESS
PLATING:
 Contact: Plated 30u" Ni Overall ,Solder Area: Tin,Contact G/F
 Shell: Plated 30u" Ni Overall
 Plated G/F Selective Contact Area
Electrical:
 Current Rating :0.5mA max.
 Voltage Rating :50V DC MAX
 Ambient Temperature Range :-20°C~+85°C
 Storage Temperature Range :-40°C~+70°C
 Ambient Humidity Range :95% R.H. Max.
 Contact Resistance:100mΩ max.
 Insulation Resistance:1000MΩ min./250V DC
 Dielectric Withstanding Voltage:500V AC
 Mating Cycles:5,000 Insertions
 Temperature: 260°C ±5°

SIM pin Assignment	
PIN#	Name
C1	VCC
C2	RST
C3	CLK
C5	GND
C6	VPP
C7	I/O

■ CIRCUIT TRACE KEEP OUT AREA
 ■ SMT SOLDER AREA

THERE SHOULD NOT BE ANY CIRCUITRIES IN THE LAYOUT SPACE OF THE PRODUCTS.

RECOMMENDED PCB LAYOUT
 GENERAL TOLERANCE ±0.05

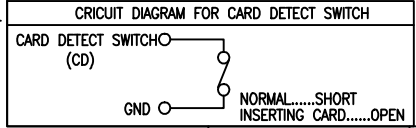

MILLIMETERS	INCH	UNITS	Bossie (博锡)			
X. ^o ± 2'	X. ^o ±	MM	PART NUMBER:		TITLE: 自弹式 MicroSIM卡座 7P	
.X ± 0.30	.XX ±	SEE NOTES	APPD:		DWG NO.: BX-SIM-1.35H7PJ-Z	
.XX ± 0.20	.XXX ±	FINISH	CHKD:		SCALE SHEET REV.	
.XXX± 0.10	.XXXX±	SEE NOTES	DR:		1:1 1/2 A0	
THESE DRAWINGS AND SPECIFICATIONS ARE THE PROPERTY OF Dong Guan Jin Bi Lai Electronic Co.,Ltd COPIED OR USED IN ANY MANNER WITHOUT THE PRIOR WRITTEN CONSENT OF Dong Guan Jin Bi Lai Electronic Co.,Ltd						

RoHS

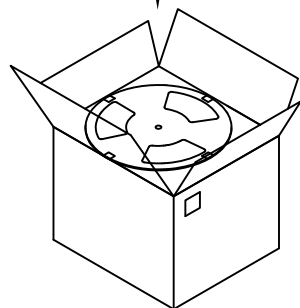
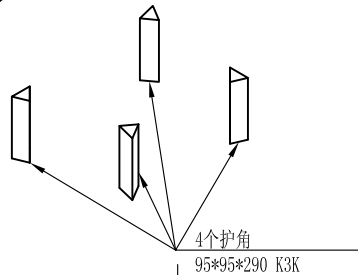
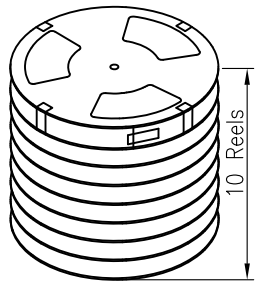
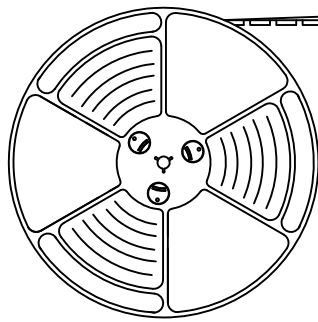
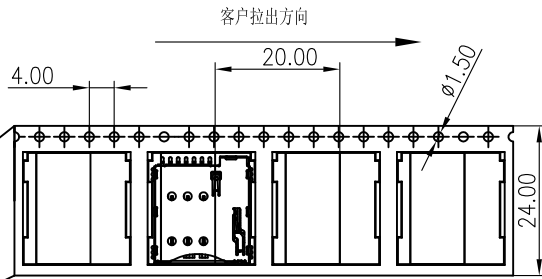

10 rolls per carton

NOTES

1. NUMBER OF CONNECTORS:1000PCS/REEL
2. LEAD TAPE LENGTH

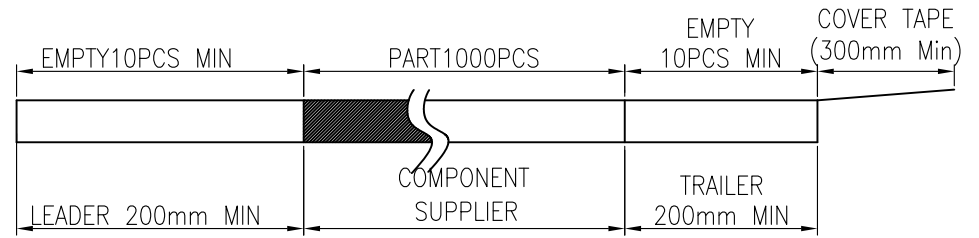

3. QUANTITY:10000PCS/CARTON

上下各1PCS珍珠棉

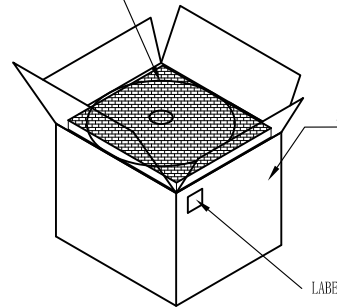

胶纸工字型封箱

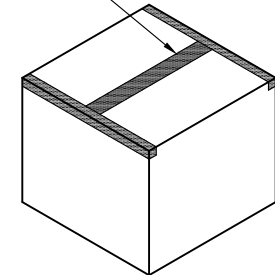

MILLIMETERS	INCH	UNITS	Bossie (博锡)		
X° ± 2°	X° ±	MM	PART NUMBER:		
.X ± 0.30	.XX ±	MAT'L			
.XX ± 0.20	.XXX ±	SEE NOTES	APPD:		
.XXX ± 0.10	.XXXX ±	FINISH			
THESE DRAWINGS AND SPECIFICATIONS ARE THE PROPERTY OF Dong Guan Jin Bi Lai Electronic Co.,Ltd			CHKD:		
COPIED OR USED IN ANY MANNER WITHOUT THE PRIOR WRITTEN CONSENT OF Dong Guan Jin Bi Lai Electronic Co.,Ltd					
QTY			SCALE	SHEET	REV.
SEE NOTES			1:1	2/2	A0

X-ON Electronics

Largest Supplier of Electrical and Electronic Components

Click to view similar products for [Memory Card Connectors](#) category:

Click to view products by [Bossie](#) manufacturer:

Other Similar products are found below :

[6407-249V-25273P](#) [6407-249V-25343P](#) [6426-201-21343](#) [69.920.0553.0](#) [MCR60A-98D-2.54DSA\(70\)](#) [809180410000000](#) [DM3AT-SF-PEJM5\(41\)](#) [IC11S-BUR-PNEJL\(71\)](#) [C70210M0083692](#) [2041353-2](#) [308-DS1P0811-192](#) [HM2P09PDR360N9LF](#) [10014744-011TLF](#) [11327-001](#) [11327-002](#) [NX1-32T-KT3K\(05\)](#) [95622-003LF](#) [84648-056HLF](#) [CCM03-3109 B LFT](#) [MS3116J10-6PW](#) [2309923-1](#) [61126-050CAHLF](#) [GTFP08432B1HR](#) [G85D1160022HHR](#) [SCE2MSDZN76A121SN](#) [10014744-011ALF](#) [10014744-011LF](#) [10057542-1211FLF](#) [10067972-000LF](#) [10067972-050LF](#) [10122302-20110LF](#) [G85D1162022HHR](#) [TF-05A](#) [M6014-12](#) [XKNANO-1412](#) [SMN-304-ARP6](#) [MIS11-S1F1-2000-A](#) [SMN-308-ARSP7](#) [MCS-302S-KT1B](#) [SMN-308-ACSP7](#) [K-DYX-008](#) [K-DYX-004](#) [C7024-03](#) [SMO-1030](#) [MCS-110-KT](#) [SIM-217](#) [SNO-1355-KT](#) [SMO-1025-P10](#) [SIM-211S-P6](#) [SNO-1440](#)