

REV.	DESCRIPTION	APPD	DATE
A/1	外壳弹片改直		
B/2	尺寸0.70改为0.55		
B/3	尺寸3.50改为2.30		
B/4	主体底部增加孔位		
C/1	增加CD PIN 高低管控		

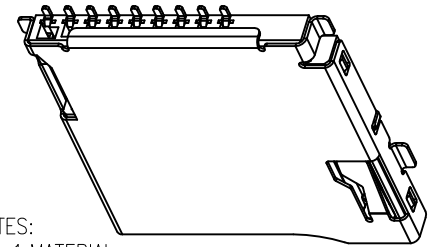

NOTES:
 1.MATERIAL:
 HOUSING: HIGH TEMPERATURE THERMOPLASTIC
 UL94V_0,COLOR:BLACK.
 CONTACT: COPPER ALLOYS.
 COVER: COPPER ALLOYS OR STEEL.
 2.PLATING:
 UNDERPLATE: NICKEL.
 CONTACT AREA: GOLD OVER NICKEL.
 SOLDER AREA: TIN OVER NICKEL.
 3.MULTIMEDIA CARD COMPATIBLE

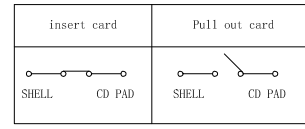

RECOMMENDED P.C.B HOLE LAYOUT
 COMPONENT SIDE VIEW(TOLERANCE: +/-0.05)

PART NO: BX-TF-1.8HJ		MATERIAL:			
LOT NO:		FINSH:			
UNIT: MM	SIZE: A4	COLOR:		TITLE: MicroSD卡(TF卡) 卡座	
TOLERANCES: X.X=±0.35 X.XX=±0.25 X.XXX=±0.15		GENERAL ANGLE: X.X=±3.0° X.XX=±2.0°		DR:	DWG NO:
		CHK:		APP:	SCALE: 1:1
					SHEET: 1 OF 3
					REV: E

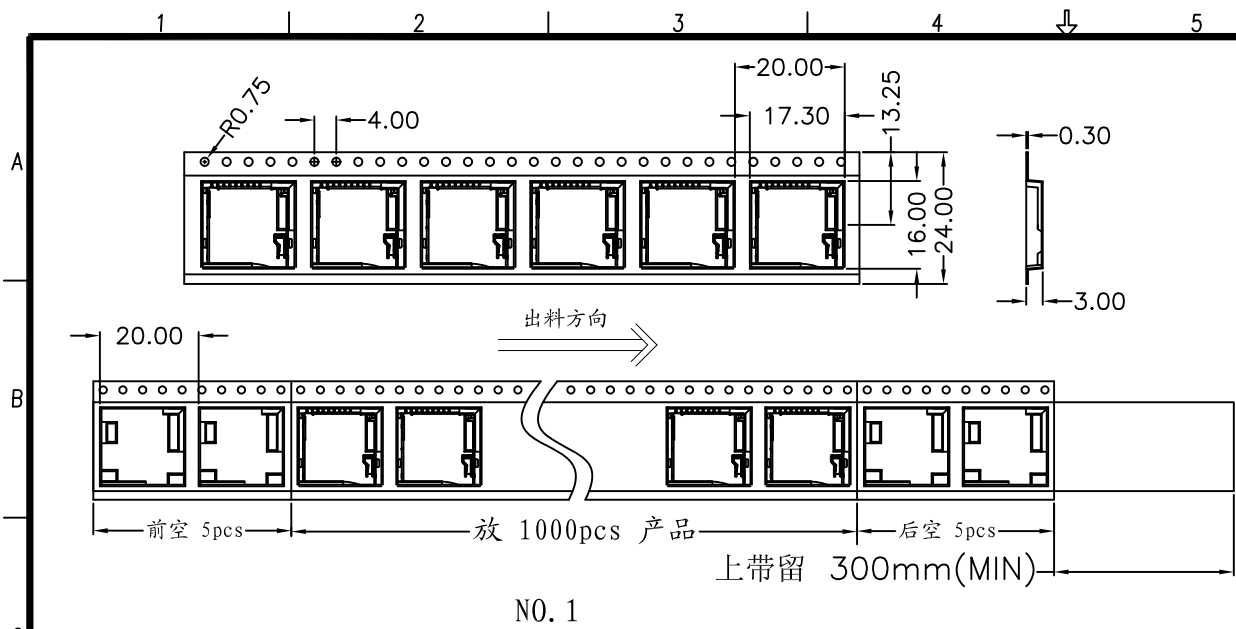

NO. 1

REV.	DESCRIPTION	APPD	DATE

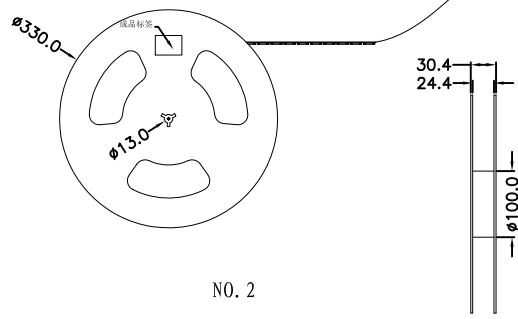

NO. 2

1. 材质要求:
- 1.1 纸箱的材质为K-K; 外形尺寸为34*34*38.5;
 - 1.2 卷盘的材质为PS, 卷盘的外形尺寸为 $\phi 330 \times 30.4$;
 - 1.3 卷带的材质为PS, 卷带的外形尺寸为20200*24.00*3.0mm;
2. 包装方式:
- 2.1 将卷带放入包装机后, 前空5PCS, 后放产品1000PCS, 再后空5PCS; 上带留300MM长度。
 - 2.2 将包装好的产品从包装机上取下并包装好, 贴上内盘标签;
 - 2.3 把累叠好的12盘叠放入纸箱中共计12Kset, 上下放纸板, 纸箱四个角塞护角纸;
 - 2.4 把包装好的成品打包封箱, 并在纸箱外贴上标签

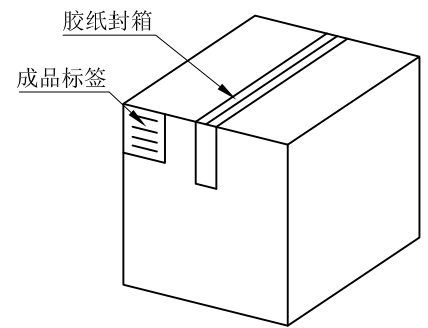

纸箱规格: 340*340*385

NO. 4

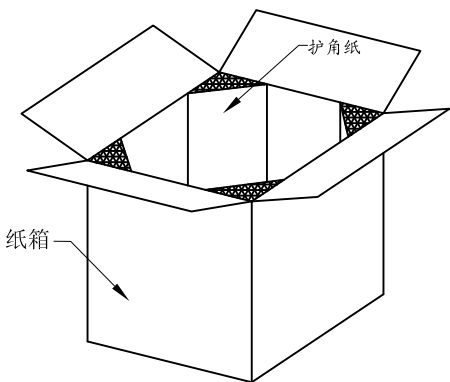
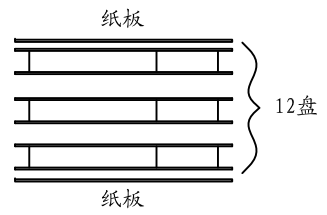

NO. 3

PART NO: BX-TF-1.8HJ		MATERIAL:			
LOT NO:		FINSH:			
UNIT: MM	SIZE: A4	COLOR:		TITLE:	
TOLERANCES: X.X=±0.35 X.XX=±0.25 X.XXX=±0.15		GENERAL ANGLE: X.X=±3.0° X.XX=±2.0°		DR:	
		CHK:		DWG NO:	
		APP:		SCALE: 1:1	
				SHEET: 3 OF 3	
				REV: B/3	

Bossie (博锡)

Mi croSD卡(TF卡) 卡座

X-ON Electronics

Largest Supplier of Electrical and Electronic Components

Click to view similar products for [Memory Card Connectors](#) category:

Click to view products by [Bossie](#) manufacturer:

Other Similar products are found below :

[6407-249V-25273P](#) [6407-249V-25343P](#) [6426-201-21343](#) [69.920.0553.0](#) [MCR60A-98D-2.54DSA\(70\)](#) [809180410000000](#) [DM3AT-SF-PEJM5\(41\)](#) [IC11S-BUR-PNEJL\(71\)](#) [C70210M0083692](#) [2041353-2](#) [308-DS1P0811-192](#) [HM2P09PDR360N9LF](#) [10014744-011TLF](#) [11327-001](#) [11327-002](#) [NX1-32T-KT3K\(05\)](#) [95622-003LF](#) [84648-056HLF](#) [CCM03-3109 B LFT](#) [MS3116J10-6PW](#) [2309923-1](#) [61126-050CAHLF](#) [GTFP08432B1HR](#) [G85D1160022HHR](#) [SCE2MSDZN76A121SN](#) [10014744-011ALF](#) [10014744-011LF](#) [10057542-1211FLF](#) [10067972-000LF](#) [10067972-050LF](#) [10122302-20110LF](#) [G85D1162022HHR](#) [TF-05A](#) [M6014-12](#) [XKNANO-1412](#) [SMN-304-ARP6](#) [MIS11-S1F1-2000-A](#) [SMN-308-ARSP7](#) [MCS-302S-KT1B](#) [SMN-308-ACSP7](#) [K-DYX-008](#) [K-DYX-004](#) [C7024-03](#) [SMO-1030](#) [MCS-110-KT](#) [SIM-217](#) [SNO-1355-KT](#) [SMO-1025-P10](#) [SIM-211S-P6](#) [SNO-1440](#)