

SPECIFICATIONS:

1. ELECTRICAL CHARACTERISTICS:

- 1-1. CONTACT RESISTANCE: 30mΩ MAX.
- 1-2. DIELECTRIC WITHSTANDING VOLTAGE: 100V AC FOR ONE MINUTE.
- 1-3. INSULATION RESISTANCE: 100MΩ MIN. MEASURED BY 500 VDC

2. MECHANICAL CHARACTERISTICS:

- 2-1. INSERTION FORCE :0.5-2.0KgF(REF.)
- 2-2. WITHDRAWAL FORCE :0.8-2.0KgF(REF.)

3. LIFE TEST: 10,000 CYCLES.

4. TO CONFORM TO THE KRCONN HAZARDOUS SUBSTANCE FREE SPEC.

REV.	ECN NO OR DESCRIPTION	REVISED	DATE
A	PROPOSE ONLY		

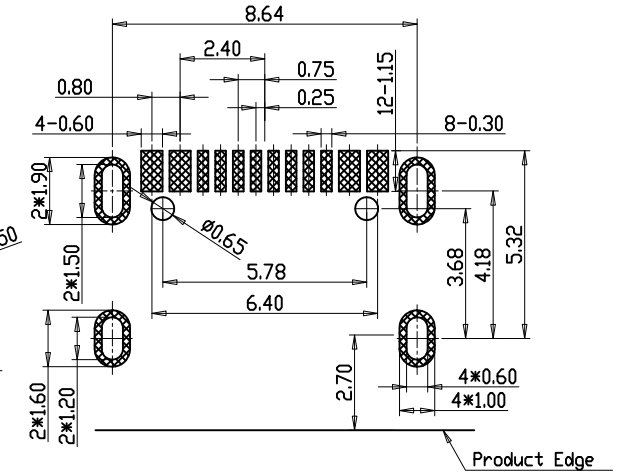
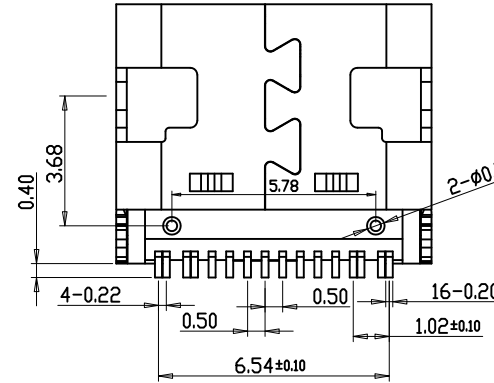
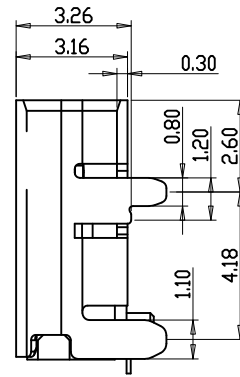
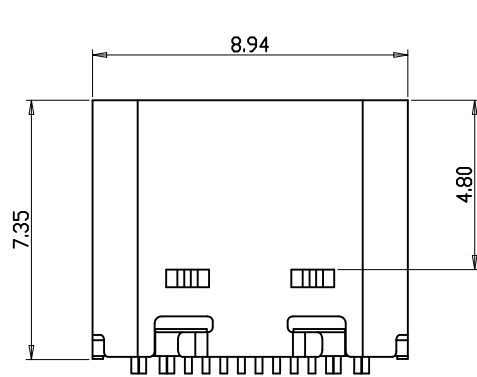
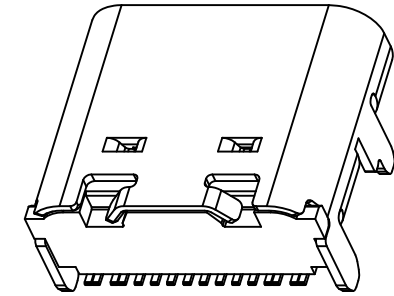

*RECOMMENDED P.C.B. LAYOUT (T:1.00mm)
TOLERANCE UNSPECIFIED ±0.05mm*

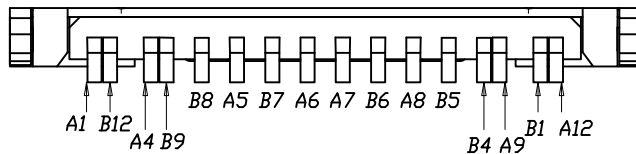
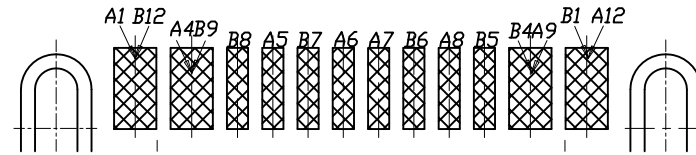
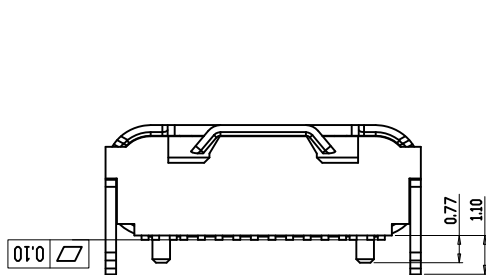

A1	GND	B12	GND
A4	VBUS	B9	VBUS
A5	CC1	B8	SBU2
A6	DP1	B7	DN2
A7	DN1	B6	DP2
A8	SBU1	B5	CC2
A9	VBUS	B4	VBUS
A12	GND	B1	GND
PIN			

6	SHELL	STAINLESS STEEL	Ni Plated	1PCS
5	SHIELDING PLATE	STAINLESS STEEL	---	1PCS
4	MD	HIGH TEMPERATURE PLASTIC	BLACK	1PCS
3	CONTACT	COPPER ALLOY	Au/Ni Plated	1SET
2	CONTACT	COPPER ALLOY	Au/Ni Plated	1SET
1	HOUSING	HIGH TEMPERATURE PLASTIC	BLACK	1PCS
NO.	DESCRIPTION	MATERIAL	REMARKS	QTY

UNLESS OTHERWISE SPECIFIED TOLERANCES		JB Bossie (博锡)			
DECIMALS:		ANGLES:		TITLE	
X	±0.5	X	±2°	DWN	Type-C 母座卧贴
X.X	±0.20	X.X	±1°	CHKD	BX-TYPE-C-B-MWT16P
X.XX	±0.10			APVD	SCALE:1:1 UNIT: mm
				SHEET:10F1	REV: A
CUSTOMER COPY					

X-ON Electronics

Largest Supplier of Electrical and Electronic Components

Click to view similar products for [USB Connectors](#) category:

Click to view products by [Bossie](#) manufacturer:

Other Similar products are found below :

[950](#) [MUSBD11135](#) [17-200721](#) [217450-1](#) [KMBVX-TH-5S-B30](#) [KUSBX-AS2N-W](#) [KUSBX-SMT2AP1S-W30](#) [935](#) [957](#) [30-498-6](#) [SK-60A-2](#)
[1734082-1](#) [30-470](#) [30-489](#) [30-541](#) [A-USB A-2P-C](#) [MIKROE-1451](#) [USBFTVSCCG](#) [1-1734084-2](#) [10135326-001LF](#) [4198](#) [USB-A-D-VT](#)
[USB-A-S-RA-TSMT](#) [1310-1023-02](#) [690-024-633-031](#) [UB-20PMFP-LC7001](#) [17-200011](#) [UB-20AFMM-LL7A01](#) [1040870124](#) [CAP-](#)
[WCCMLPB1](#) [CAP-WCCMLPC1](#) [2274475-3](#) [UB-20BMFA-SL8001](#) [914-614A2025S10200](#) [USB3FTV7SAGF059](#) [ZX40-B-5S-1500-](#)
[STDA\(30\)](#) [GSB3116344HR](#) [USB3FTV2SAZNF459](#) [USB3FTV7SAZNF459](#) [U221-041N-1WVS62-F5D](#) [HYCW153-USBD05-500B](#)
[HYCW219-USBD05-075B](#) [HYCW148-USBD05-117B](#) [HYCW149-USBD05-740B](#) [HYCW204-USBD05-108B](#) [HYCW214-USBA04-113B](#)
[HYCW213-USBA04-113B](#) [UB-20AMFM-SL7A01](#) [KMMX-BSMT35S-1-B30TR](#) [2345986-1](#)