

RoHS

REV. ECN.NO. APPD.

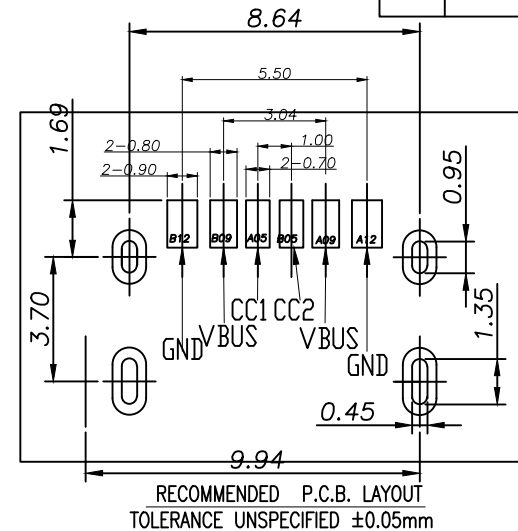
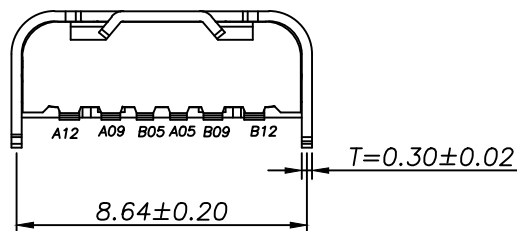
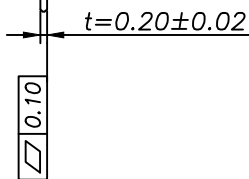
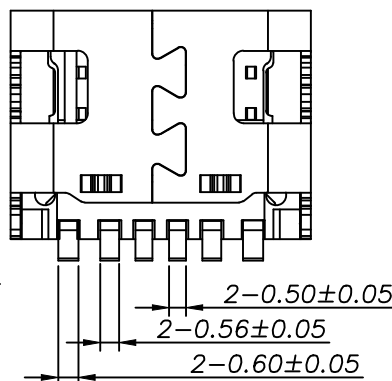
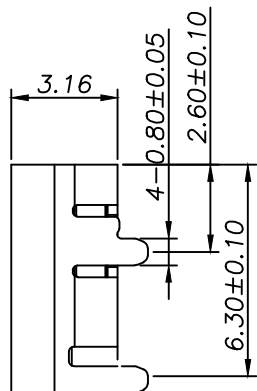
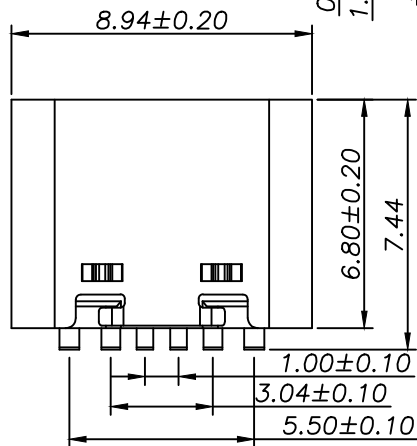
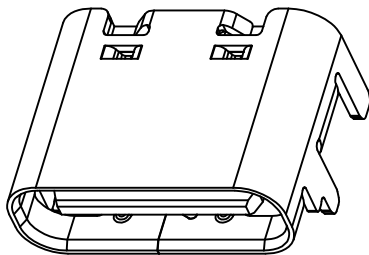
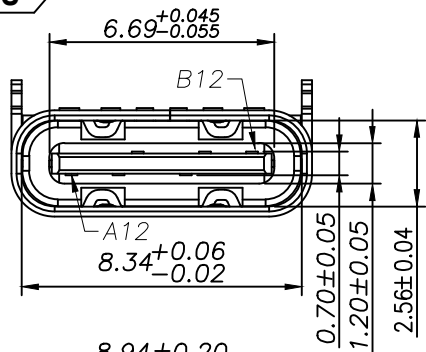

- NOTES:
- MATERIAL:
 - MOLDING: LCP UL94 V-0
 - CONTACT: COPPER ALLOY.
 - GOLD PLATED Min ON CONTACT AREA, 100u"
 - Min TIN (LEAD FREE) ON SOLDER AREA,
 - SHELL: SUS304-H, T=0.30±0.03mm
 - 50u" NICKEL PLATING OVER ALL.
 - MECHANICAL:
 - INSERTION: 5~20N.
 - EXTRACTION: 8~20N AFTER TEST.
 - DURABILITY: 10000 CYCLES
 - ELECTRICAL:
 - CURRENT: 5A FOR VBUS;
 - 1.25A FOR GND PIN.
 - 0.25A FOR OTHER.
 - VOLTAGE: 20 V MAX
 - WITHSTANDING VOLTAGE: 100V AC R.M.S.
 - CONTACT RESISTANCE: 40mΩ MAX.
 - INSULATION RESISTANCE: 100MΩ MIN.
 - ENVIRONMENTAL
 - TEMPERATURE RANGE -25°C ~ +85°C

TABLE :

料号	REMARKS
ZX-TYPEC-WTM648	接触区金 G/F 锡脚
	接触区金 3u 锡脚

A1&B12	GND	C1
A4&B9	VBUS	C2
A5	CC1	C3
B5	CC2	C4
A9&B4	VBUS	C5
A12&B1	GND	C6
PIN	SIGNAL NAME	PCB PAD NO

NO.	DESCRIPTION	MATERIAL	REMARKS	QTY
4	SHELL	STAINLESS STEEL SUS201	Ni/SN Plated	1PCS
3	MID PLATE	STAINLESS STEEL SUS304	---	1PCS
2	CONTACT	COPPER ALLOY C2680 EH	C2680 EH (SEE TABLE)/NI50U"/SN 80U" Plated	1SET
1	HOUSING	HIGH TEMPERATURE PLASTIC	BLACK	1PCS

TOLERANCE UNLESS OTHERWISE SPECIFIED	
.XXX ±0.10	.X' ±3'
.XX ±0.20	.XX' ±2'
.X ±0.30	

JB Bossie (博锡)

APPROVED		PART NAME:	Type-C			
CHECKED		PART No:	BX-TYPE-C-MWT6P			C
DRAWN		PROJECTION:	UNIT:	SCALE:	SHEET:	REV.
DATE			mm	1:1	1 OF 1	A

X-ON Electronics

Largest Supplier of Electrical and Electronic Components

Click to view similar products for [USB Connectors](#) category:

Click to view products by [Bossie](#) manufacturer:

Other Similar products are found below :

[950](#) [MUSBD11135](#) [17-200721](#) [217450-1](#) [KMBVX-TH-5S-B30](#) [KUSBX-AS2N-W](#) [KUSBX-SMT2AP1S-W30](#) [935](#) [957](#) [30-498-6](#) [SK-60A-2](#)
[1734082-1](#) [30-470](#) [30-489](#) [30-541](#) [A-USB A-2P-C](#) [MIKROE-1451](#) [USBFTVSCCG](#) [1-1734084-2](#) [10135326-001LF](#) [4198](#) [USB-A-D-VT](#)
[USB-A-S-RA-TSMT](#) [1310-1023-02](#) [690-024-633-031](#) [UB-20PMFP-LC7001](#) [17-200011](#) [UB-20AFMM-LL7A01](#) [1040870124](#) [CAP-](#)
[WCCMLPB1](#) [CAP-WCCMLPC1](#) [2274475-3](#) [UB-20BMFA-SL8001](#) [914-614A2025S10200](#) [USB3FTV7SAGF059](#) [ZX40-B-5S-1500-](#)
[STDA\(30\)](#) [GSB3116344HR](#) [USB3FTV2SAZNF459](#) [USB3FTV7SAZNF459](#) [U221-041N-1WVS62-F5D](#) [HYCW153-USBD05-500B](#)
[HYCW219-USBD05-075B](#) [HYCW148-USBD05-117B](#) [HYCW149-USBD05-740B](#) [HYCW204-USBD05-108B](#) [HYCW214-USBA04-113B](#)
[HYCW213-USBA04-113B](#) [UB-20AMFM-SL7A01](#) [KMMX-BSMT35S-1-B30TR](#) [2345986-1](#)