

## Features

- Compact SMD package
- Input / Output Isolation Voltage: 1.5kVDC
- High Efficiency
- Lead Free Design, RoHS Compliant
- Operating temperature: -40°C to +105°C
- Continuous Short -Circuit Protection
- Meet Safety Standard / Approval: IEC / EN60950-1

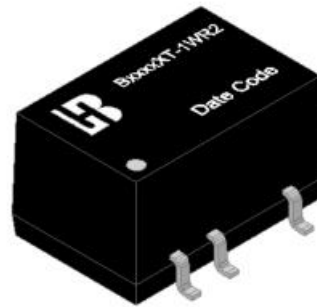

## Applications

These converters are well suitable for battery operated equipment, measurement equipment, telecom, wireless network, Industry control system, everywhere where isolated, tightly regulated voltages and compact size are required.

**Technical Specification** All specifications are typical at nominal input, full load and 25°C unless otherwise stated.

| Model Number | Input Voltage Range(V)   | Output Voltage (V) | Output Current (mA) <sup>(1)</sup><br>Full Load | Input Current (mA) Typ. |           | Eff. (%) <sup>(2)</sup><br>Typ. | Capacitive Load, max. <sup>(3)</sup> (uF) |
|--------------|--------------------------|--------------------|---|-------------------------|-----------|---------------------------------|---|
|              |                          |                    |   | No Load                 | Full Load |                                 |   |
| B0305XT-1WR2 | 2.97-3.63<br>Nominal:3.3 | 3.3                | 300   | 35                      | 405       | 74                              | 68  |
| B0305XT-1WR2 |                          | 5                  | 200   |                         | 404       | 75                              | 47  |
| B0503XT-1WR2 | 4.5-5.5<br>Nominal:5     | 3.3                | 300   | 28                      | 264       | 75                              | 68  |
| B0505XT-1WR2 |                          | 5                  | 200   |                         | 260       | 77                              | 47  |
| B0509XT-1WR2 |                          | 9                  | 110   |                         | 248       | 80                              | 33  |
| B0512XT-1WR2 |                          | 12                 | 83  |                         | 247       | 81                              | 22  |
| B0515XT-1WR2 |                          | 15                 | 67  |                         | 247       | 81                              | 22  |
| B1203XT-1WR2 | 10.8-13.2<br>Nominal:12  | 3.3                | 300   | 17                      | 109       | 76                              | 68  |
| B1205XT-1WR2 |                          | 5                  | 200   |                         | 107       | 78                              | 47  |
| B1209XT-1WR2 |                          | 9                  | 110   |                         | 107       | 78                              | 33  |
| B1212XT-1WR2 |                          | 12                 | 83  |                         | 104       | 80                              | 22  |

| Input Specifications               |                               |                                |
|------------------------------------|-------------------------------|--------------------------------|
|                                    | 3.3V nominal input            | 2.97-3.63V                     |
|                                    | 5V nominal input              | 4.5-5.5V                       |
|                                    | 12V nominal input             | 10.8-13.2V                     |
|                                    | 15V nominal input             | 13.5-16.5V                     |
| Input filter                       |                               | Capacitor                      |
| Environmental Specifications       |                               |                                |
| Operating ambient temperature      |                               | -40°C to +105°C                |
| Maximum case temperature           |                               | +125°C                         |
| Storage temperature range          |                               | -55°C to +125°C                |
| Relative humidity                  |                               | 95% RH max.                    |
| Output Specifications              |                               |                                |
| Output power                       |                               | 1Watts max.                    |
| Voltage accuracy                   | Nominal Vin and full load     |                                |
|                                    | 3.3Vdc                        | 3.135-3.399V                   |
|                                    | 5Vdc                          | 4.75-5.15V                     |
|                                    | 9Vdc                          | 8.73-9.18V                     |
|                                    | 12Vdc                         | 11.64-12.24V                   |
|                                    | 15Vdc                         | 14.55-15.30V                   |
| Minimum load                       |                               | 10% load of full load          |
| Line regulation                    | For Vin change of 1%          | ±1.2% Typ.                     |
|                                    | Nominal Vin and 10%-100% load |                                |
| Load regulation                    | 3.3Vdc                        | 15% Typ.                       |
|                                    | 5Vdc                          | 13% Typ.                       |
|                                    | 9Vdc                          | 9% Typ.                        |
|                                    | 12Vdc                         | 8% Typ.                        |
|                                    | 15Vdc                         | 7% Typ.                        |
| Ripple and Noise (20MHz Bandwidth) |                               | 50mVp-p Typ.<br>100mVp-p Max.  |
| Maximum capacitive load            |                               | See table                      |
| Output short circuit protection    | B03xxXT-1WR2                  | 3S Max.                        |
|                                    | Other models                  | Continuous, Automatic recovery |
| Temperature coefficient            |                               | ±0.03%/°C Typ.                 |
| General Specifications             |                               |                                |
| Efficiency                         | Nominal input and full load   | See table                      |
| Isolation voltage                  | Input to output               | 1500VDC (60 second)            |
| Isolation resistance               | 500VDC                        | 1000MΩ min.                    |
| Isolation capacitance              |                               | 30pF typ.                      |
| Switching frequency                |                               | 150kHz typ.                    |
|                                    |                               | 300kHz max.                    |
| Reliability, calculated MTBF       |                               | 2×10 <sup>6</sup> Hrs          |

## Physical Specifications

|                  |                    |
|------------------|--------------------|
| Case material    | Plastic (UL94 V-0) |
| Potting material | PU (UL94 V-0)      |
| Dimensions       | 19.6× 10.1× 6.0 mm |
| Weight           | 1.4g Typ.          |

### Note

1. Io below this value will not damage these converters, however, they may not meet all listed specifications.
2. Typical value, tested at nominal input and full load.
3. In case of long input lines or hot plug-in requirements, we recommended to use an external low ESR capacitor (22uF) near to the converter's input pins.
4. Specifications subject to change without notice.

## Power Derating Curve

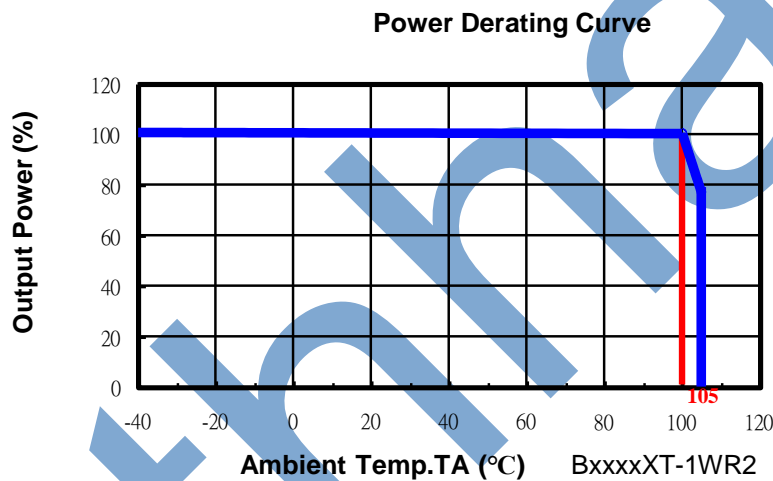

## Mechanical Dimensions

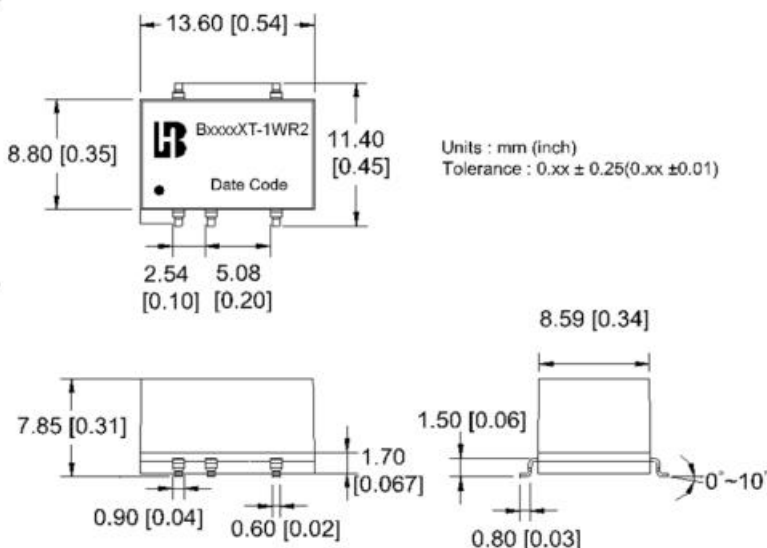

| Pin | 1.5KVdc - Single |        | Pin |
|-----|------------------|--------|-----|
| 1   | -Vin             | NC     | 14  |
| 3   | +Vin             | ---    | 12  |
| 5   | ---              | ---    | 10  |
| 7   | Vo (-)           | Vo (+) | 8   |

Unit: mm (inch)  
Tolerance: 0.XX ± 0.25 (0.XX ± 0.01)

## Test Configurations

All specifications are typical at nominal input, full load and 25°C unless otherwise stated.

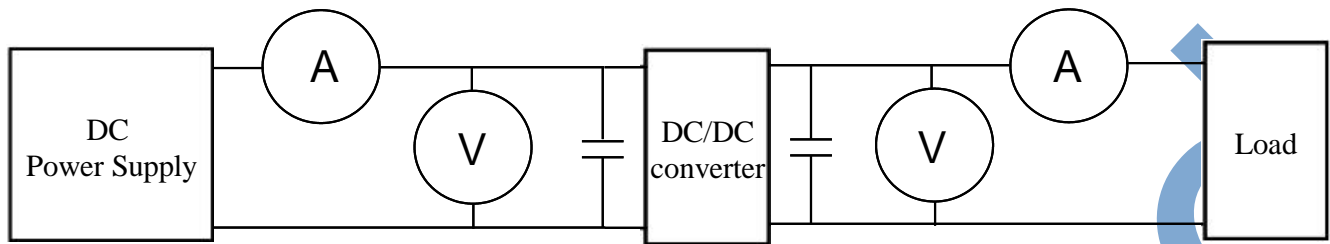

⊙DC Power Supply: It offers a wide voltage and current range precisely.

⊙Current meter (A): Accuracy → 200μA ~ 200mA 4 ranges ±(0.2% rdg + 2 digits)  
2000mA ~ 20A 2 ranges ±(0.3% rdg + 2 digits).

⊙Voltage meter (V): Accuracy → ±(0.03% rdg + 4 digits).

⊙Load: At full load.

⊙Wires: The resistance of the wires must be small.

1. Input voltage range: Narrow input voltage range (±10%) · wide input voltage range (2:1 and 4:1) ◦

EX: Narrow input voltage range (±10%)

5V nominal input → 4.5~5.5V  
12V nominal input → 10.8~13.2V  
24V nominal input → 21.6~26.4V

Wide input voltage range 2:1

5V nominal input → 4.5~9V  
12V nominal input → 9~18V  
24V nominal input → 18~36V  
48V nominal input → 36~75V

Wide input voltage range 4:1 (W)

24V nominal input → 9~36V  
48V nominal input → 18~75V

2. Input power :

$$P_{in} = V_{in} \times I_{in}$$

$V_{in}$  : Input voltage  
 $I_{in}$  : Input current

3. Output power :

$$P_{out} = V_{out} \times I_{out}$$

$V_{out}$  : Output voltage  
 $I_{out}$  : Output current

4. Efficiency :

$$\text{Efficiency} = \frac{P_{out}}{P_{in}} \times 100\%$$

$P_{out}$ : Output power  
 $P_{in}$ : Input power

5. Voltage accuracy:

$$\frac{|V_{out} - V_{out(nominal)}|}{V_{out}} \times 100\%$$

$V_{out}$  : Output voltage  
 $V_{out(nominal)}$  : Nominal output voltage

### 6. Line regulation:

Narrow input voltage range ( $\pm 10\%$ ) and unregulated output voltage series.

$$\text{Line regulation} = \frac{\Delta V_{out}}{\Delta V_{in}}$$

$$\Delta V_{out} = \frac{V_{out(+10\%)} - V_{out(-10\%)}}{V_{out}} \times 100\%$$

$V_{out(+10\%)}$  : Output voltage at  $V_{in} = 1.1 \times V_{in}(\text{nominal})$  & full load

$V_{out(-10\%)}$  : Output voltage at  $V_{in} = 0.9 \times V_{in}(\text{nominal})$  & full load

$V_{out}$  : Output voltage at  $V_{in} = V_{in}(\text{nominal})$  & full load

$$\Delta V_{in} = \frac{V_{in(+10\%)} - V_{in(-10\%)}}{V_{in}(\text{nominal})} \times 100\%$$

$V_{in(+10\%)}$  : Input voltage =  $1.1 \times V_{in}(\text{nominal})$

$V_{in(-10\%)}$  : Input voltage =  $0.9 \times V_{in}(\text{nominal})$

$V_{in}(\text{nominal})$  : Nominal Input voltage

### 7. Load regulation :

$$\frac{|V_{out(FL)} - V_{out(NL)}|}{V_{out(FL)}} \times 100\%$$

$V_{out(FL)}$ : Output voltage at full load

$V_{out(NL)}$ : Output voltage at 10% full load

### 8. Ripple and Noise: as shown below. The bandwidth is 0-20MHz.

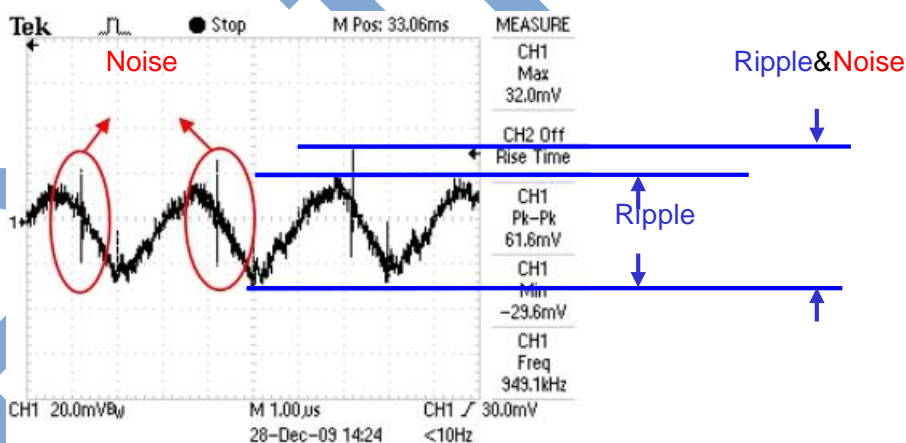

Output Ripple&Noise measurement test circuit: as shown below.

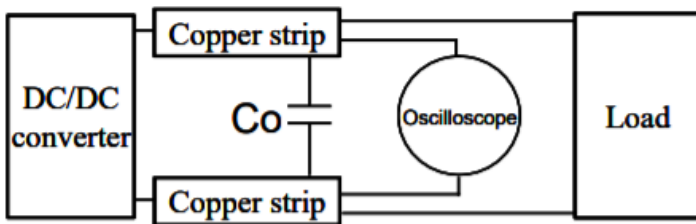

Co: usually 0.47uF.

9. Temperature derating curve: The DC-DC converter will operate over a wider temperature range if less power is drawn from the output and the device is already running. The temperature derating curve shows the operating power-temperature range. As shown below.

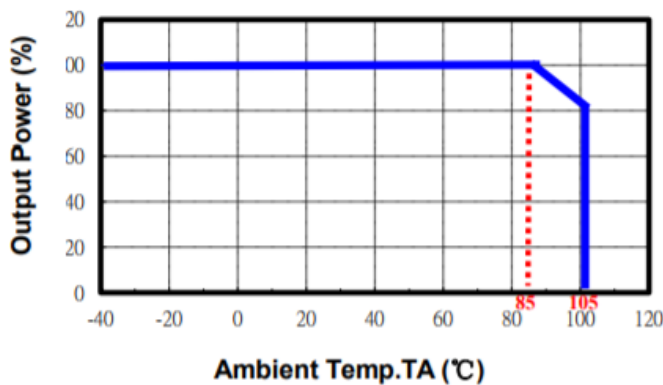

10. Switching frequency: The nominal operating frequency of the DC-DC converters.
11. Input to output isolation: The dielectric breakdown strength test between input and output circuits. This is the isolation voltage the device is capable of withstanding for a specified time, usually 1 second or 1 minute.
12. Input source impedance: The power module should be connected to low ac-impedance input source. Highly inductive source impedances can affect the stability of the power module. In applications where power is supplied over long lines and output loading is high, it may be necessary to use a capacitor at the input to ensure startup. Capacitor mounted close to the power module helps ensure stability of the unit, it is commended to use a good quality low Equivalent Series Resistance (ESR <math>< 0.1\Omega</math> at 100KHz) capacitor of a 22uF for the power module.

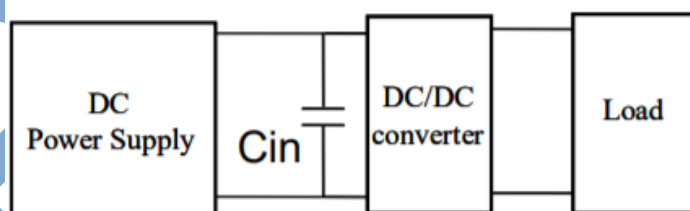

## X-ON Electronics

Largest Supplier of Electrical and Electronic Components

*Click to view similar products for [Power Management Modules](#) category:*

*Click to view products by [Bothhand](#) manufacturer:*

Other Similar products are found below :

[FPF1C2P5BF07A](#) [FPF1C2P5MF07AM](#) [FH2000NPBAP](#) [B0505S-2W](#) [HLK-5D1205](#) [HLK-10D4805B](#) [B0505XT-1WR2-R](#) [B0505S-1W](#)  
[B1224S-1WR2](#) [AP24N20-HV](#) [TAS25-24-W](#) [TAS10-5-W](#) [TAS10-24-W](#) [TAD10-1505-NI](#) [LS03-13B09R3](#) [HCES1-05D12](#) [HCS2-12D15](#)  
[DC2626A](#) [DFR0756](#) [CS-POWEEVER-02](#) [CS-POWEEVER-01](#) [01D-6R5-2A](#) [11D-05S05NANL](#) [12D-03S05N3KVAC](#) [12D-](#)  
[05S05N3WNL](#) [12D-05S05RNL](#) [12D-24S05R2W](#) [12DA-05S05N2W](#) [13D-05S05NCNL](#) [13DS1-12D09NNL](#) [13DSB-05S05N1.5KV](#) [14D-](#)  
[12S03R1KVNL](#) [14DB-05S05N1.5KV](#) [14DZ-05S05R2W](#) [MEE1S0309SC](#) [22D-12D12NCNL](#) [EN5322QI](#) [LTM4624EY#PBF](#) [1SP0340V2M0-](#)  
[45](#) [IGD515EI](#) [1SP0335D2S1-5SNA0750G650300](#) [2SP0115T2A0-FF600R12ME4](#) [2SP0115T2A0-12](#) [2SD106AI-17](#) [UL](#) [2SC0635T2A1-45](#)  
[2SC0115T2A0-12](#) [2SC0108T2F1-17](#) [1SD210F2-MBN1200H45E2-H\\_Opt1](#) [A0505S-1W](#) [A0505S-1WR2](#)