

Features

- 7pin SIP Package with Industry-Standard Footprint
- Input / Output Isolation Voltage: 1.5kVDC
- High Efficiency
- Lead Free Design, RoHS Compliant
- Operating temperature: -40°C to +105°C
- Meet Safety Standard / Approval: IEC / EN60950-1

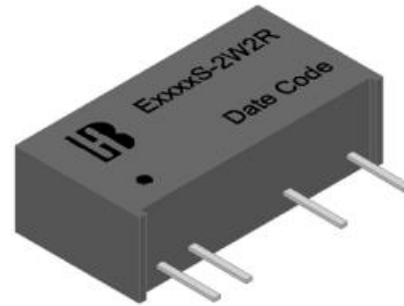

Applications

These converters are well suitable for battery operated equipment, measurement equipment, telecom, wireless network, Industry control system, everywhere where isolated, tightly regulated voltages and compact size are required.

Technical Specification All specifications are typical at nominal input, full load and 25°C unless otherwise stated.

Model Number	Input Voltage Range(V)	Output Voltage (V)	Output Current (mA) (1) Full Load	Input Current (mA) Typ.		Eff. (%) (2) Typ.	Capacitive Load, max. (3) (uF)
				No Load	Full Load		
E0503S-2WR2	4.5-5.5 Nominal:5	±3.3	±300	35	525	78	68
E0505S-2WR2		±5	±200		500	80	22/22
E0509S-2WR2		±9	±110		477	83	10/10
E0512S-2WR2		±12	±83		475	84	10/10
E0515S-2WR2		±15	±66		475	84	10/10
E0524S-2WR2		±24	±42		475	84	4.7/4.7
E1203S-2WR2	10.8-13.2 Nominal:12	±3.3	±200	15	143	77	33/33
E1205S-2WR2		±5	±200		208	80	22/22
E1209S-2WR2		±9	±110		199	83	10/10
E1212S-2WR2		±12	±83		198	84	10/10
E1215S-2WR2		±15	±66		198	84	10/10

Model Number	Input Voltage Range(V)	Output Voltage (V)	Output Current (mA) (1) Full Load	Input Current (mA) Typ.		Eff. (%) (2) Typ.	Capacitive Load, max. (3) (uF)
				No Load	Full Load		
E1503S-2WR2	13.5-16.5 Nominal:15	±3.3	±200	12	114	77	33/33
E1505S-2WR2		±5	±200		167	80	22/22
E1509S-2WR2		±9	±110		159	83	10/10
E1512S-2WR2		±12	±83		158	84	10/10
E1515S-2WR2		±15	±66		158	84	10/10
E2403S-2WR2	21.6-26.4 Nominal:24	±3.3	±200	8	71	77	33/33
E2405S-2WR2		±5	±200		104	80	22/22
E2409S-2WR2		±9	±110		99	83	10/10
E2412S-2WR2		±12	±83		99	84	10/10
E2415S-2WR2		±15	±66		99	84	10/10

Input Specifications

	5V nominal input	4.5-5.5V
	12V nominal input	10.8-13.2V
	15V nominal input	13.5-16.5V
	24V nominal input	21.6-26.4V

Input filter	Capacitor	
--------------	-----------	--

Environmental Specifications

Operating ambient temperature	-40°C to +105°C	
Maximum case temperature	+125°C	
Storage temperature range	-55°C to +125°C	
Relative humidity	95% RH max.	

Output Specifications

Output power	2Watts max.	
--------------	-------------	--

Voltage accuracy	Nominal Vin and full load	
	3.3Vdc	3.135-3.399V
	5Vdc	4.75-5.15V
	9Vdc	8.73-9.18V
	12Vdc	11.64-12.24V
	15Vdc	14.55-15.30V
	24Vdc	23.52-24.36V
25Vdc	24.50-25.37V	

Voltage balance	Dual output	±1% max.
-----------------	-------------	----------

Minimum load	10% load of full load	
--------------	-----------------------	--

Line regulation	For Vin change of 1%	±1.2% Typ.
-----------------	----------------------	------------

Load regulation	Nominal Vin and 10%-100% load	
	3.3Vdc	15% Typ.
	5Vdc	13% Typ.
	9Vdc	9% Typ.
	12Vdc	8% Typ.
	15Vdc	7% Typ.
	24Vdc	6% Typ.
25Vdc	6% Typ.	

Ripple and Noise (20MHz Bandwidth)	100mVp-p Typ. 150mVp-p Max.	
------------------------------------	--------------------------------	--

Maximum capacitive load	See table	
-------------------------	-----------	--

Output short circuit protection	E24xxxxS-2WR2	3S Max.
	Other models	Continuous, Automatic recovery

Temperature coefficient	±0.03%/°C Typ.	
General Specifications		
Efficiency	Nominal input and full load	See table
Isolation voltage	Input to output	1500VDC (60 second)
Isolation resistance	500VDC	1000MΩ min.
Isolation capacitance		30pF typ.
Switching frequency		150kHz typ.
		300kHz max.
Reliability, calculated MTBF		2×10 ⁶ Hrs
Physical Specifications		
Case material		Plastic (UL94 V-0)
Potting material		PU (UL94 V-0)
Dimensions		19.6× 10.1× 7.0 mm
Weight		2.5g Typ.

Note

1. Io below this value will not damage these converters, however, they may not meet all listed specifications.
2. Typical value, tested at nominal input and full load.
3. For each output.
4. Specifications subject to change without notice.
5. This series of products do not support CC mode, CR mode is recommended.
6. In case of long input lines or hot plug-in requirements, we recommended to use an external low ESR capacitor (22uF) near to the converter's input pins.

Power Derating Curve

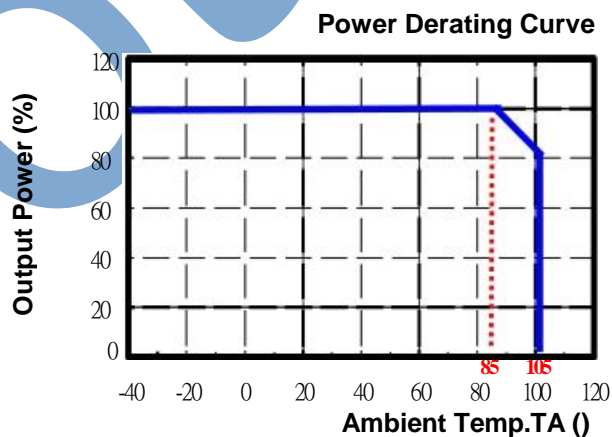

Mechanical Dimensions

Single output

Dual output

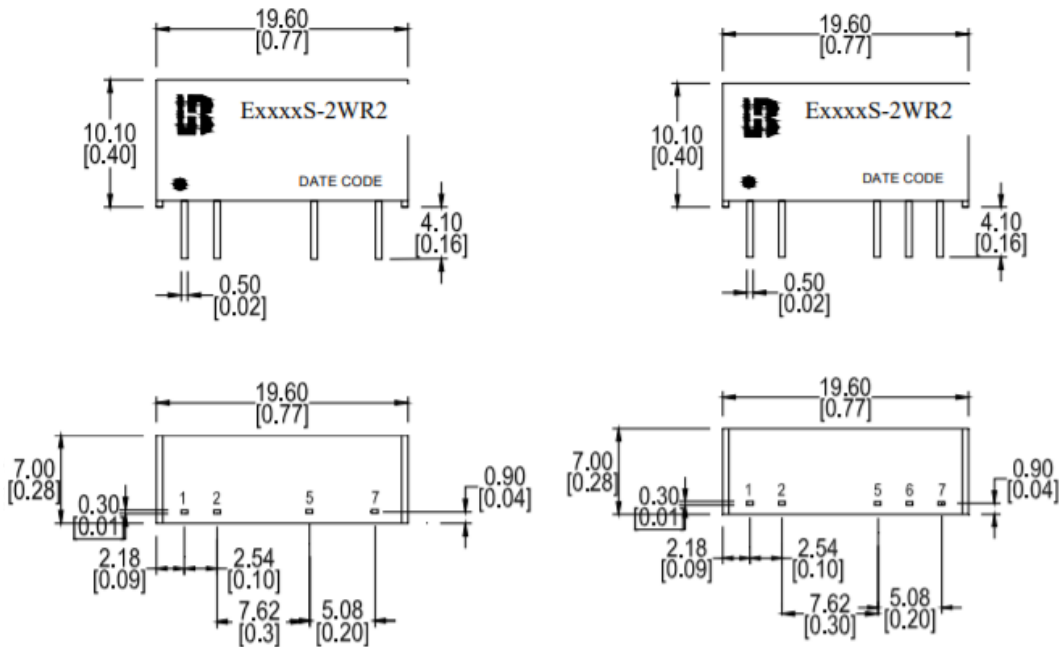

Unit: mm (inch)
Pin section tolerances: $\pm 0.1 (\pm 0.004)$
General tolerances: $\pm 0.5 (\pm 0.02)$

Pin Assignment		
Pin	Single	Dual
1	+Vin	+Vin
2	-Vin	-Vin
5	-Vout	-Vout
6	No pin	Common
7	+Vout	+Vout

Test Configurations

All specifications are typical at nominal input, full load and 25°C unless otherwise stated.

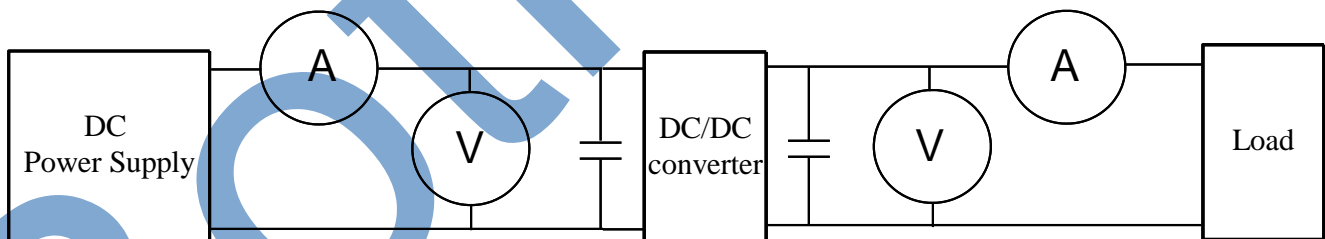

- ©DC Power Supply: It offers a wide voltage and current range precisely.
- ©Current meter (A): Accuracy $\rightarrow 200\mu\text{A} \sim 200\text{mA}$ 4 ranges $\pm (0.2\% \text{ rdg} + 2 \text{ digits})$
 $2000\text{mA} \sim 20\text{A}$ 2 ranges $\pm (0.3\% \text{ rdg} + 2 \text{ digits})$.
- ©Voltage meter (V): Accuracy $\rightarrow \pm (0.03\% \text{ rdg} + 4 \text{ digits})$.
- ©Load: At full load.
- ©Wires: The resistance of the wires must be small.

1. **Input voltage range:** Narrow input voltage range ($\pm 10\%$)、wide input voltage range (2:1 and 4:1)。

EX: Narrow input voltage range ($\pm 10\%$)
5V nominal input \rightarrow 4.5~5.5V
12V nominal input \rightarrow 10.8~13.2V

24V nominal input → 21.6~26.4V

Wide input voltage range 2:1

5V nominal input → 4.5~9V
 12V nominal input → 9~18V
 24V nominal input → 18~36V
 48V nominal input → 36~75V

Wide input voltage range 4:1 (W)

24V nominal input → 9~36V
 48V nominal input → 18~75V

2. Input power :

$$P_{in} = V_{in} \times I_{in}$$

V_{in} : Input voltage
 I_{in} : Input current

3. Output power :

$$P_{out} = V_{out} \times I_{out}$$

V_{out} : Output voltage
 I_{out} : Output current

4. Efficiency :

$$\text{Efficiency} = \frac{P_{out}}{P_{in}} \times 100\%$$

P_{out} : Output power
 P_{in} : Input power

5. Voltage accuracy:

$$\frac{|V_{out} - V_{out(nominal)}|}{V_{out}} \times 100\%$$

V_{out} : Output voltage
 $V_{out(nominal)}$: Nominal output voltage

6. Line regulation:

Narrow input voltage range ($\pm 10\%$) and unregulated output voltage series.

$$\text{Line regulation} = \frac{\Delta V_{out}}{\Delta V_{in}}$$

$$\Delta V_{out} = \frac{V_{out(+10\%)} - V_{out(-10\%)}}{V_{out}} \times 100\%$$

$V_{out(+10\%)}$: Output voltage at $V_{in} = 1.1 \times V_{in(nominal)}$ & full load

$V_{out(-10\%)}$: Output voltage at $V_{in} = 0.9 \times V_{in(nominal)}$ & full load

V_{out} : Output voltage at $V_{in} = V_{in(nominal)}$ & full load

$$\Delta V_{in} = \frac{V_{in(+10\%)} - V_{in(-10\%)}}{V_{in(nominal)}} \times 100\%$$

$V_{in(+10\%)}$: Input voltage = $1.1 \times V_{in(nominal)}$

$V_{in(-10\%)}$: Input voltage = $0.9 \times V_{in(nominal)}$

$V_{in(nominal)}$: Nominal Input voltage

7. Load regulation :

$$\frac{|V_{out(FL)} - V_{out(NL)}|}{V_{out(FL)}} \times 100\%$$

V_{out(FL)}: Output voltage at full load

V_{out(NL)}: Output voltage at 25% full load or 10% full load

8. **Ripple and Noise**: as shown below. The bandwidth is 0-20MHz.

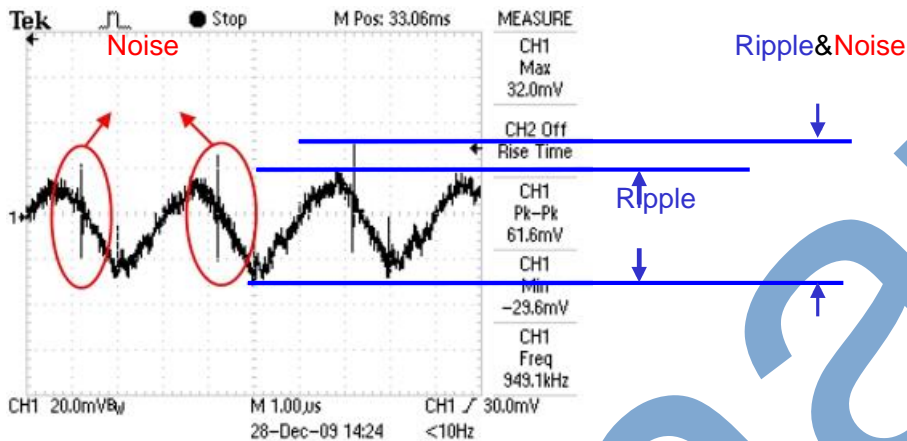

Output Ripple&Noise measurement test circuit: as shown below.

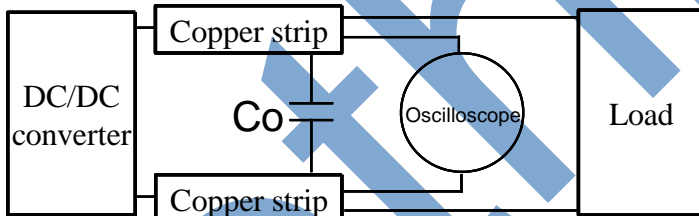

Co: usually 0.47µF.

9. **Temperature derating curve**: The DC-DC converter will operate over a wider temperature range if less power is drawn from the output and the device is already running. The temperature derating curve shows the operating power-temperature range. As shown below.

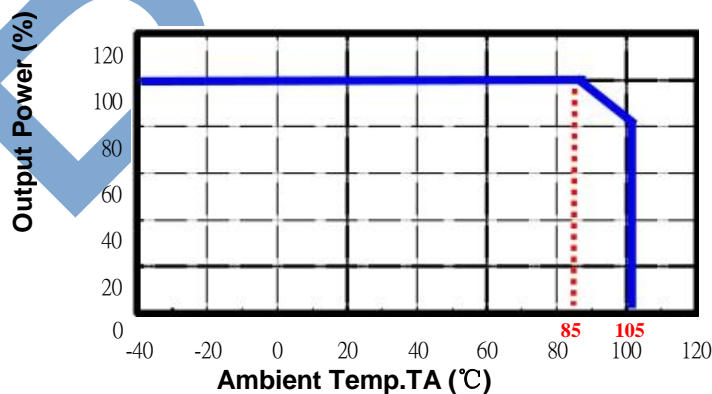

10. **Switching frequency**: The nominal operating frequency of the DC-DC converters.

11. [Input to output isolation](#): The dielectric breakdown strength test between input and output circuits. This is the isolation voltage the device is capable of withstanding for a specified time, usually 1 second or 1 minute.

12. [Input source impedance](#): The power module should be connected to low ac-impedance input source.

Highly inductive source impedances can affect the stability of the power module. In applications where power is supplied over long lines and output loading is high, it may be necessary to use a capacitor at the input to ensure startup. A capacitor mounted close to the power module helps ensure stability of the unit, it is recommended to use a good quality low Equivalent Series Resistance (ESR < 0.1Ω at 100KHz) capacitor of a 22μF for the power module.

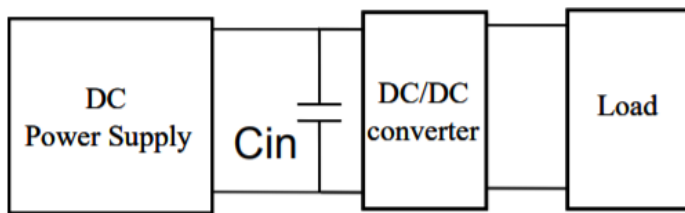

X-ON Electronics

Largest Supplier of Electrical and Electronic Components

Click to view similar products for [Power Management Modules](#) category:

Click to view products by [Bothhand](#) manufacturer:

Other Similar products are found below :

[FPF1C2P5BF07A](#) [FPF1C2P5MF07AM](#) [FH2000NPBAP](#) [B0505S-2W](#) [HLK-5D1205](#) [HLK-10D4805B](#) [B0505XT-1WR2-R](#) [B0505S-1W](#)
[B1224S-1WR2](#) [AP24N20-HV](#) [TAS25-24-W](#) [TAS10-5-W](#) [TAS10-24-W](#) [TAD10-1505-NI](#) [LS03-13B09R3](#) [HCES1-05D12](#) [HCS2-12D15](#)
[DC2626A](#) [DFR0756](#) [CS-POWEEVER-02](#) [CS-POWEEVER-01](#) [01D-6R5-2A](#) [11D-05S05NANL](#) [12D-03S05N3KVAC](#) [12D-](#)
[05S05N3WNL](#) [12D-05S05RNL](#) [12D-24S05R2W](#) [12DA-05S05N2W](#) [13D-05S05NCNL](#) [13DS1-12D09NNL](#) [13DSB-05S05N1.5KV](#) [14D-](#)
[12S03R1KVNL](#) [14DB-05S05N1.5KV](#) [14DZ-05S05R2W](#) [MEE1S0309SC](#) [22D-12D12NCNL](#) [EN5322QI](#) [LTM4624EY#PBF](#) [1SP0340V2M0-](#)
[45](#) [IGD515EI](#) [1SP0335D2S1-5SNA0750G650300](#) [2SP0115T2A0-FF600R12ME4](#) [2SP0115T2A0-12](#) [2SD106AI-17](#) [UL](#) [2SC0635T2A1-45](#)
[2SC0115T2A0-12](#) [2SC0108T2F1-17](#) [1SD210F2-MBN1200H45E2-H_Opt1](#) [A0505S-1W](#) [A0505S-1WR2](#)