

»Features

- Fast Switching Speed
- High Conductance
- Low forward voltage
- Fast reverse recovery time

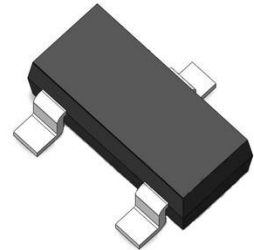

»General Description

- SOT-23 Small Outline Plastic Package
- Polarity: Color band denotes cathode end
- Mounting Position: Any

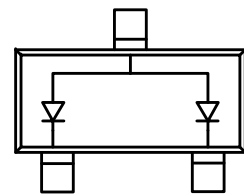

»Absolute Maximum Ratings @ $T_A=25^{\circ}\text{C}$ unless otherwise noted

Symbol	Parameter	Value	Unit
VRM	Non-Repetitive Peak Reverse Voltage	85	V
VR	DC Blocking Voltage	80	V
IFM	Forward Continuous Current	300	mA
IO	Average Rectified Output Current	100	mA
IFSM	Non-repetitive Peak Forward Surge Current@8.3mS	2.0	A
Pd	Power Dissipation	150	mW
RθJA	Thermal Resistance From Junction To Ambient	800	$^{\circ}\text{C}/\text{W}$
TJ	Operation Junction Temperature Range	-55~+150	$^{\circ}\text{C}$
TSTG	Storage Temperature Range	-55~+150	$^{\circ}\text{C}$

»Electrical Characteristics @ $T_A=25^{\circ}\text{C}$ unless otherwise noted

Symbol	Parameter	Test conditions	Min	Typ	Max	Unit
V(BR)	Reverse breakdown voltage	IR=100μA	80			V
IR	Reverse current	VR=80V			0.5	μA
		VR=30V			100	nA
VF1	Forward voltage	IF=1mA		0.61	0.715	V
VF2		IF=10mA		0.74	0.855	V
VF3		IF=100mA		0.92	1.2	V
CT	Capacitance between terminals	VR=0V, f=1MHz		2.2	4	pF
trr	Reverse recovery time	IF=IR=10mA, I _{rr} =0.1XIR		1.6	4	nS

»Typical Performance Characteristics ((T_J = 25 °C, unless otherwise noted))

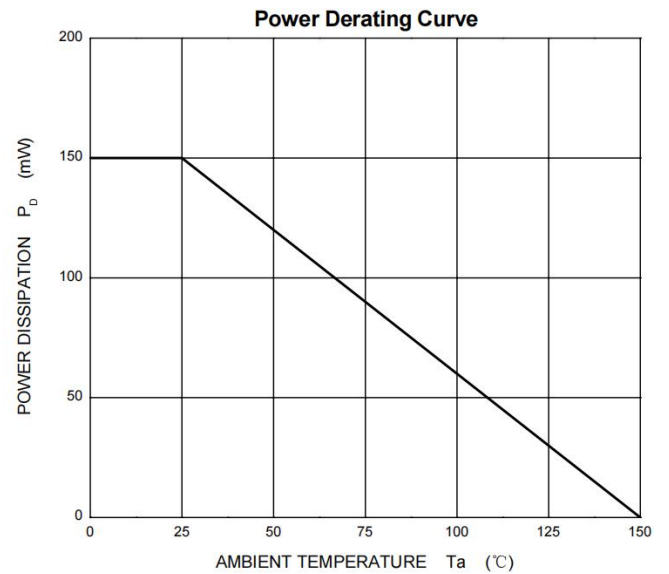
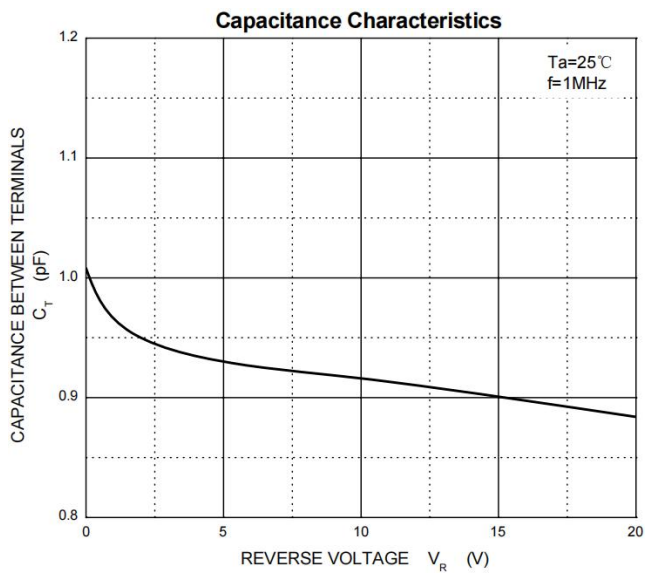
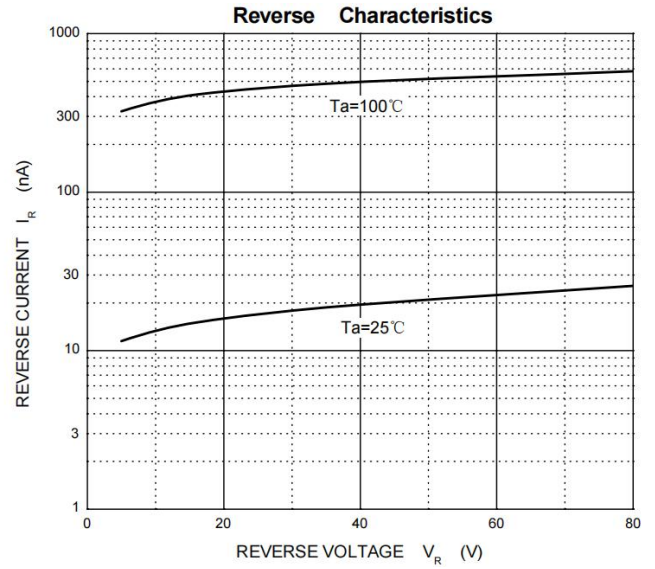
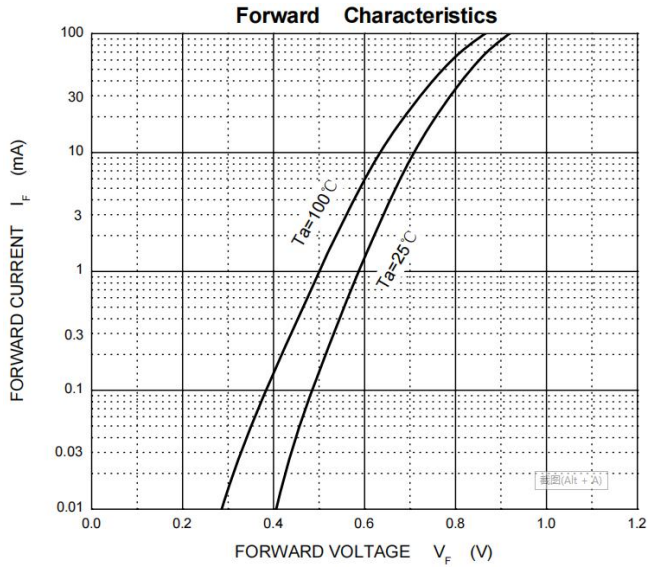

»Package Information SOT-23

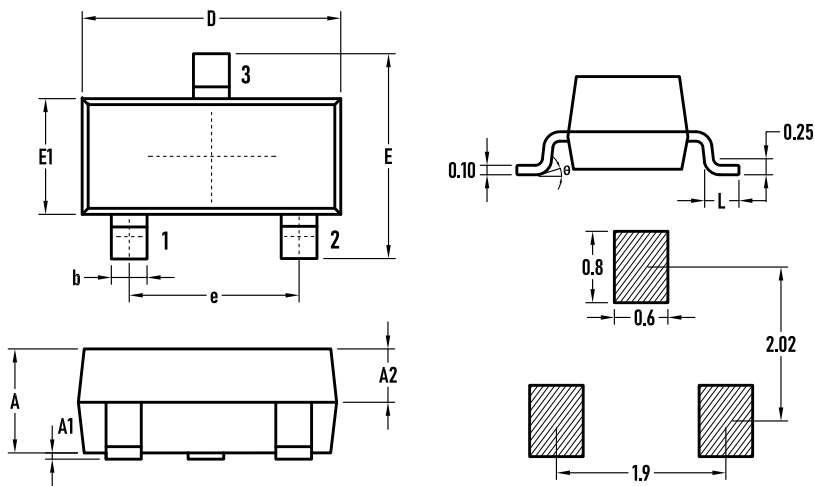

SYMBOL	MILLIMETER		
	MIN.	Typ.	MAX.
A	0.90	1.00	1.10
A1	0.02	0.06	0.10
A2	–	0.60	–
D	2.85	2.90	2.95
b	0.37	0.40	0.43
E	2.35	2.40	2.45
E1	1.25	1.30	1.35
e	1.85	1.90	1.95
L	0.35	0.40	0.48
θ	0	–	6°

»Marking

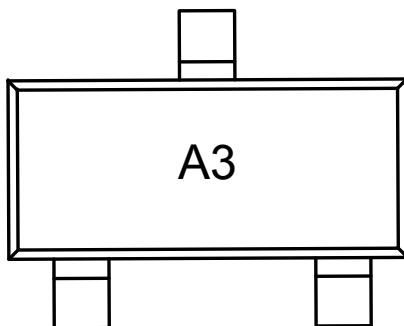

»Ordering information

Order code	Package	Base qty	Delivery mode
1SS181	SOT-23	3K	Tape and reel

X-ON Electronics

Largest Supplier of Electrical and Electronic Components

Click to view similar products for [Diodes - General Purpose, Power, Switching category:](#)

Click to view products by [Bourne manufacturer:](#)

Other Similar products are found below :

[MCL4151-TR3](#) [MMBD3004S-13-F](#) [RD0306T-H](#) [1N3611](#) [NTE156A](#) [NTE574](#) [NTE6244](#) [1SS193,LF](#) [1SS400CST2RA](#) [SDAA13](#)
[SHN2D02FUTW1T1G](#) [LS4151GS08](#) [1N4449](#) [1N456A](#) [1N4934-E3/73](#) [1N914BTR](#) [RFUH20TB3S](#) [D291S45T](#) [BAV300-TR](#) [BAW56DWQ-](#)
[7-F](#) [BAW56M3T5G](#) [BAW75-TAP](#) [MM230L-CAA](#) [IDW40E65D1](#) [JAN1N3600](#) [JAN1N4454UR-1](#) [LL4151-GS18](#) [SMMSD4148T3G](#)
[BYW95B/A52A](#) [NSVDAN222T1G](#) [CDSZC01100-HF](#) [LL4150-M-08](#) [1N4454-TR](#) [BAV70HDW-7](#) [BAS28-7](#) [JANTX1N6640](#) [BAW56HDW-](#)
[13](#) [BAS28 TR](#) [VS-HFA04SD60STR-M3](#) [NSVM1MA152WKT1G](#) [1SS388-TP](#) [RGP30D-E3/73](#) [VS-8EWF02S-M3](#) [BAV99TQ-13-F](#)
[BAV99HDW-13](#) [MMDB30-E28X](#) [IDP20C65D2XKSA1](#) [LS4148](#) [IDV15E65D2](#) [NSVM1MA152WAT1G](#)