

»Features

$V_{CE} = -50V$   
 $I_C = -150mA$   
 $f_T = 80MHz @V_{CE}=-10V, I_C=-1mA, f=30MHz$

»Pin Configurations

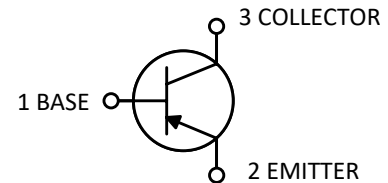

»General Description

- Complementary to C945
- Epitaxial planar die construction
- SOT-23 Plastic Package.

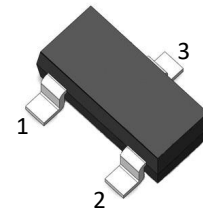

»Absolute Maximum Ratings @ $T_A=25^{\circ}C$  unless otherwise noted

Symbol	Parameter	Value	Unit
$V_{CBO}$	Collector-Base Voltage	-60	V
$V_{CEO}$	Collector-Emitter Voltage	-50	V
$V_{EBO}$	Emitter-Base Voltage	-5	V
$I_C$	Collector Current	-150	mA
$P_C$	Collector Power Dissipation	200	mW
$R_{\theta JA}$	Thermal Resistance From Junction To Ambient	625	$^{\circ}C/W$
$T_J, T_{stg}$	Operation Junction And Storage Temperature Range	-55~+150	$^{\circ}C$

»Electrical Characteristics @ $T_A=25^{\circ}C$  unless otherwise noted

Symbol	Parameter	Test conditions	Min	Typ	Max	Unit
$V_{(BR)CBO}$	Collector-base breakdown voltage	$I_C=-100\mu A, I_E=0$	-60			V
$V_{(BR)CEO}$	Collector-emitter breakdown voltage	$I_C=-1mA, I_B=0$	-50			V
$V_{(BR)EBO}$	Emitter-base breakdown voltage	$I_E=-50\mu A, I_C=0$	-5			V
$I_{CBO}$	Collector cut-off current	$V_{CB}=-60V, I_E=0$			-100	nA
$I_{EBO}$	Emitter cut-off current	$V_{EB}=-5V, I_C=0$			-100	nA
$h_{FE}$	DC current gain	$V_{CE}=-6V, I_C=-1mA$	120		475	
$V_{CE(sat)}$	Collector-emitter saturation voltage	$I_C=-100mA, I_B=-10mA$		-0.18	-0.3	V
$V_{BE(ON)}$	Base-emitter voltage	$V_{CE}=-6V, I_C=-1.0mA$	-0.58	-0.62	-0.68	V
$f_T$	Transition frequency	$V_{CE}=-10V, I_C=-1mA, f=30MHz$	80			MHz
Cob	Output capacitance	$V_{CB}=-10V, I_E=0, f=1MHz$		4.5	7	pF
NF	Noise Figure	$V_{CE}=-6V, I_C=-0.3mA, f=100Hz, R_g=10k\Omega$		6	20	dB

» Typical Performance Characteristics ((T<sub>J</sub> = 25 °C, unless otherwise noted))

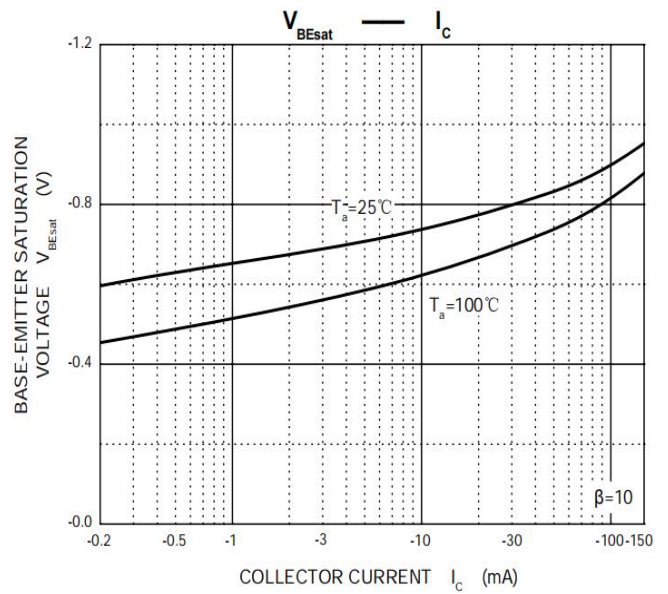
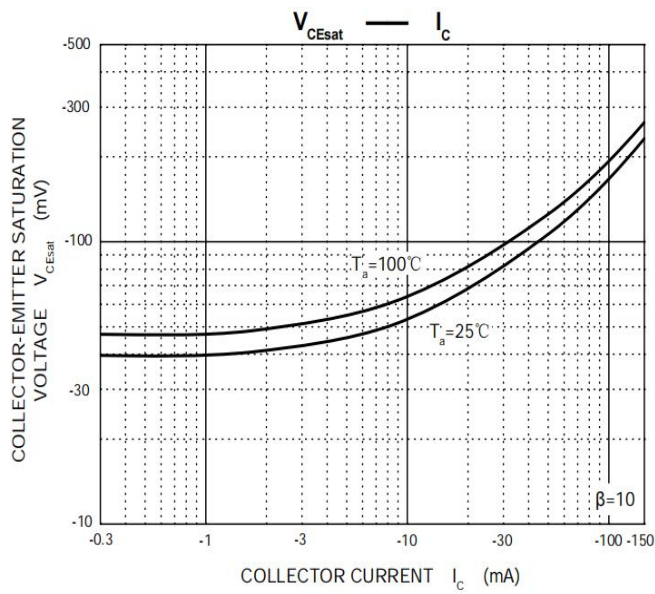
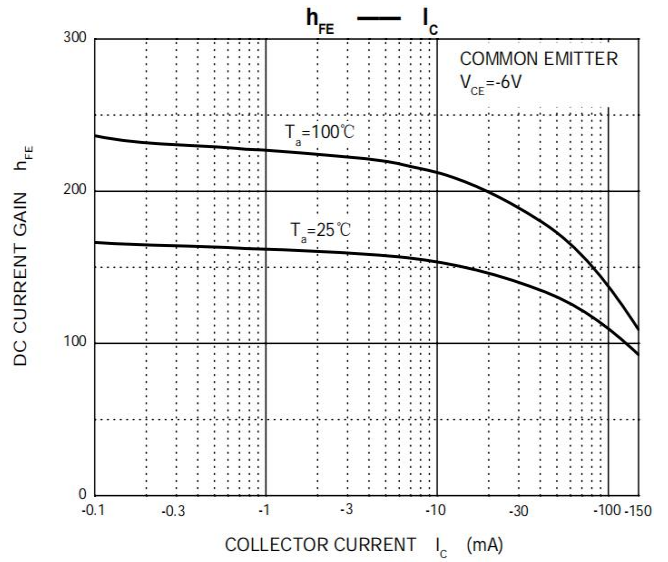
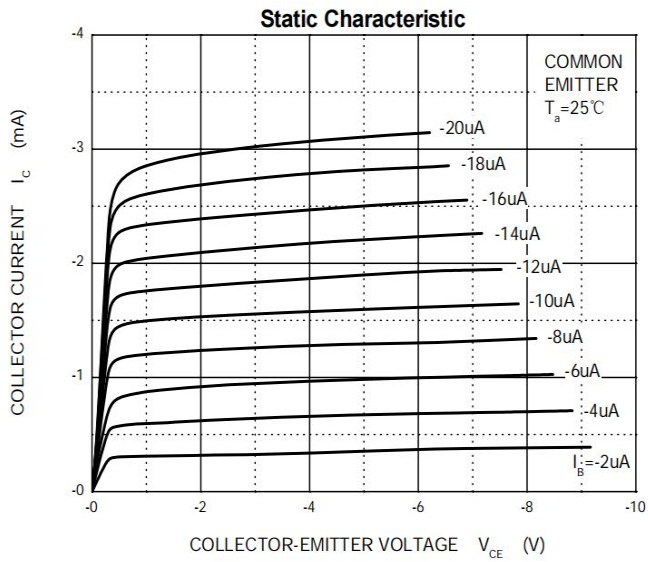

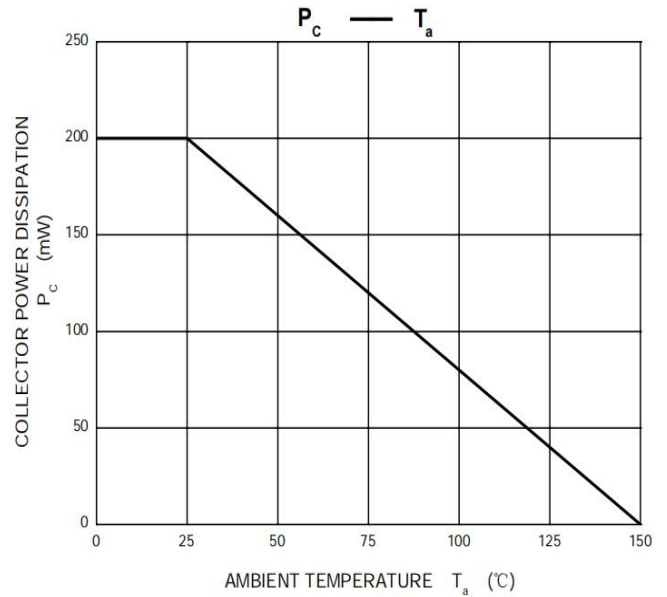
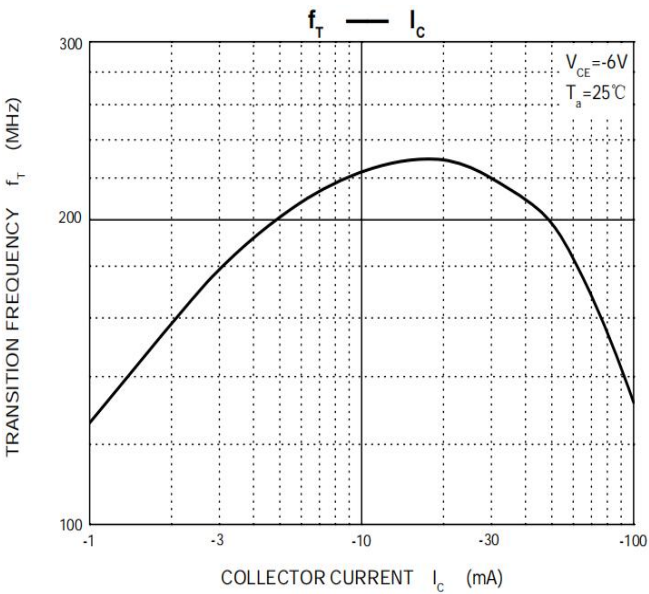
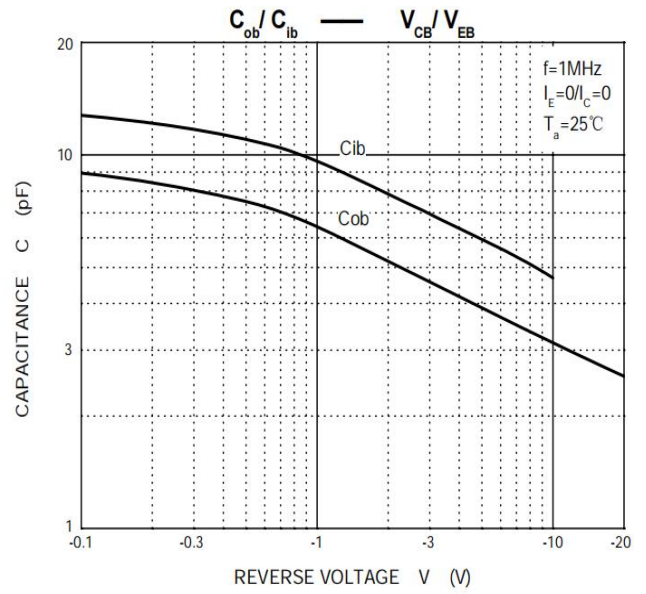
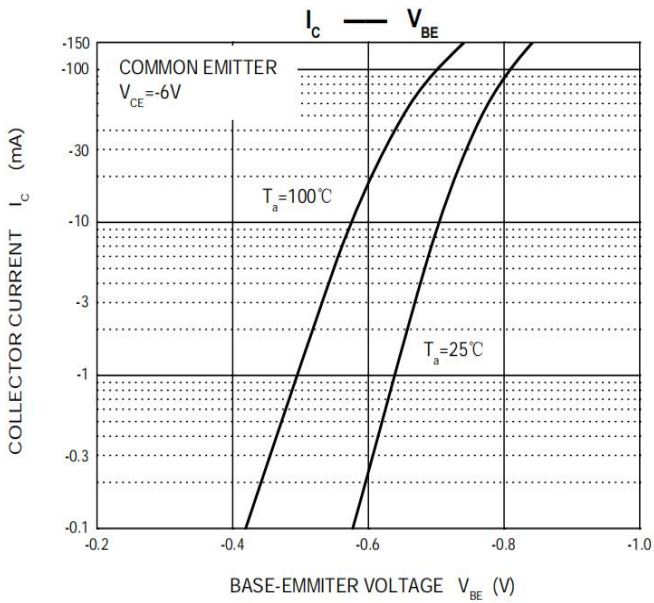

»Package Information SOT-23

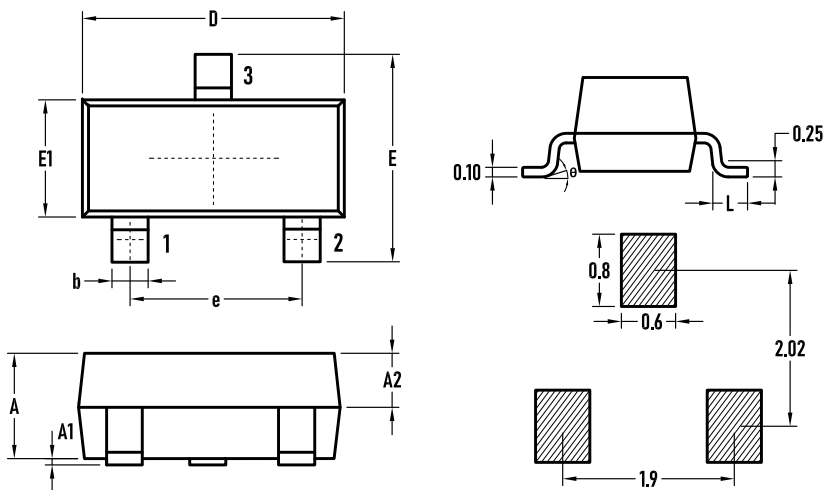

SYMBOL	MILLIMETER		
	MIN.	Typ	MAX
A	0.90	1.00	1.10
A1	0.02	0.06	0.10
A2	–	0.60	–
D	2.85	2.90	2.95
b	0.37	0.40	0.43
E	2.35	2.40	2.45
E1	1.25	1.30	1.35
e	1.85	1.90	1.95
L	0.35	0.40	0.48
θ	0	–	6°

»HFE Classifications & Marking

h <sub>FE</sub>	120~220	220~475
Marking		

»Ordering information

Order code	Package	Base qty	Delivery mode
A733	SOT-23	3K	Tape and reel

## X-ON Electronics

Largest Supplier of Electrical and Electronic Components

*Click to view similar products for [Bipolar Transistors - BJT category](#):*

*Click to view products by [Bourne manufacturer](#):*

Other Similar products are found below :

[BC559C](#) [MCH4017-TL-H](#) [MMBT-2369-TR](#) [BC546/116](#) [NJVMJD148T4G](#) [NTE16](#) [NTE195A](#) [IMX9T110](#) [2N4401-A](#) [2N4403](#) [2N6728](#)  
[2SA1419T-TD-H](#) [2SA2126-E](#) [2SB1204S-TL-E](#) [FMC5AT148](#) [2N2369ADCSM](#) [2N2907A](#) [2N3904-NS](#) [2N5769](#) [2SC4618TLN](#) [CPH6501-](#)  
[TL-E](#) [MCH4021-TL-E](#) [Jantx2N5416](#) [US6T6TR](#) [BAX18/A52R](#) [BC556/112](#) [IMZ2AT108](#) [MMST8098T146](#) [UMX21NTR](#) [MCH6102-TL-E](#)  
[TTA1452B,S4X\(S](#) [2N3879](#) [NTE13](#) [NTE282](#) [NTE323](#) [NTE350](#) [NTE81](#) [JANTX2N2920L](#) [JANTX2N3735](#) [JANSR2N2222AUB](#)  
[CMLT3946EG TR](#) [SNSS40600CF8T1G](#) [CMLT3906EG TR](#) [GRP-DATA-JANS2N2907AUB](#) [GRP-DATA-JANS2N2222AUA](#)  
[MMDT3946FL3-7](#) [2N4240](#) [JANS2N3019](#) [MSB30KH-13](#) [2N2221AUB](#)