

»Features

- Low forward voltage drop
- High current capability
- High reliability
- High surge current capability
- Epitaxial construction



»General Description

- Case: molded plastic
- Polarity: Color band denotes cathode
- Package: SOT-23 Plastic Package

»Circuit and Marking

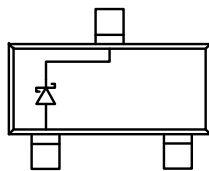

BAS40: 43

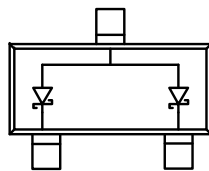

BAS40-06:46

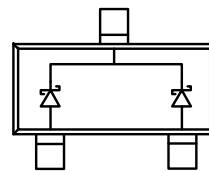

BAS40-05: 45

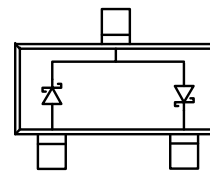

BAS40-04:44

» Maximum Ratings @ $T_A=25^{\circ}\text{C}$ unless otherwise noted

Symbol	Parameter	Value	Unit
VRRM VRWM VR	Peak Repetitive Peak Reverse Voltage Working Peak Reverse Voltage DC Blocking Voltage	40	V
IFM	Forward Continuous Current	200	mA
IO	Average Rectified Output Current	200	mA
IFSM	Non-repetitive Peak Forward Surge Current@8.3mS	0.6	A
Pd	Power Dissipation	200	mW
RθJA	Thermal Resistance From Junction To Ambient	450	°C/W
TJ	Operation Junction Temperature Range	-40~+125	°C
TSTG	Storage Temperature Range	-55~+150	°C

» **Electrical Characteristics** @ $T_A=25^\circ\text{C}$ unless otherwise noted

Symbol	Parameter	Test conditions	Min	Max	Unit
V(BR)	Reverse breakdown voltage	$I_R=10\mu\text{A}$	40		V
I_R	Reverse current	$V_R=30\text{V}$		200	nA
VF	Forward voltage	$I_F=1\text{mA}$		380	mV
		$I_F=40\text{mA}$		1000	mV
CD	Diode capacitance	$V_R=0\text{V}, f=1\text{MHz}$		5	pF
t_{rr}	Reverse recovery time	$I_F=I_R=10\text{mA}, I_{rr}=1\text{mA}, R_L=100\Omega$		5	nS

» **Typical Performance Characteristics** ($T_J = 25^\circ\text{C}$, unless otherwise noted)

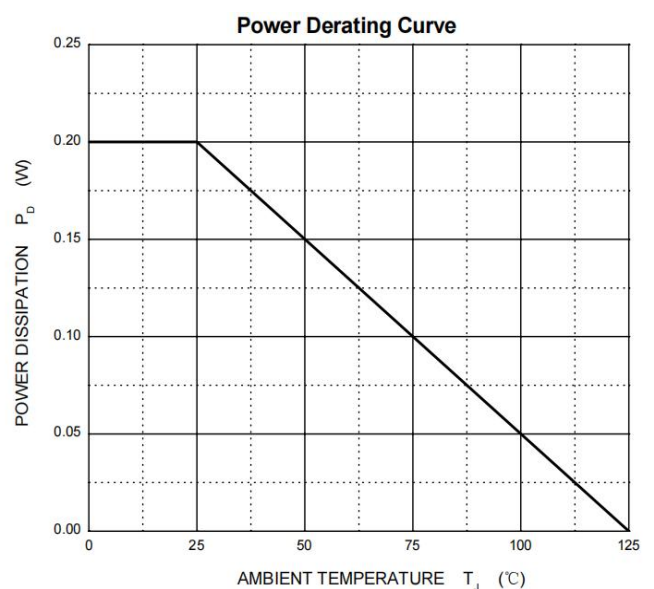
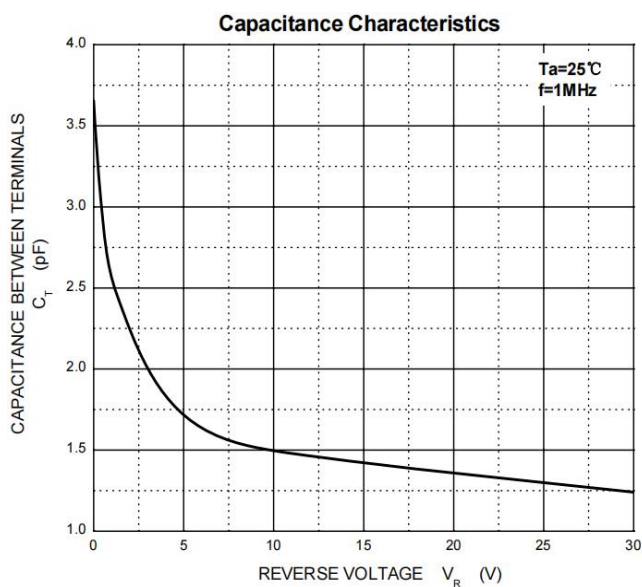
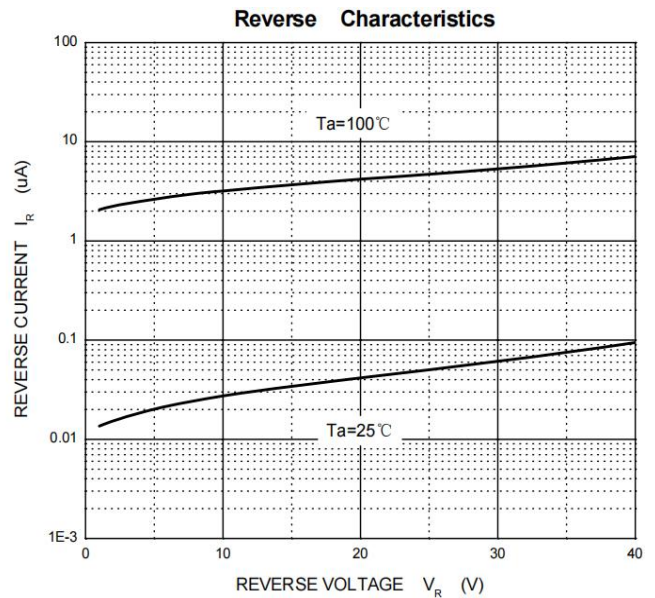
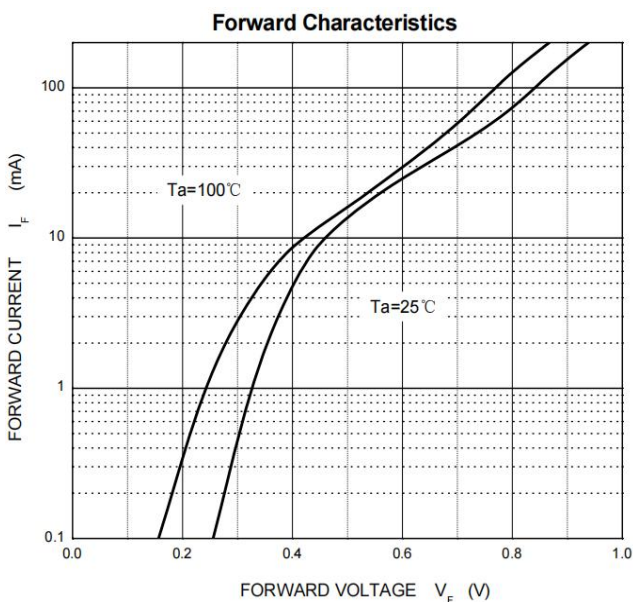

»Package Information SOT-23

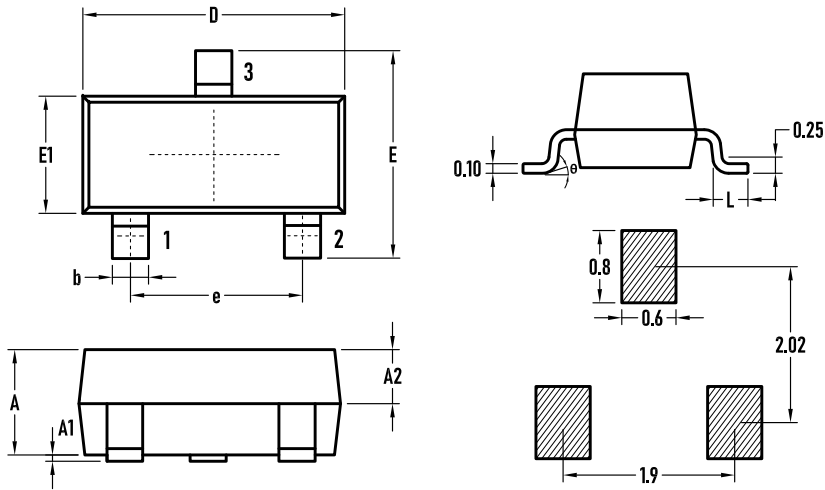

SYMBOL	MILLIMETER		
	MIN.	Typ	MAX
A	0.90	1.00	1.10
A1	0.02	0.06	0.10
A2	–	0.60	–
D	2.85	2.90	2.95
b	0.37	0.40	0.43
E	2.35	2.40	2.45
E1	1.25	1.30	1.35
e	1.85	1.90	1.95
L	0.35	0.40	0.48
θ	0	–	6°

»Ordering information

Order code	Package	Base qty	Delivery mode
BAS40/-04/-05/-06	SOT-23	3K	Tape and reel

X-ON Electronics

Largest Supplier of Electrical and Electronic Components

Click to view similar products for [Schottky Diodes & Rectifiers](#) category:

Click to view products by [Bourne](#) manufacturer:

Other Similar products are found below :

[MA4E2039](#) [MA4E2508M-1112](#) [MBR1545CT](#) [MMBD301M3T5G](#) [RB160M-50TR](#) [D83C](#) [BAS16E6433HTMA1](#) [BAT 54-02LRH E6327](#)
[NRVBAF360T3G](#) [NSR05F40QNXT5G](#) [NTE555](#) [JANS1N6640](#) [SK310-T](#) [SS3003CH-TL-E](#) [GA01SHT18](#) [CRS10I30A\(TE85L,QM](#)
[MA4E2501L-1290](#) [MBRA140TRPBF](#) [MBRB30H30CT-1G](#) [BAT 15-04R E6152](#) [JANTX1N5712-1](#) [DMJ3940-000](#) [SB007-03C-TB-E](#)
[SK33B-TP](#) [NRVBB20100CTT4G](#) [NRVBM120LT1G](#) [NTSB30U100CT-1G](#) [VS-6CWQ10FNHM3](#) [CRG04\(T5L,TEMQ\)](#) [ACDBA1100LR-HF](#)
[ACDBA1200-HF](#) [ACDBA240-HF](#) [ACDBA3100-HF](#) [CDBQC0530L-HF](#) [CDBQC0240LR-HF](#) [ACDBA260LR-HF](#) [ACDBA1100-HF](#)
[MA4E2502L-1246](#) [10BQ015-M3/5BT](#) [NRVBM120ET1G](#) [CRS08TE85LQM](#) [PMAD1108-LF](#) [B120Q-13-F](#) [1N5819T-G](#) [B0530WSQ-7-F](#)
[PDS1040Q-13](#) [B160BQ-13-F](#) [SDM05U20CSP-7](#) [B140S1F-7](#) [HSM560Je3/TR13](#)