

»Features

$V_{CE} = 45V$

$I_C = 0.5A$

$f_T = 100MHz @V_{CE}=5V, I_C=10mA, f=100MHz$

»Pin Configurations

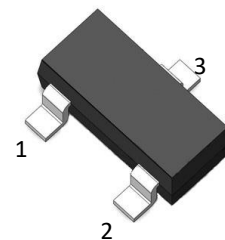
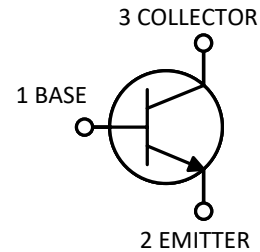

»General Description

- Epitaxial planar die construction
- SOT-23 Plastic Package.

»Absolute Maximum Ratings @ $T_A=25^{\circ}C$ unless otherwise noted

Symbol	Parameter	Value	Unit
V_{CB0}	Collector-Base Voltage	50	V
V_{CEO}	Collector-Emitter Voltage	45	V
V_{EBO}	Emitter-Base Voltage	5	V
I_C	Collector Current	0.5	A
P_C	Collector Power Dissipation	300	mW
$R_{\theta JA}$	Thermal Resistance From Junction To Ambient	400	$^{\circ}C/W$
T_J, T_{stg}	Operation Junction And Storage Temperature Range	-55~+150	$^{\circ}C$

»Electrical Characteristics @ $T_A=25^{\circ}C$ unless otherwise noted

Symbol	Parameter	Test conditions	Min	Typ	Max	Unit
$V_{(BR)CB0}$	Collector-base breakdown voltage	$I_C=10\mu A, I_E=0$	50			V
$V_{(BR)CEO}$	Collector-emitter breakdown voltage	$I_C=10mA, I_B=0$	45			V
$V_{(BR)EBO}$	Emitter-base breakdown voltage	$I_E=1\mu A, I_C=0$	5			V
I_{CBO}	Collector cut-off current	$V_{CB}=45V, I_E=0$			100	nA
I_{EBO}	Emitter cut-off current	$V_{EB}=4V, I_C=0$			100	nA
$h_{FE(1)}$	DC current gain(1)	$V_{CE}=1V, I_C=100mA$	100		600	
$h_{FE(2)}$	DC current gain(2)	$V_{CE}=1V, I_C=500mA$	40			
$V_{CE(sat)}$	Collector-emitter saturation voltage	$I_C=500mA, I_B=50mA$			0.7	V
$V_{BE(sat)}$	Base-emitter saturation voltage				1.2	V
C_{ob}	Collector capacitance	$V_{CB}=10V, f=1MHz$		10		pF
f_T	Transition frequency	$V_{CE}=5V, I_C=10mA, f=100MHz$	100			MHz

»Typical Performance Characteristics (($T_J = 25\text{ }^\circ\text{C}$, unless otherwise noted))

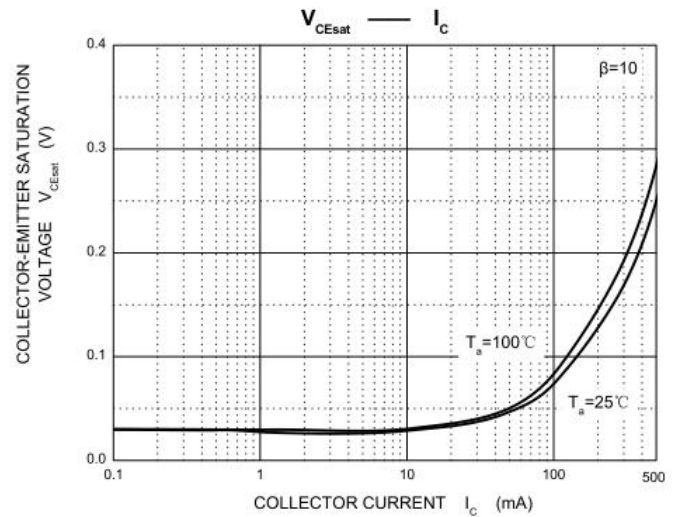
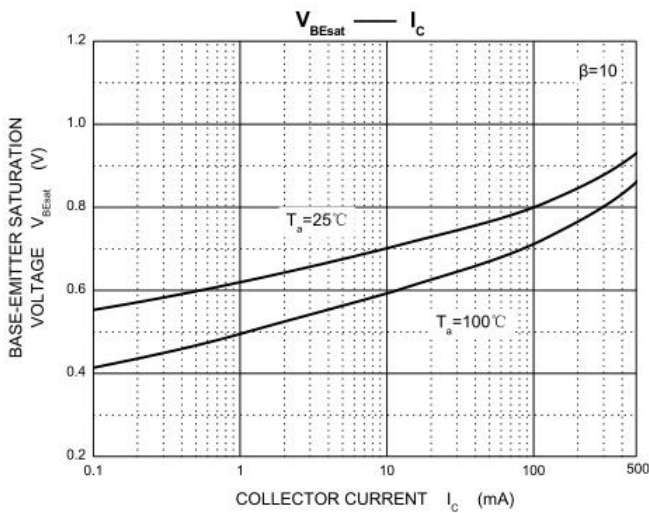
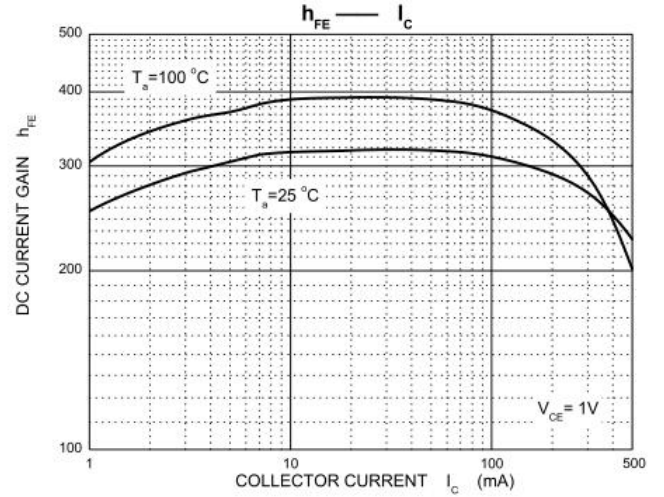
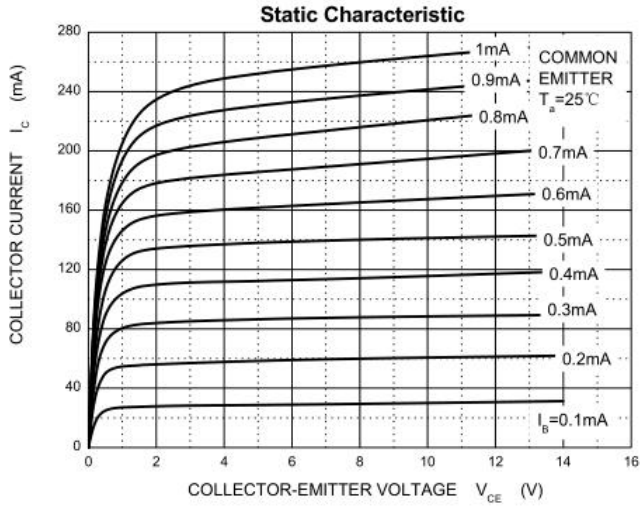

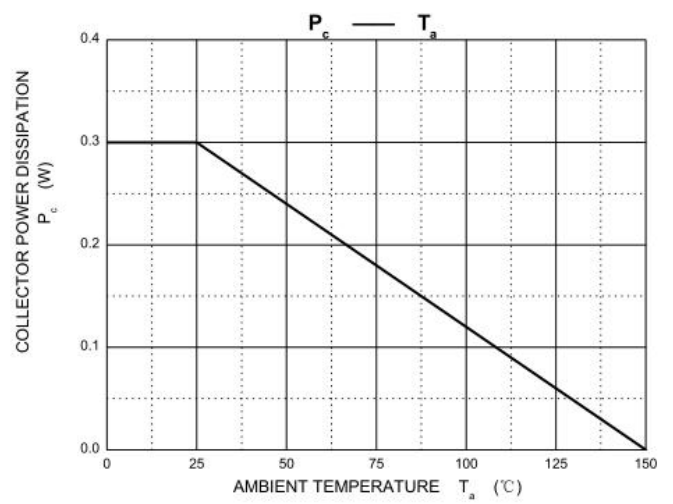
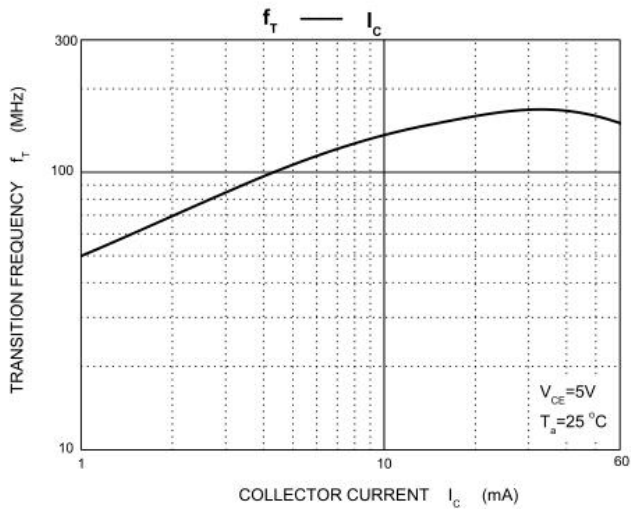
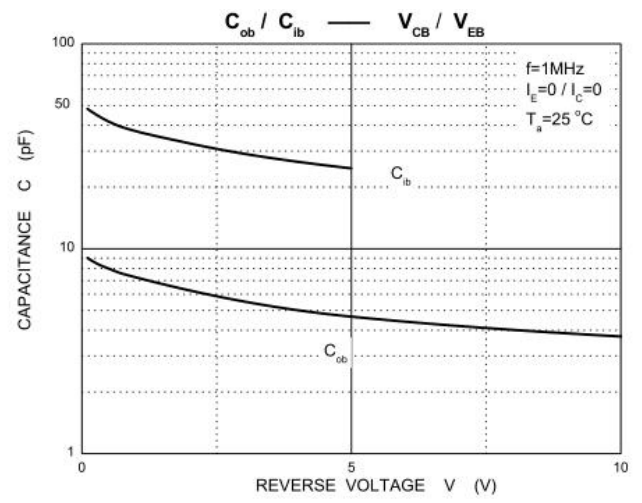
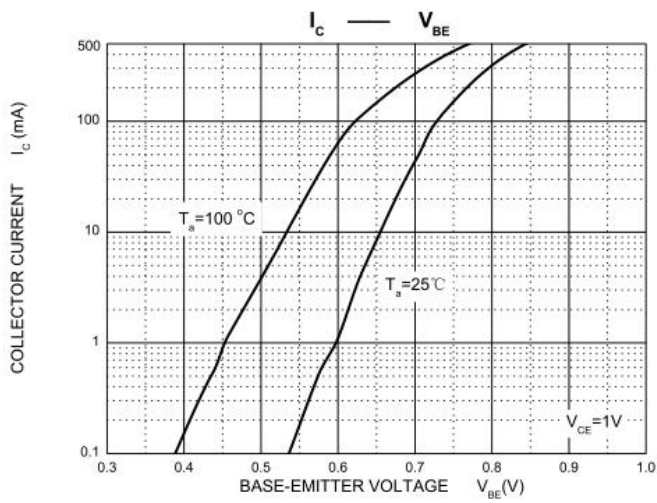

»Package Information-SOT23

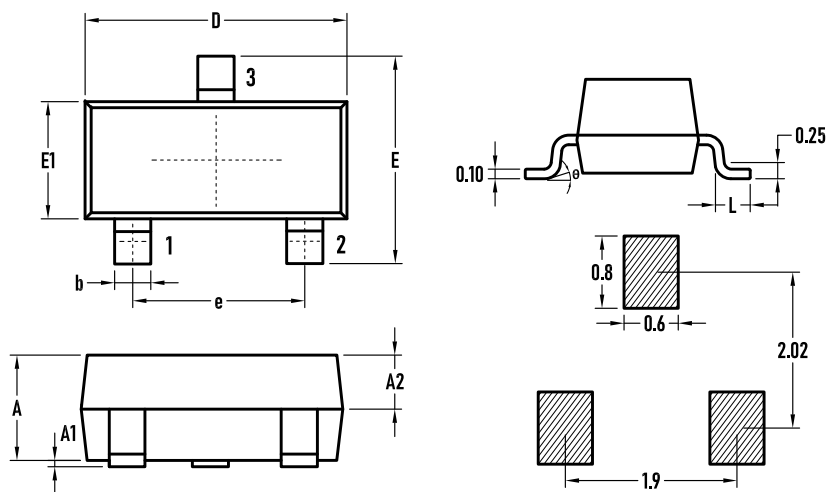

SYMBOL	MILLIMETER		
	MIN.	Typ	MAX
A	0.90	1.00	1.10
A1	0.02	0.06	0.10
A2	–	0.60	–
D	2.85	2.90	2.95
b	0.37	0.40	0.43
E	2.35	2.40	2.45
E1	1.25	1.30	1.35
e	1.85	1.90	1.95
L	0.35	0.40	0.48
θ	0	–	6°

»Marking

Part No.	BC817-16	BC817-25	BC817-40
h_{FE}	100~250	160~400	250~600
Marking			

»Ordering information

Order code	Package	Base qty	Deliverymode
BC817	SOT-23	3K	Tape and reel

X-ON Electronics

Largest Supplier of Electrical and Electronic Components

Click to view similar products for [Bipolar Transistors - BJT category](#):

Click to view products by [Bourne manufacturer](#):

Other Similar products are found below :

[BC559C](#) [MCH4017-TL-H](#) [MMBT-2369-TR](#) [BC546/116](#) [NJVMJD148T4G](#) [NTE16](#) [NTE195A](#) [IMX9T110](#) [2N4401-A](#) [2N4403](#) [2N6728](#)
[2SA1419T-TD-H](#) [2SA2126-E](#) [2SB1204S-TL-E](#) [FMC5AT148](#) [2N2369ADCSM](#) [2N2907A](#) [2N3904-NS](#) [2N5769](#) [2SC4618TLN](#) [CPH6501-](#)
[TL-E](#) [MCH4021-TL-E](#) [Jantx2N5416](#) [US6T6TR](#) [BAX18/A52R](#) [BC556/112](#) [IMZ2AT108](#) [MMST8098T146](#) [UMX21NTR](#) [MCH6102-TL-E](#)
[TTA1452B,S4X\(S](#) [2N3879](#) [NTE13](#) [NTE282](#) [NTE323](#) [NTE350](#) [NTE81](#) [JANTX2N2920L](#) [JANTX2N3735](#) [JANSR2N2222AUB](#)
[CMLT3946EG TR](#) [SNSS40600CF8T1G](#) [CMLT3906EG TR](#) [GRP-DATA-JANS2N2907AUB](#) [GRP-DATA-JANS2N2222AUA](#)
[MMDT3946FL3-7](#) [2N4240](#) [MSB30KH-13](#) [2N2221AUB](#) [2SD1815T-TL-E](#)