

»Features

$V_{CE} @ BC846 = 65V$
 $V_{CE} @ BC847 = 45V$
 $V_{CE} @ BC848 = 30V$
 $I_C = 0.1A$
 $f_T = 100MHz @ V_{CE}=5V, I_C=10mA, f=30MHz$

»General Description

- Epitaxial planar die constructio
- SOT-23 Plastic Package.

»Pin Configurations

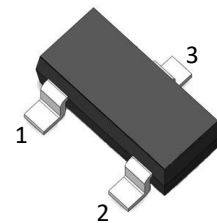
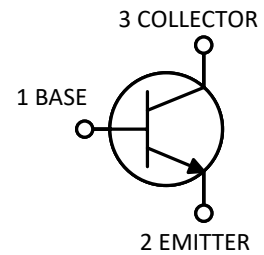

»Absolute Maximum Ratings @ $T_A=25^{\circ}C$ unless otherwise noted

Symbol	Parameter	Part	Value	Unit
V_{CBO}	Collector-Base Voltage	BC846 BC847 BC848	80 50 30	V
V_{CEO}	Collector-Emitter Voltage	BC846 BC847 BC848	65 45 30	V
V_{EBO}	Emitter-Base Voltage		6	V
I_C	Collector Current		100	mA
P_C	Collector Power Dissipation		200	mW
$R_{\theta JA}$	Thermal Resistance From Junction To Ambient		625	$^{\circ}C/W$
T_J, T_{stg}	Operation Junction And Storage Temperature Range		-55~+150	$^{\circ}C$

»Electrical Characteristics @ $T_A=25^{\circ}\text{C}$ unless otherwise noted

Symbol	Parameter	Partnumber	Test conditions	Min	Max	Unit
$V_{(BR)CBO}$	Collector-base breakdown voltage	BC846 BC847 BC848	$I_C=10\mu\text{A}, I_E=0$	80 50 30		V
$V_{(BR)CEO}$	Collector-emitter breakdown voltage	BC846 BC847 BC848	$I_C=10\text{mA}, I_B=0$	65 45 30		V
$V_{(BR)EBO}$	Emitter-base breakdown voltage		$I_E=10\mu\text{A}, I_C=0$	6		V
I_{CBO}	Collector cut-off current	BC846 BC847 BC848	$V_{CB}=70\text{V}, I_E=0$ $V_{CB}=50\text{V}, I_E=0$ $V_{CB}=30\text{V}, I_E=0$		100	nA
I_{EBO}	Emitter cut-off current		$V_{EB}=5\text{V}, I_C=0$		100	nA
h_{FE}	DC current gain	BC846A BC847A BC848A BC846B BC847B BC848B BC846C BC847C BC848C	$V_{CE}=5\text{V}, I_C=2\text{mA}$	110 200 420	220 450 800	
$V_{CE(sat)}$	Collector-emitter saturation voltage		$I_C=100\text{mA}, I_B=5\text{mA}$		0.5	V
$V_{BE(sat)}$	Base-emitter saturation voltage				1.1	V
f_T	Transition frequency		$V_{CE}=5\text{V}, I_C=10\text{mA},$ $f=30\text{MHz}$	100		MHz
Cob	Collector output capacitance		$V_{CB}=10\text{V}, f=1\text{MHz}$		4.5	pF

»Typical Performance Characteristics ((T_J = 25 °C, unless otherwise noted))

Static Characteristic

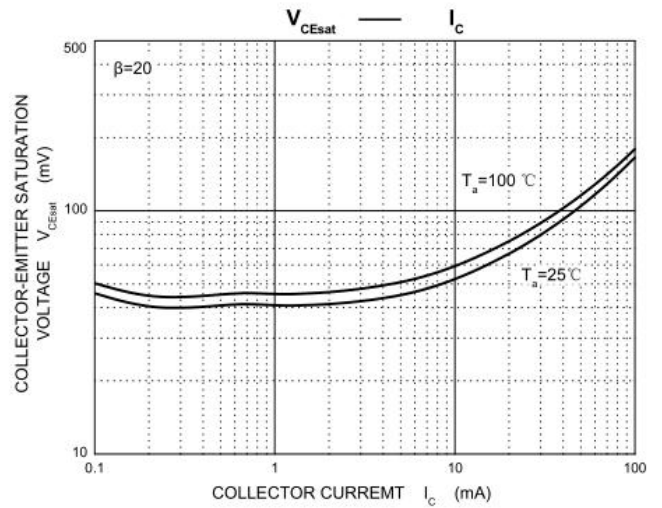
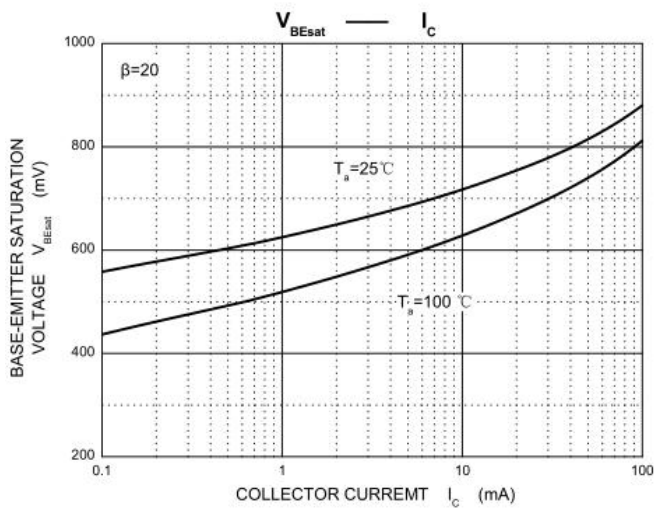
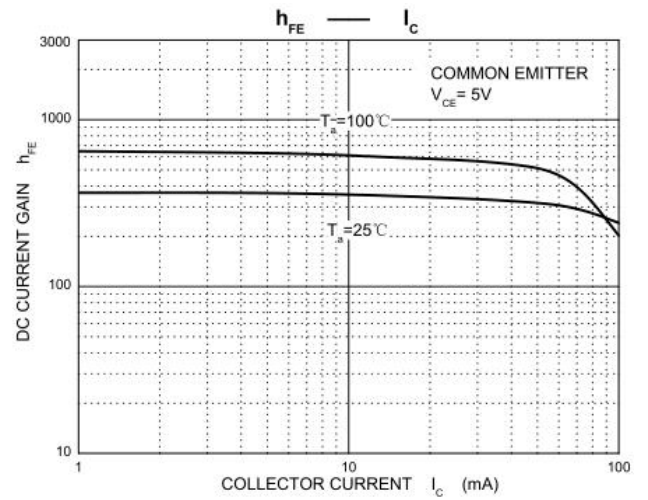
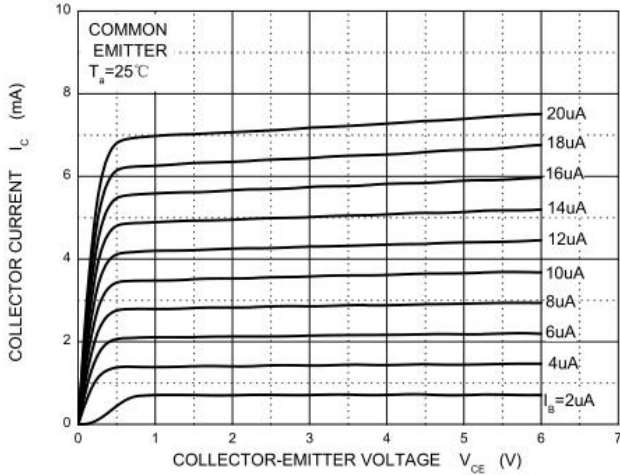

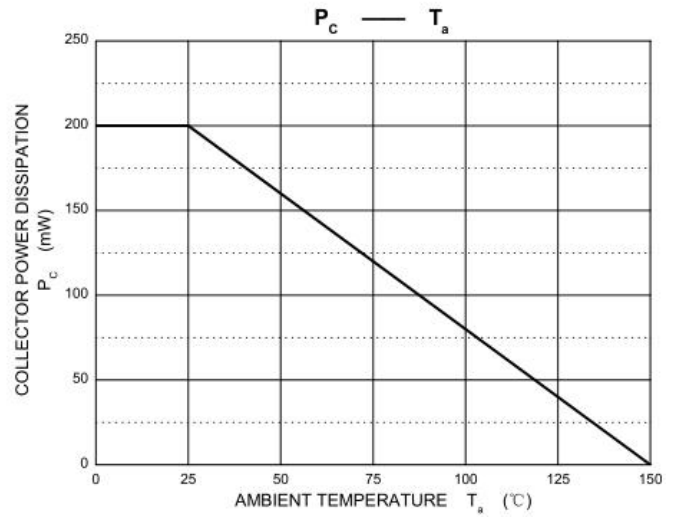
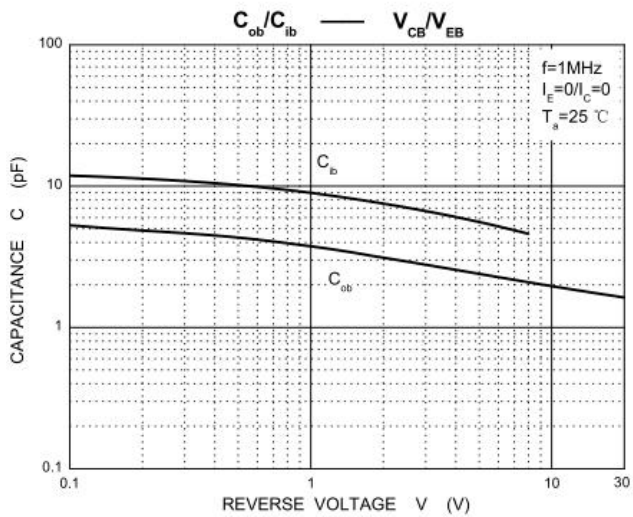
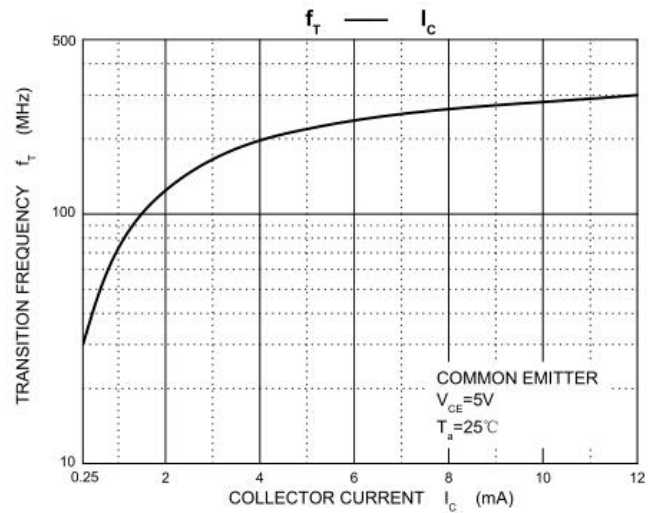
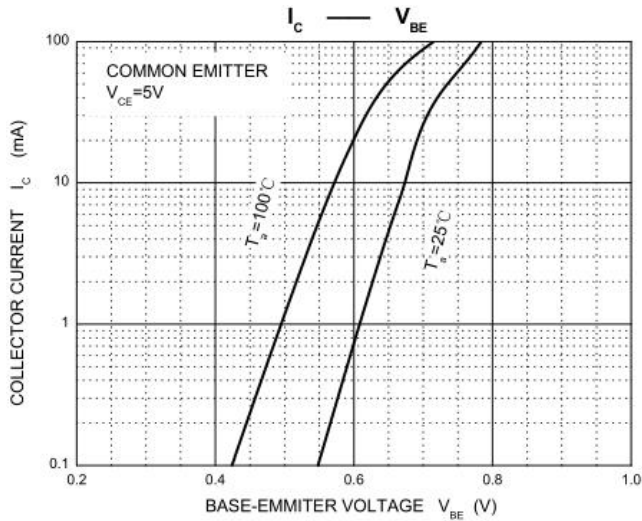

»Package Information-SOT23

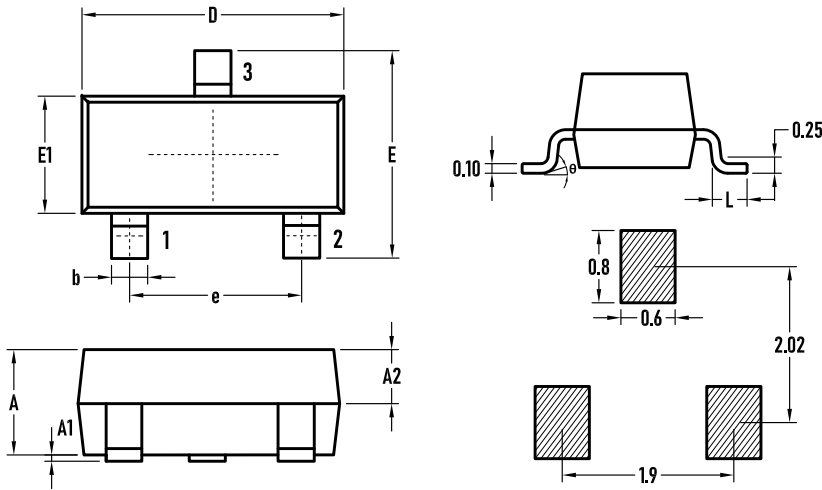

SYMBOL	MILLIMETER		
	MIN.	Typ	MAX
A	0.90	1.00	1.10
A1	0.02	0.06	0.10
A2	–	0.60	–
D	2.85	2.90	2.95
b	0.37	0.40	0.43
E	2.35	2.40	2.45
E1	1.25	1.30	1.35
e	1.85	1.90	1.95
L	0.35	0.40	0.48
θ	0	–	6°

»Marking

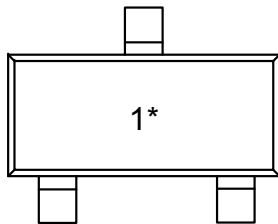

BC846A=1A BC846B=1B BC846C=1C
 BC847A=1E BC847B=1F BC847C=1G
 BC848A=1J BC848B=1K BC848C=1L

»Ordering information

Order code	Package	Base qty	Delivery mode
BC846 BC847 BC848	SOT-23	3K	Tape and reel

X-ON Electronics

Largest Supplier of Electrical and Electronic Components

Click to view similar products for [Bipolar Transistors - BJT category](#):

Click to view products by [Bourne manufacturer](#):

Other Similar products are found below :

[BC559C](#) [MCH4017-TL-H](#) [MMBT-2369-TR](#) [BC546/116](#) [NJVMJD148T4G](#) [NTE16](#) [NTE195A](#) [IMX9T110](#) [2N4401-A](#) [2N4403](#) [2N6728](#)
[2SA1419T-TD-H](#) [2SA2126-E](#) [2SB1204S-TL-E](#) [FMC5AT148](#) [2N2369ADCSM](#) [2N2907A](#) [2N3904-NS](#) [2N5769](#) [2SC4618TLN](#) [CPH6501-](#)
[TL-E](#) [MCH4021-TL-E](#) [Jantx2N5416](#) [US6T6TR](#) [BAX18/A52R](#) [BC556/112](#) [IMZ2AT108](#) [MMST8098T146](#) [UMX21NTR](#) [MCH6102-TL-E](#)
[TTA1452B,S4X\(S](#) [2N3879](#) [NTE13](#) [NTE282](#) [NTE323](#) [NTE350](#) [NTE81](#) [JANTX2N2920L](#) [JANTX2N3735](#) [JANSR2N2222AUB](#)
[CMLT3946EG TR](#) [SNSS40600CF8T1G](#) [CMLT3906EG TR](#) [GRP-DATA-JANS2N2907AUB](#) [GRP-DATA-JANS2N2222AUA](#)
[MMDT3946FL3-7](#) [2N4240](#) [MSB30KH-13](#) [2N2221AUB](#) [2SD1815T-TL-E](#)