

## »Features

$V_{CE} @ BC856 = -65V$

$V_{CE} @ BC857 = -45V$

$V_{CE} @ BC858 = -30V$

$I_C = -0.1A$

$f_T = 100MHz @ V_{CE} = -5V, I_C = -10mA, f = 30MHz$

## »General Description

- Epitaxial planar die constructio
- SOT-23 Plastic Package.

## »Pin Configurations

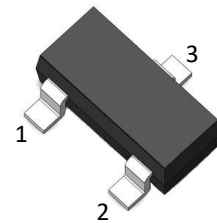
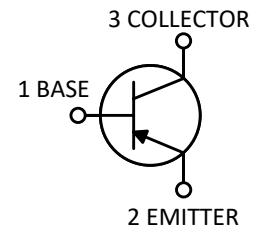

## »Absolute Maximum Ratings @ $T_A = 25^{\circ}C$ unless otherwise noted

Symbol	Parameter	Part	Value	Unit
$V_{CBO}$	Collector-Base Voltage	BC856 BC857 BC858	-80 -50 -30	V
$V_{CEO}$	Collector-Emitter Voltage	BC856 BC857 BC858	-65 -45 -30	V
$V_{EBO}$	Emitter-Base Voltage		-5	V
$I_C$	Collector Current		-100	mA
$P_C$	Collector Power Dissipation		200	mW
$R_{\theta JA}$	Thermal Resistance From Junction To Ambient		625	$^{\circ}C/W$
$T_J, T_{stg}$	Operation Junction And Storage Temperature Range		-55~+150	$^{\circ}C$

**»Electrical Characteristics** @ $T_A=25^{\circ}\text{C}$  unless otherwise noted

Symbol	Parameter	Partnumber	Test conditions	Min	Max	Unit
$V_{(BR)CBO}$	Collector-base breakdown voltage	BC856 BC857 BC858	$I_C=-10\mu\text{A}$ , $I_E=0$	-80 -50 -30		V
$V_{(BR)CEO}$	Collector-emitter breakdown voltage	BC856 BC857 BC858	$I_C=-10\text{mA}$ , $I_B=0$	-65 -45 -30		V
$V_{(BR)EBO}$	Emitter-base breakdown voltage		$I_E=-10\mu\text{A}$ , $I_C=0$	-5		V
$I_{CBO}$	Collector cut-off current	BC856 BC857 BC858	$V_{CB}=-70\text{V}$ , $I_E=0$ $V_{CB}=-50\text{V}$ , $I_E=0$ $V_{CB}=-30\text{V}$ , $I_E=0$		-100	nA
$I_{EBO}$	Emitter cut-off current		$V_{EB}=-5\text{V}$ , $I_C=0$		-100	nA
$h_{FE}$	DC current gain	BC856A BC857A BC858A BC856B BC857B BC858B BC856C BC857C BC858C	$V_{CE}=-5\text{V}$ , $I_C=-2\text{mA}$	110 200 420	220 450 800	
$V_{CE(sat)}$	Collector-emitter saturation voltage		$I_C=-100\text{mA}$ $I_B=-5\text{mA}$		-0.5	V
$V_{BE(sat)}$	Base-emitter saturation voltage				-1.1	V
$f_T$	Transition frequency		$V_{CE}=-5\text{V}$ , $I_C=-10\text{mA}$ ,	100		MHz
$C_{ob}$	Collector output capacitance		$f=30\text{MHz}$ $V_{CB}=-10\text{V}$ , $f=1\text{MHz}$		4.5	pF

»Typical Performance Characteristics ((T<sub>J</sub> = 25 °C, unless otherwise noted))

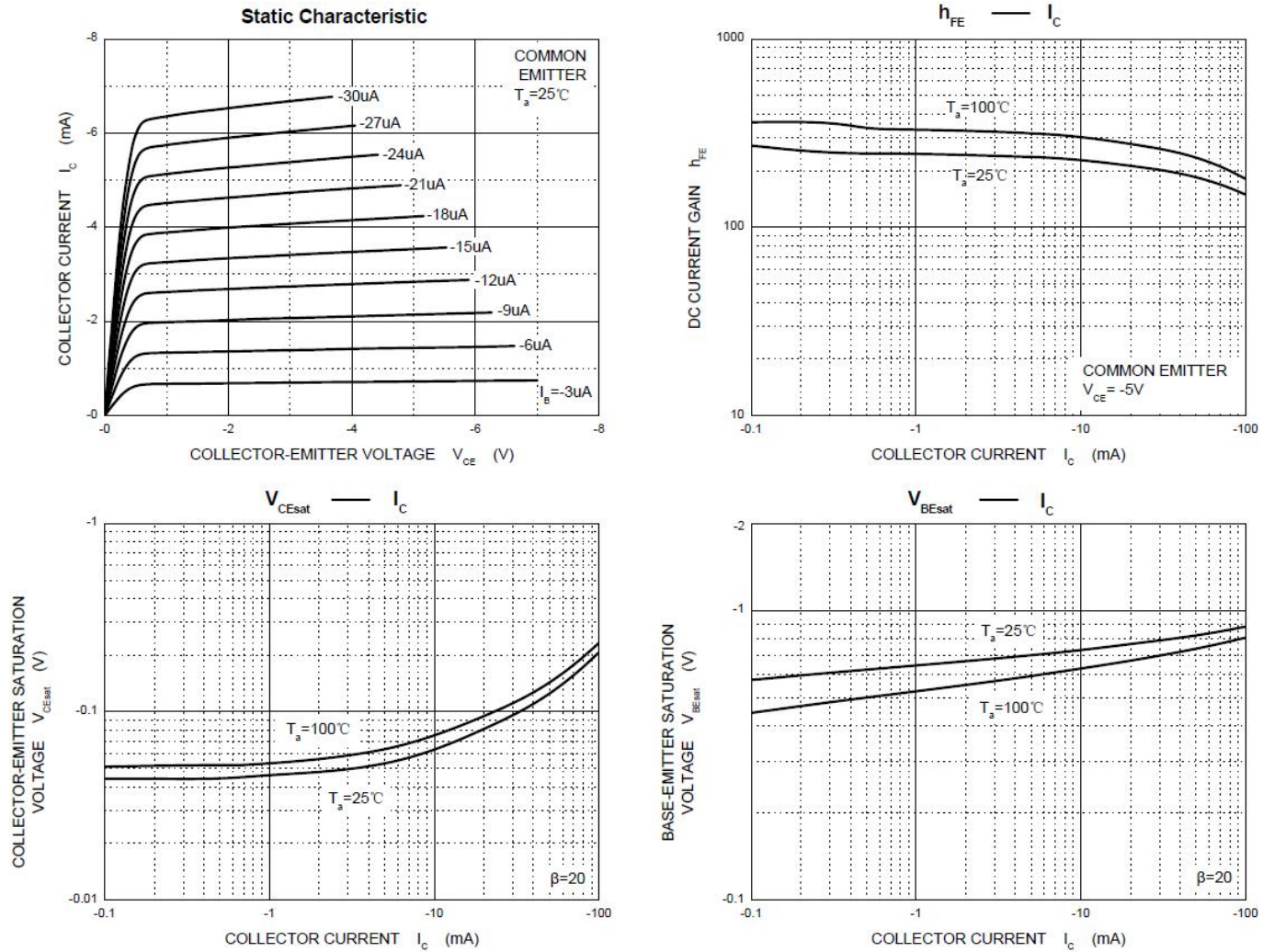

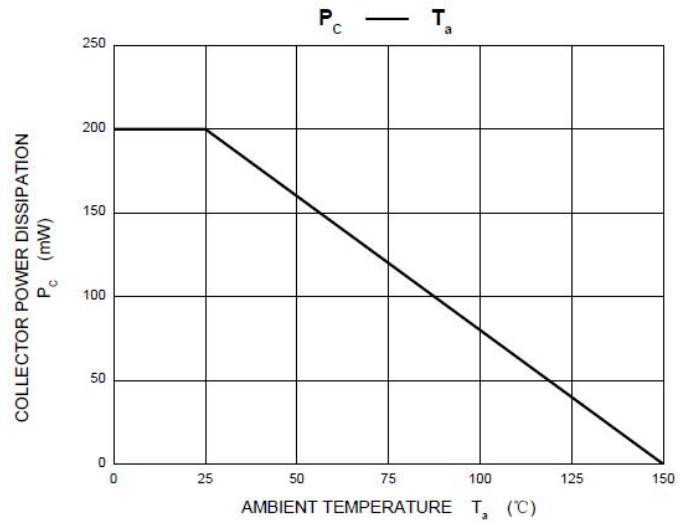
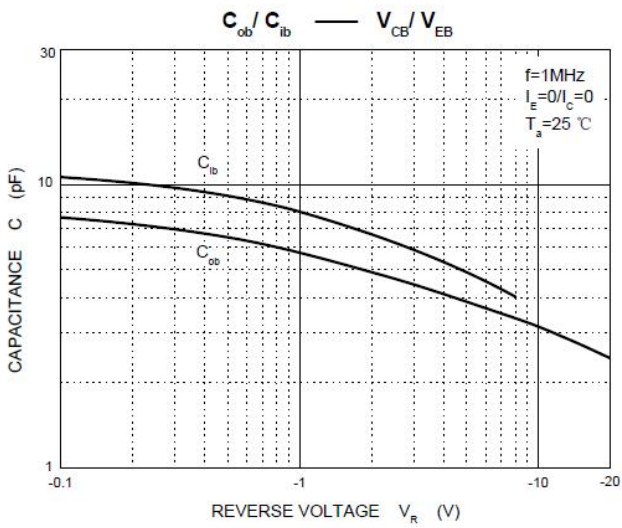
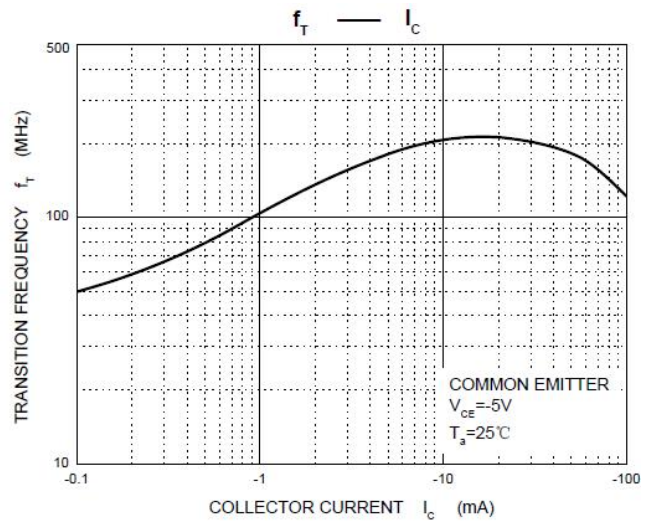
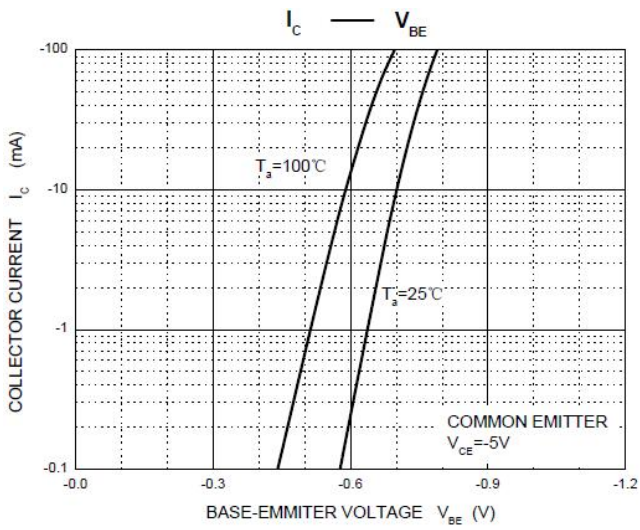

»Package Information-SOT23

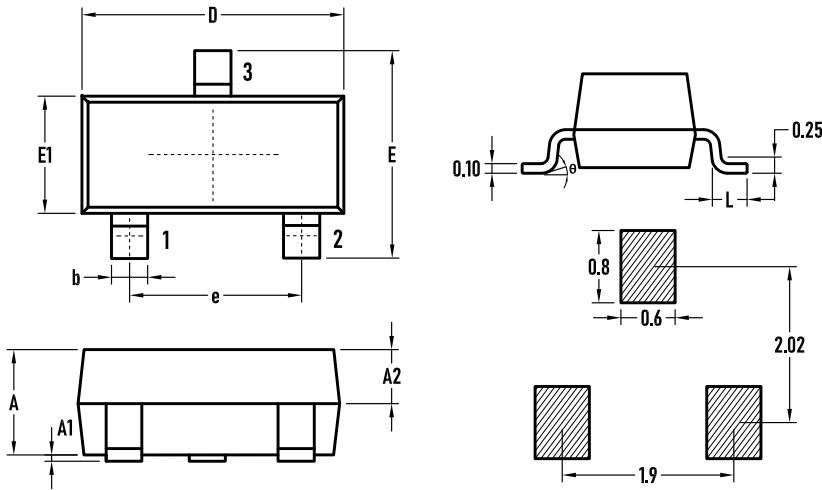

SYMBOL	MILLIMETER		
	MIN.	Typ	MAX
A	0.90	1.00	1.10
A1	0.02	0.06	0.10
A2	–	0.60	–
D	2.85	2.90	2.95
b	0.37	0.40	0.43
E	2.35	2.40	2.45
E1	1.25	1.30	1.35
e	1.85	1.90	1.95
L	0.35	0.40	0.48
θ	0	–	6°

»Marking

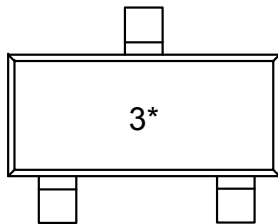

BC856A=3A BC856B=3B BC856C=3C  
 BC857A=3E BC857B=3F BC857C=3G  
 BC858A=3J BC858B=3K BC858C=3L

»Ordering information

Order code	Package	Base qty	Delivery mode
BC856 BC857 BC858	SOT-23	3K	Tape and reel

## X-ON Electronics

Largest Supplier of Electrical and Electronic Components

*Click to view similar products for [Bipolar Transistors - BJT category](#):*

*Click to view products by [Bourne manufacturer](#):*

Other Similar products are found below :

[BC559C](#) [MCH4017-TL-H](#) [MMBT-2369-TR](#) [BC546/116](#) [NJVMJD148T4G](#) [NTE16](#) [NTE195A](#) [IMX9T110](#) [2N4401-A](#) [2N4403](#) [2N6728](#)  
[2SA1419T-TD-H](#) [2SA2126-E](#) [2SB1204S-TL-E](#) [FMC5AT148](#) [2N2369ADCSM](#) [2N2907A](#) [2N3904-NS](#) [2N5769](#) [2SC4618TLN](#) [CPH6501-](#)  
[TL-E](#) [MCH4021-TL-E](#) [Jantx2N5416](#) [US6T6TR](#) [BAX18/A52R](#) [BC556/112](#) [IMZ2AT108](#) [MMST8098T146](#) [UMX21NTR](#) [MCH6102-TL-E](#)  
[TTA1452B,S4X\(S](#) [2N3879](#) [NTE13](#) [NTE282](#) [NTE323](#) [NTE350](#) [NTE81](#) [JANTX2N2920L](#) [JANTX2N3735](#) [JANSR2N2222AUB](#)  
[CMLT3946EG TR](#) [SNSS40600CF8T1G](#) [CMLT3906EG TR](#) [GRP-DATA-JANS2N2907AUB](#) [GRP-DATA-JANS2N2222AUA](#)  
[MMDT3946FL3-7](#) [2N4240](#) [MSB30KH-13](#) [2N2221AUB](#) [2SD1815T-TL-E](#)