

»Features

- 45Watts peak pulse power ($t_p = 8/20\mu s$)
- Tiny DFN2010 package
- Protect up to 4-lines
- Solid-state silicon-avalanche technology
- Low clamping voltage
- Low leakage current
- Low capacitance ($C_j = 0.28pF$ typ. I/O to I/O)
- IEC 61000-4-2 $\pm 12kV$ contact $\pm 15kV$ air
- IEC 61000-4-4 (EFT) 40A(5/50ns)
- IEC 61000-4-5 (Lightning) 3.5A(8/20 μs)

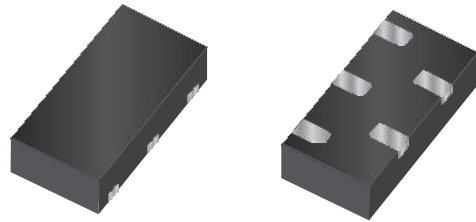

»Applications

- USB 3.0/3.1, Type C
- HDMI 1.4/2.0, Display Port 1.3
- Unified Display interface
- Digital visual interface

»Mechanical Data

- DFN2010 package
- Molding compound flammability rating: UL 94V-0
- Packaging: Tape and Reel
- RoHS/WEEE Compliant

»Schematic & PIN Configuration

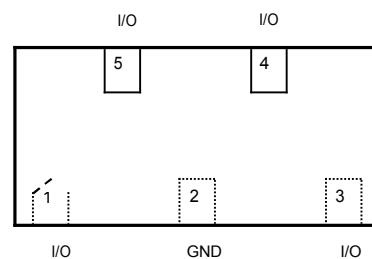
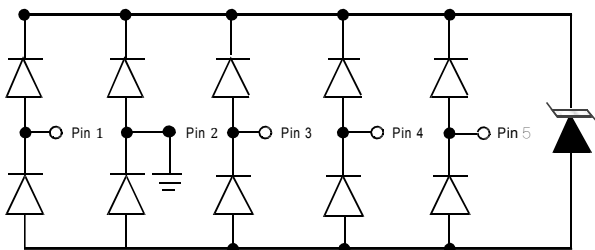

»Absolute Maximum Rating

Rating	Symbol	Value	Units
Peak Pulse Power ($t_p = 8/20\mu s$)	P_{PP}	45	Watts
Peak Pulse Current ($t_p = 8/20\mu s$)(note1)	I_{PP}	3.5	A
ESD per IEC 61000-4-2 (Air) ESD per IEC 61000-4-2 (Contact)	V_{ESD}	15 12	kV
Lead Soldering Temperature	T_L	260(10seconds)	°C
Junction Temperature	T_J	-55 to + 125	°C
Storage Temperature	T_{stg}	-55 to + 125	°C

»Electrical Characteristics

Parameter	Symbol	Conditions	Min	Typical	Max	Units
Reverse Stand-Off Voltage	V_{RWM}				5.0	V
Reverse Breakdown Voltage	V_{BR}	$I_T = 1mA$	6.0	7.2	9.5	V
Reverse Leakage Current	I_R	$V_{RWM} = 5V, T = 25^\circ C$		0.1	0.5	μA
Peak Pulse Current	I_{PP}	$t_p = 8/20\mu s$			3.5	A
Clamping Voltage	V_C	$I_{PP} = 3.5A, t_p = 8/20\mu s$			13	V
Junction Capacitance	C_j	$V_R = 0V, f = 1MHz$ I/O to I/O		0.28	0.4	pF
		$V_R = 0V, f = 1MHz$ I/O to GND		0.28	0.4	pF

»Electrical Parameters (TA = 25°C unless otherwise noted)

Symbol	Parameter
I_{PP}	Maximum Reverse Peak Pulse Current
V_C	Clamping Voltage @ I_{PP}
V_{RWM}	Working Peak Reverse Voltage
I_R	Maximum Reverse Leakage Current @ V_{RWM}
V_{BR}	Breakdown Voltage @ I_T
I_T	Test Current

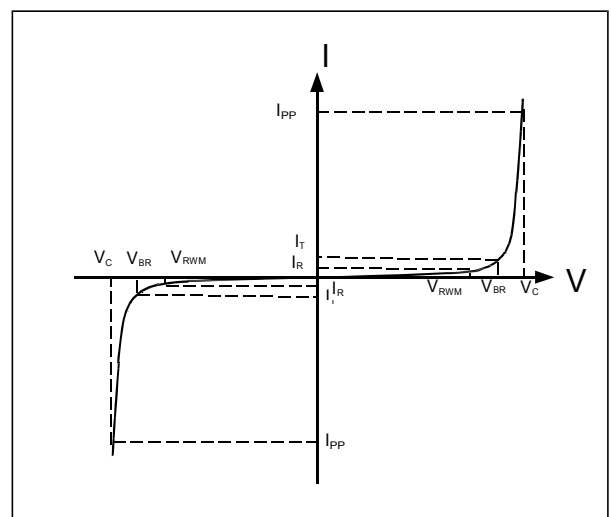

Note: 8/20 μs pulse waveform.

»Typical Characteristics

Fig.1 IEC61000-4-2 Waveform

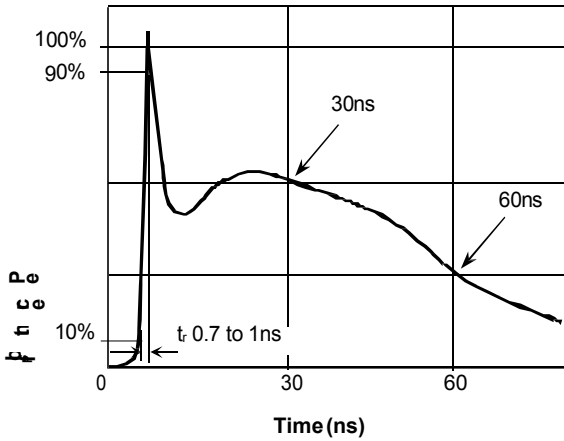

Fig.2 IEC61000-4-2 +8kV ContactESD Clamping Waveform

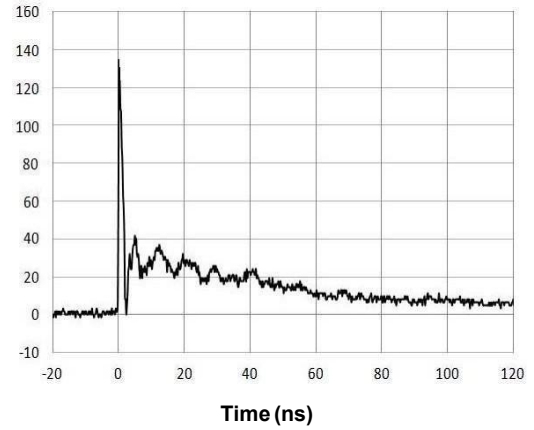

Fig.3 Eye Diagram - USB3.1 at 10Gbps per channel

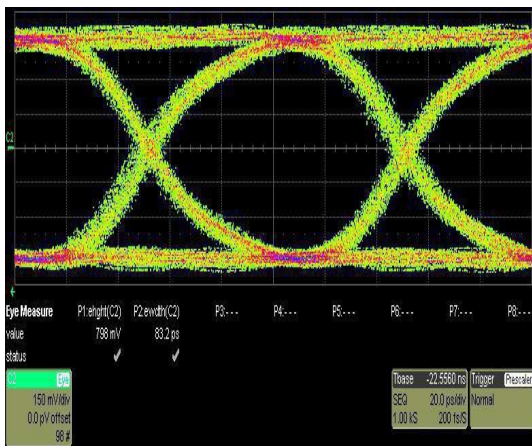
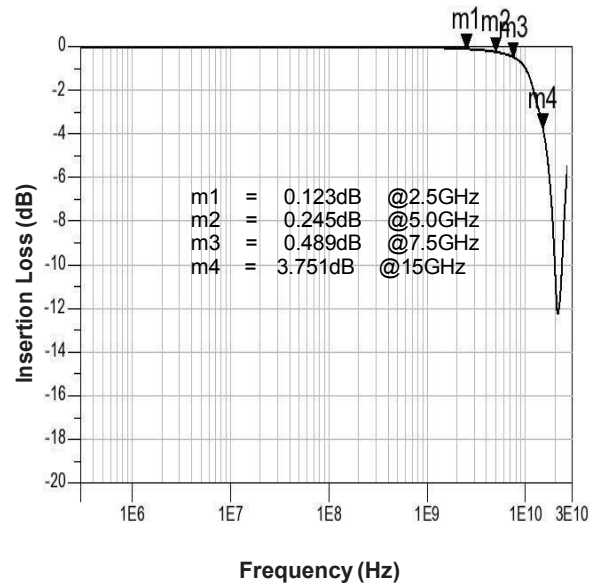
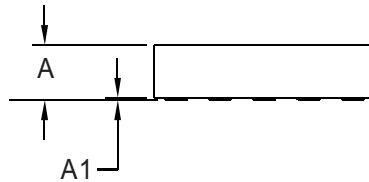
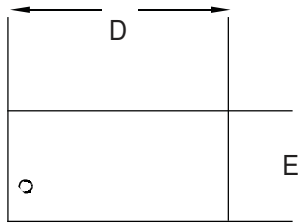

Fig.4 Insertion Loss S21 - I/O to I/O



»Outline Drawing – DFN2010



Dim	Millimeters		
	Min	Nom	Max
A	0.45	0.50	0.55
A1	0.00	0.02	0.05
b	0.15	0.20	0.25
D	1.95	2.00	2.05
E	0.95	1.00	1.05
e	0.40 BSC		
e1	0.80 BSC		
L	0.25	0.30	0.35
N	5		

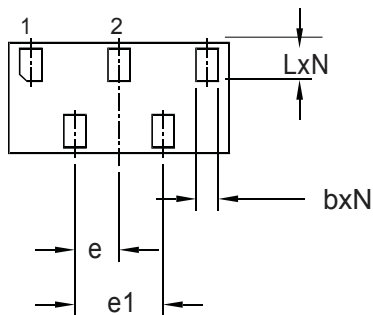

»Marking



»Ordering information

Order code	Package	Base qty	Delivery mode
BDFN2010A054R	DFN2010	3000	Tape and reel

X-ON Electronics

Largest Supplier of Electrical and Electronic Components

Click to view similar products for [ESD Suppressors / TVS Diodes](#) category:

Click to view products by [Bourne](#) manufacturer:

Other Similar products are found below :

[NTE4902](#) [P4SMAJ15A](#) [P4SMAJ26A](#) [SMAJ400CA-TP](#) [TGL34-47CA](#) [ESDAULC45-1BF4](#) [SM1605E3/TR13](#) [SMF20A-TP](#) [P4SMAJ12A](#)
[CPDUR24V-HF](#) [CPDQC5V0USP-HF](#) [CPDQC5V0-HF](#) [MPLAD30KP45CAE3](#) [MMBZ27VCLQ-7-F](#) [MMAD1108/TR13](#) [MPLAD30KP24A](#)
[ACPDQC5V0R-HF](#) [DFLT170A-7](#) [NTE4900](#) [NTE4926](#) [NTE4938](#) [SMF22A-TP](#) [SMF12A-TP](#) [SLVU2.8-TP](#) [SMLJ6.5CA-TP](#) [SMAJ6.5CA-TP](#)
[MMAD1108E3/TR13](#) [D5V0M1U2LP3-7](#) [SMAJ400A-TP](#) [AOZ8811DT-03](#) [AOZ8831DI-05](#) [AOZ8831DT-03](#) [SMAJ188CA](#) [3SMC33CA](#)
[BK](#) [CPDQC3V3C-HF](#) [CPDQC12VE-HF](#) [MPLAD30KP170CA](#) [82357120100](#) [5.0SMLJ15CA-TP](#) [5KP18A-TP](#) [P6KE8.2A-TP](#)
[MPLAD30KP43CAE3](#) [SMAJ43A-TP](#) [D5V0F6U8LP33-7](#) [TVS5501V10MUT5G](#) [5.0SMLJ24CA-TP](#) [SMAJ110CA-TP](#) [MPLAD15KP75CAE3](#)
[MMAD1103e3/TR13](#) [DFLT40AQ-7](#)