

# BNLPESD5V0S1BA

ESD Protection Diode

## Features

- 120Watts peak pulse power (tp = 8/20μs)
- Bidirectional configurations
- Solid-state silicon-avalanche technology
- Low clamping Voltage
- Low leakage current
- Protection one data/power line
- IEC 61000-4-2 ±30kV contact ; ±30kV air
- IEC 61000-4-4 (EFT) 40A (5/50ns)
- IEC 61000-4-5 (Lightning) 8A (8/20μs)

## Package

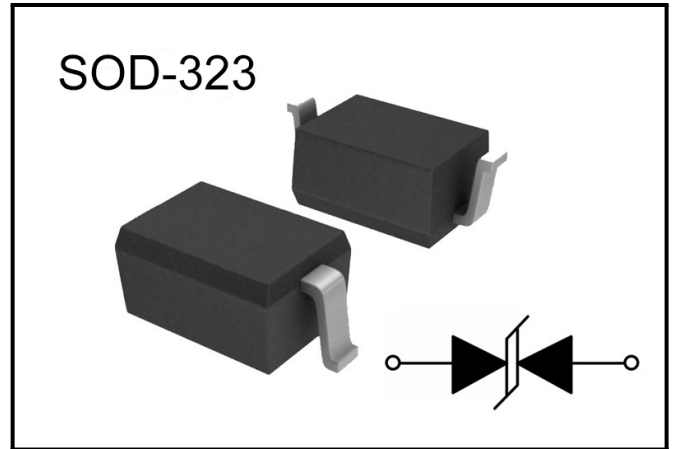

## Applications

- Microprocessor based equipment
- Personal Digital Assistants (PDA's)
- Notebooks, Desktops, and Servers
- Portable Instrumentation
- Pagers Peripherals

## Mechanical Characteristics

- SOD-323 package
- Molding compound flammability rating: UL 94V-0
- Packaging: Tape and Reel
- RoHS/WEEE Compliant

## Marking



## Ordering information

Order code	Package	Base qty	Delivery mode
BNLPESD5V0S1BA	SOD-323	3k	Tape and reel



### Electrical Parameters ( $T_A = 25^\circ\text{C}$ unless otherwise noted)

Symbol	Parameter
$I_{PP}$	Maximum Reverse Peak Pulse Current
$V_C$	Clamping Voltage @ $I_{PP}$
$V_{RWM}$	Peak Reverse Working Voltage
$I_R$	Reverse Leakage Current @ $V_{RWM}$
$V_{BR}$	Breakdown Voltage @ $I_T$
$I_T$	Test Current

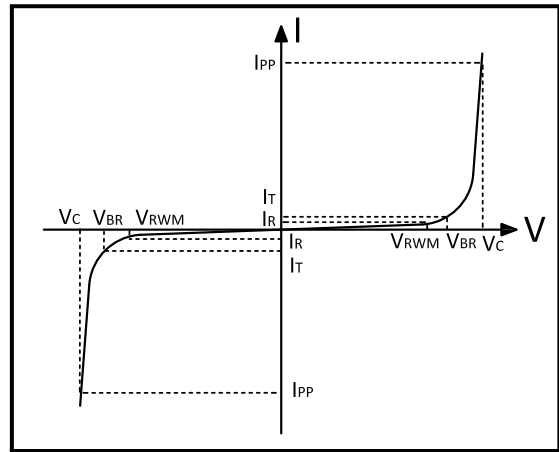

Note: 8/20us pulse Waveform.

### Absolute Maximum Rating

Rating	Symer	Value	Units
Peak Pulse Power ( $t_p = 8/20\mu\text{s}$ )	$P_{PP}$	120	Watts
Peak Pulse Current ( $t_p = 8/20\mu\text{s}$ )	$I_{PP}$	8	A
ESD per IEC 61000-4-2 (Air)	$V_{ESD}$	30	KV
ESD per IEC 61000-4-2 (Contact)		30	
Lead Soldering Temperature	$T_L$	260(10seconds)	$^\circ\text{C}$
Junction Temperature	$T_J$	-55 to + 150	$^\circ\text{C}$
Storage Temperature	$T_{stg}$	-55 to + 150	$^\circ\text{C}$

### Electrical Characteristics

Parameter	Symer	Conditions	Min	Typical	Max	Units
Reverse Stand-Off Voltage	$V_{RWM}$	-	-	-	5.0	V
Reverse Breakdown Voltage	$V_{BR}$	$I_T = 1\text{mA}$	6.0	7.5	9.5	V
Reverse Leakage Current	$I_R$	$V_{RWM} = 5\text{V}, T = 25^\circ\text{C}$	-	-	0.2	$\mu\text{A}$
Clamping Voltage	$V_C$	$I_{PP} = 8\text{A}, t_p = 8/20\mu\text{s}$	-	11	15	V
Junction Capacitance	$C_j$	$V_R = 0\text{V}, T = 25^\circ\text{C}, f = 1\text{MHZ}$	-	18	23	pF





# BNLPESD5V0S1BA

ESD Protection Diode

## Typical Characteristics

Figure 1: Peak Pulse Power vs. Pulse Time

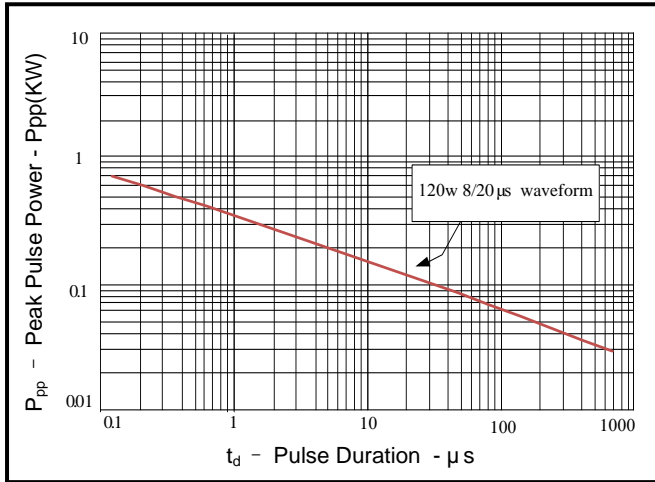

Figure 2: Power Derating Curve

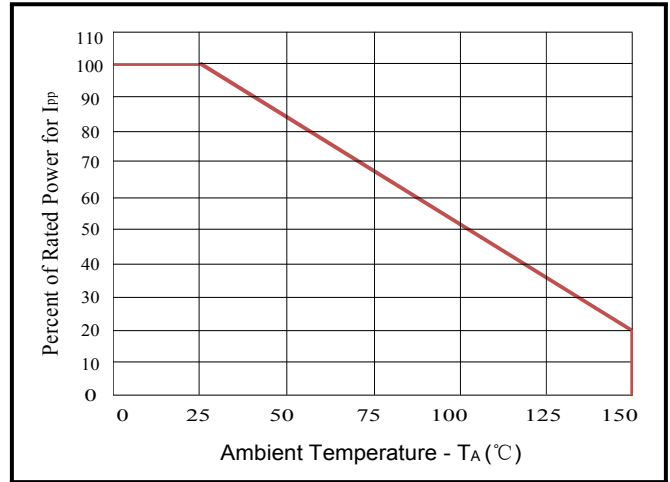

Figure 3: Pulse Waveform

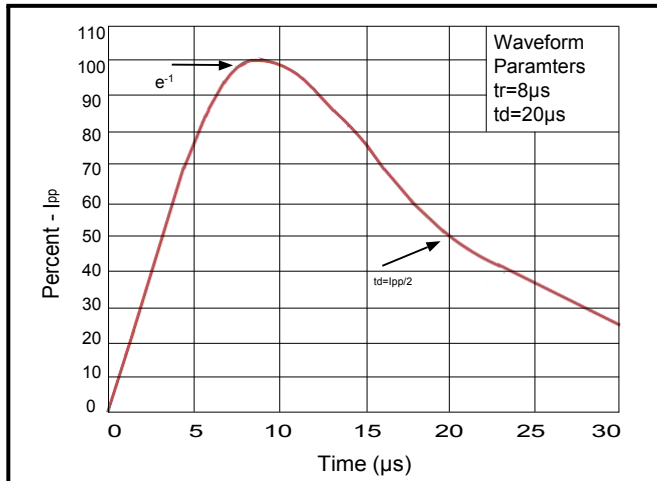
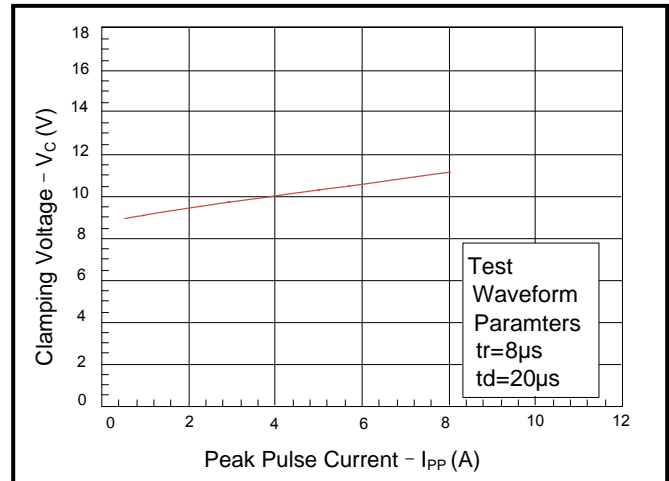

Figure 4: Clamping Voltage vs. Ipp



**BNLPESD5V0S1BA**

ESD Protection Diode

**Outline Drawing – SOD-323**

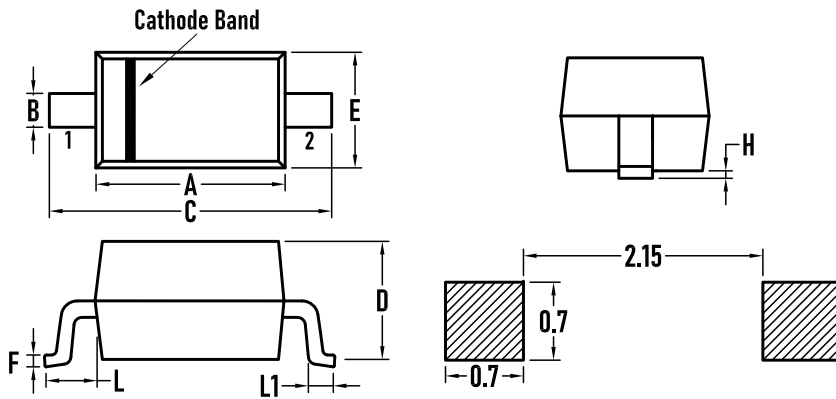

SYMBOL	MILLIMETER		INCHES	
	MIN.	MAX.	MIN.	MAX.
A	1.600	1.800	0.063	0.071
B	0.250	0.350	0.010	0.014
C	2.500	2.700	0.098	0.106
D	–	1.000	–	0.039
E	1.200	1.400	0.047	0.055
F	0.080	0.150	0.003	0.006
L	0.475REF		0.019REF	
L1	0.250	0.400	0.010	0.016
H	0.000	0.100	0.000	0.004

**Packaging Tape - SOD-323**

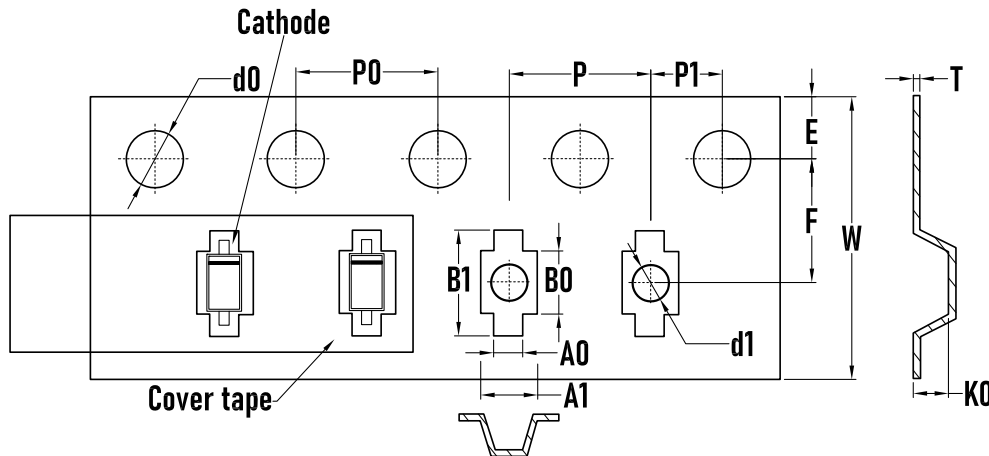

SYMBOL	MILLIMETER
A0	0.80±0.10
A1	1.48±0.10
B0	1.80±0.10
B1	3.00±0.10
d0	1.55±0.10
d1	1.00±0.05
E	1.75±0.10
F	3.50±0.10
K0	1.05±0.10
P	4.00±0.10
P0	4.00±0.10
P1	2.00±0.10
W	8.00±0.30
T	0.25 ±0.05

**Packaging Reel**

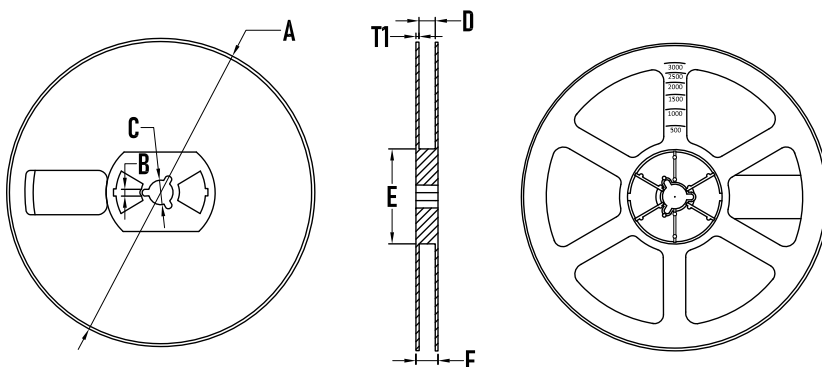

SYMBOL	MILLIMETER
A	177.8±0.2
B	2.7±0.2
C	13.5±0.2
D	9.6±0.3
E	54.5±0.2
F	12.3±0.3
T1	1.0±0.2
Quantity	3000PCS

**BORN SEMICONDUCTOR, INC. ALL  
RIGHT RESERVED**

Specifications are subject to change without notice.

Please refer to <http://www.born-tw.com> for current information.

Revision: 2022-Jan-1-A



## X-ON Electronics

Largest Supplier of Electrical and Electronic Components

*Click to view similar products for [ESD Suppressors / TVS Diodes](#) category:*

*Click to view products by [Bourne](#) manufacturer:*

Other Similar products are found below :

[60KS200C](#) [D18V0L1B2LP-7B](#) [D5V0F4U5P5-7](#) [NTE4902](#) [P4KE27CA](#) [P6KE11CA](#) [P6KE8.2A](#) [JANTX1N6053A](#) [SA60CA](#) [SA64CA](#)  
[SMBJ12CATR](#) [SMBJ33CATR](#) [SMBJ6.5A](#) [SMBJ8.0A](#) [ESD101-B1-02ELS E6327](#) [ESD112-B1-02EL E6327](#) [ESD7451N2T5G](#) [19180-510](#)  
[CPDT-5V0USP-HF](#) [3.0SMCJ33CA-F](#) [3.0SMCJ36A-F](#) [HSPC16701B02TP](#) [JANTX1N6126A](#) [D3V3Q1B2DLP3-7](#) [D55V0M1B2WS-7](#)  
[SCM1293A-04SO](#) [ESD200-B1-CSP0201 E6327](#) [SM12-7](#) [CEN955 W/DATA](#) [VESD12A1A-HD1-GS08](#) [CPDQC5V0-HF](#) [D1213A-01LP4-7B](#)  
[ESD101-B1-02EL E6327](#) [AOZ8808DI-03](#) [5KP15A](#) [5KP48A](#) [5KP90A](#) [ESD3V3D7-TP](#) [15KPA36A-LF](#) [P4KE56CA](#) [P4KE68A](#)  
[P4KE91CATR](#) [P6KE120A](#) [P6KE13CA](#) [P6KE43CA](#) [P6KE6.8CA](#) [P6KE8.2](#) [P6SMBJ20CA](#) [JANTX1N6072A](#) [SR2835ESKG](#)