

### »Features

- 220Watts peak pulse power ( $t_p = 8/20\mu s$ )
- Bidirectional configurations
- Solid-state silicon-avalanche technology
- Low clamping voltage
- Low leakage current
- IEC 61000-4-2  $\pm 30kV$  contact  $\pm 30kV$  air
- IEC 61000-4-4 (EFT) 40A (5/50ns)
- IEC 61000-4-5 (Lightning) 5.5A (8/20 $\mu s$ )

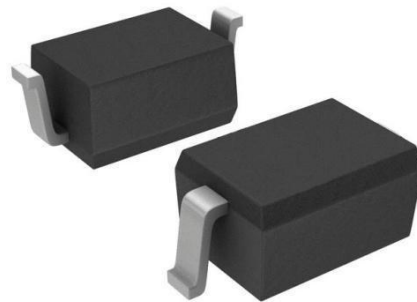

### »Applications

- Microprocessor based equipment
- Personal Digital Assistants (PDA's)
- Notebooks, Desktops, and Servers
- Portable Instrumentation
- Pagers Peripherals

### »Mechanical Data

- SOD323 package
- Molding compound flammability rating: UL94V-0
- Packaging: Tape and Reel
- RoHS/WEEE Compliant

### »Schematic & PIN Configuration

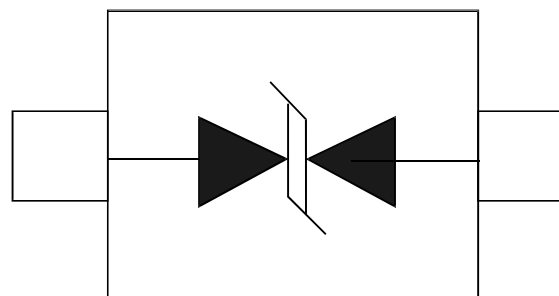

SOD-323

»Absolute Maximum Rating

Rating	Symbol	Value	Units
Peak Pulse Power ( $t_p = 8/20\mu s$ )	$P_{PP}$	220	Watts
Peak Pulse Current ( $t_p = 8/20\mu s$ ) (note1)	$I_{pp}$	5.5	A
ESD per IEC 61000-4-2 (Air) ESD per IEC 61000-4-2 (Contact)	$V_{ESD}$	30 30	kV
Lead Soldering Temperature	$T_L$	260(10seconds)	°C
Junction Temperature	$T_J$	-55 to + 150	°C
Storage Temperature	$T_{stg}$	-55 to + 150	°C

»Electrical Characteristics

Parameter	Symbol	Conditions	Min	Typical	Max	Units
Reverse Stand-Off Voltage	$V_{RWM}$				18.0	V
Reverse Breakdown Voltage	$V_{BR}$	$I_T = 1mA$	19.8			V
Reverse Leakage Current	$I_R$	$V_{RWM} = 18V, T = 25^\circ C$			0.5	$\mu A$
Clamping Voltage	$V_C$	$I_{PP} = 5.5A, t_p = 8/20\mu s$			40	V
Junction Capacitance	$C_j$	$V_R = 0V, f = 1MHz$		12		pF

»Electrical Parameters (TA = 25°C unless otherwise noted)

Symbol	Parameter
$I_{PP}$	Maximum Reverse Peak Pulse Current
$V_C$	Clamping Voltage @ $I_{PP}$
$V_{RWM}$	Working Peak Reverse Voltage
$I_R$	Maximum Reverse Leakage Current @ $V_{RWM}$
$V_{BR}$	Breakdown Voltage @ $I_T$
$I_T$	Test Current

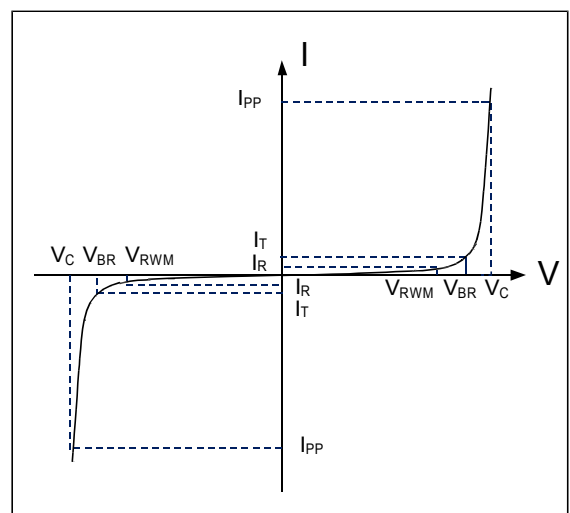

Note: 8/20 $\mu s$  pulse waveform.

»Typical Characteristics

**Figure 1: Peak Pulse Power vs. Pulse Time**

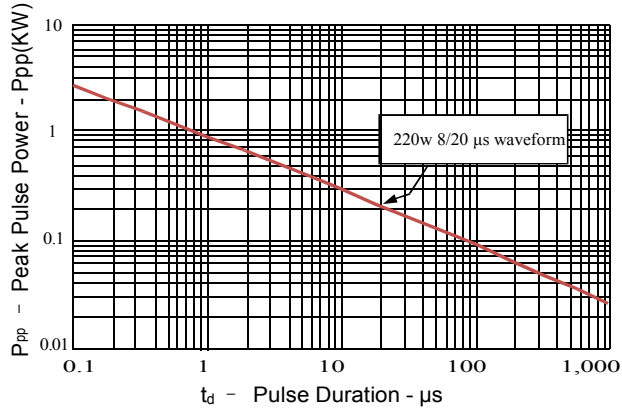

**Figure 2: Power Derating Curve**

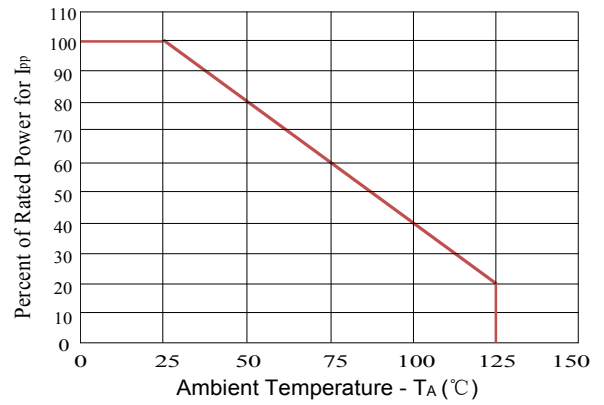

**Figure3: Pulse Waveform**

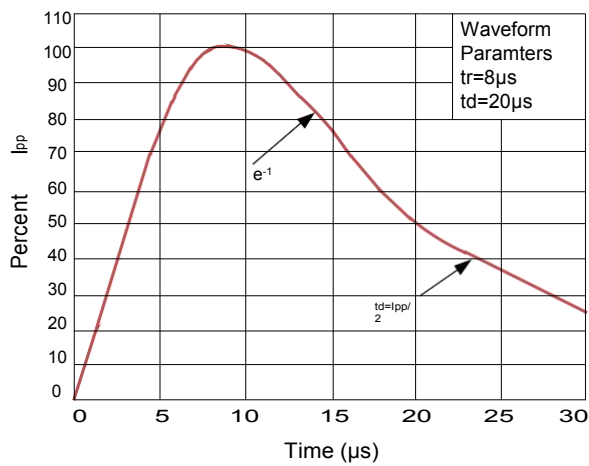

**Figure 4: Clamping Voltage vs.Ipp**

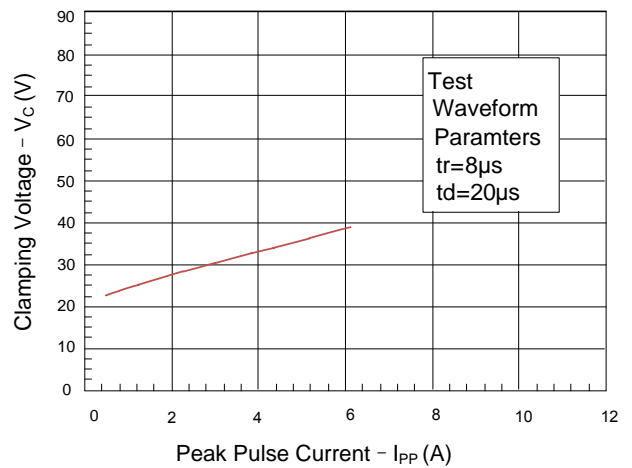

»Outline Drawing – SOD323

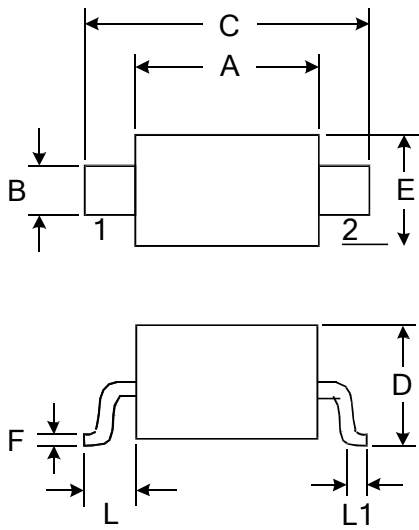

DIMENSIONS				
SYMBOL	MILLIMETER		INCHES	
	MIN	MAX	MIN	MAX
A	1.600	1.800	0.063	0.071
B	0.250	0.350	0.010	0.014
C	2.500	2.700	0.098	0.106
D		1.000		0.039
E	1.200	1.400	0.047	0.055
F	0.080	0.150	0.003	0.006
L	0.475 REF		0.019REF	
L1	0.250	0.400	0.010	0.016
H	0.000	0.100	0.000	0.004

»Marking



»Ordering information

Order code	Package	Base qty	Delivery mode
BSD3C181V	SOD323	3000	Tape and reel

## X-ON Electronics

Largest Supplier of Electrical and Electronic Components

*Click to view similar products for [ESD Suppressors / TVS Diodes](#) category:*

*Click to view products by [Bourne](#) manufacturer:*

Other Similar products are found below :

[NTE4902](#) [P4SMAJ15A](#) [P4SMAJ26A](#) [SMAJ400CA-TP](#) [TGL34-47CA](#) [ESDAULC45-1BF4](#) [SM1605E3/TR13](#) [SMF20A-TP](#) [P4SMAJ12A](#)  
[CPDUR24V-HF](#) [CPDQC5V0USP-HF](#) [CPDQC5V0-HF](#) [MPLAD30KP45CAE3](#) [MMBZ27VCLQ-7-F](#) [MMAD1108/TR13](#) [MPLAD30KP24A](#)  
[ACPDQC5V0R-HF](#) [DFLT170A-7](#) [NTE4900](#) [NTE4926](#) [NTE4938](#) [SMF22A-TP](#) [SMF12A-TP](#) [SLVU2.8-TP](#) [SMLJ6.5CA-TP](#) [SMAJ6.5CA-](#)  
[TP](#) [MMAD1108E3/TR13](#) [D5V0M1U2LP3-7](#) [SMAJ400A-TP](#) [AOZ8811DT-03](#) [AOZ8831DI-05](#) [AOZ8831DT-03](#) [SMAJ188CA](#) [3SMC33CA](#)  
[BK](#) [CPDQC3V3C-HF](#) [CPDQC12VE-HF](#) [MPLAD30KP170CA](#) [82357120100](#) [5.0SMLJ15CA-TP](#) [5KP18A-TP](#) [P6KE8.2A-TP](#)  
[MPLAD30KP43CAE3](#) [SMAJ43A-TP](#) [D5V0F6U8LP33-7](#) [TVS5501V10MUT5G](#) [5.0SMLJ24CA-TP](#) [SMAJ110CA-TP](#) [MPLAD15KP75CAE3](#)  
[MMAD1103e3/TR13](#) [DFLT40AQ-7](#)