

SMBJ / HSMBJ Series

Transient
Voltage Suppressor

Features

- Excellent clamping capability
- Low leakage current
- Low capacitance
- High surge capability
- Glass passivated chip
- Epoxy resin package
- Built-in strain relief
- Will not fatigue
- RoHS Compliant
- “H” Prefix is for Automotive applications, AEC-Q101 qualified

Package

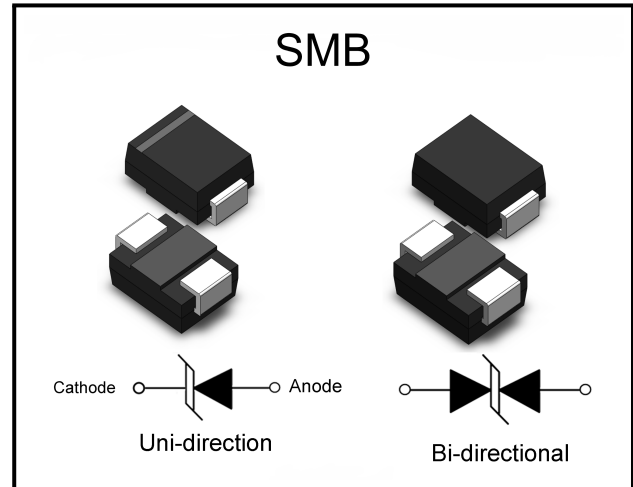

Mechanical Characteristics

- Package: SMB plastic package
- Lead Finish: Matte Tin
- Case Material: Epoxy Molding Compound
- UL Flammability Classification Rating 94V-0
- Moisture Sensitivity: Level 1 per J-STD-020

Applications

- Telecom
- Computer
- Industrial electronic
- Consumer electronic
- Automotive electronic

Making Code

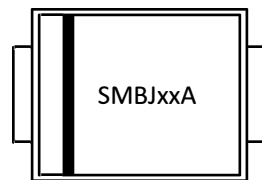

Unidirection



Bidirection

Summary of Packing Options

Package	Packing Description	Packing Quantity	Industry Standard
SMB	Tape/Reel, 13" reel	3000	EIA-481-1
	Tape/Reel, 7" reel	500	EIA-481-1

**BORN SEMICONDUCTOR, INC. ALL
RIGHT RESERVED**

Specifications are subject to change without notice.

Please refer to <http://www.born-tw.com> for current information. **Revision: 2022-Jan-1-A**



Electrical Parameters

Parameter	Definition
C_J	Junction Capacitance - typical capacitance measured with 0V or V_R bias
I_{PP}	Peak Pulse Current - maximum rated peak impulse current
V_C	Clamping Voltage - Peak voltage measured across the suppressor at a specified I_{ppm}
V_{BR}	Breakdown Voltage - Maximum voltage that flows though the TVS at a specified test current (I_T)
I_R	Leakage Current - maximum peak off-state current measured at V_R
V_R	Peak Off-state Voltage - maximum voltage that can be applied while maintaining off state

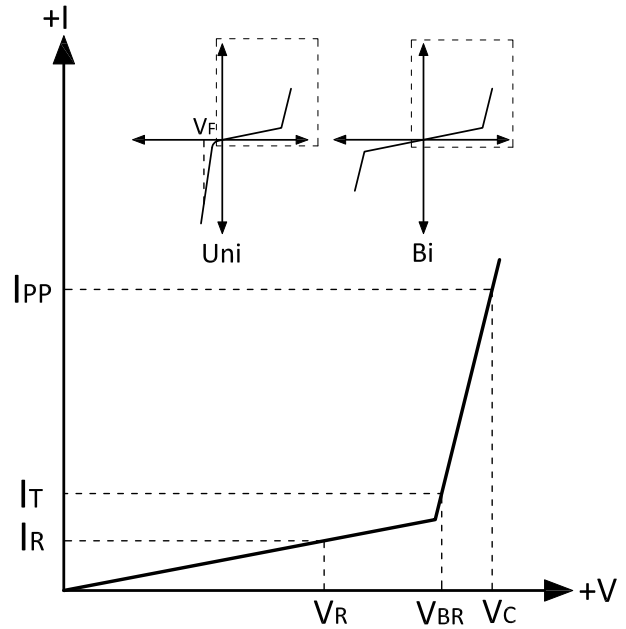

Absolute Maximum Ratings ($T_A=+25^\circ\text{C}$, unless otherwise noted)

Parameter	Symbol	Value	Units
Peak Pulse Power Dissipation (Note1,2)	P_{PPM}	600	W
Steady State Power Dissipation (Note3)	P_D	5	W
Peak Forward Surge Current (Note4)	I_{FSM}	100	A
Maximum Instantaneous Forward Voltage at 50A (Note5)	V_{FM}	3.5/5	V
Typical Thermal Resistance Junction to Lead	$R_{\theta JL}$	20	$^\circ\text{C/W}$
Typical Thermal Resistance Junction to Ambient	$R_{\theta JA}$	100	$^\circ\text{C/W}$
Operating Temperature Range	T_J	-55 to 150	$^\circ\text{C}$
Storage Temperature Range	T_{STG}	-55 to 150	$^\circ\text{C}$

Notes:

- (1) Non-repetitive current pulse , 10/1000us Waveform.
- (2) Mounted on copper pad area of 5×5mm to each terminal.
- (3) Infinite HeatSink at $T_A = 50^\circ\text{C}$
- (4) Measured on 8.3ms single half sine wave or equivalent square wave, duty cycle=4 perminute maximum.
- (5) For UnidirectionalOnly, $V_{FW} < 3.5\text{V}$ for $V_{BR} \leq 200\text{V}$ and $V_{FM} < 5.0\text{V}$ for $V_{BR} \geq 201\text{V}$.



SMBJ / HSMBJ Series

Transient
Voltage Suppressor

Electrical Characteristics ($T_A=+25^\circ\text{C}$, unless otherwise noted)

Part Number	Part Number	Reverse Stand-Off Voltage	Breakdown Voltage		Test Current I_T	Maximum Clamping Voltage $V_C @ I_{pp}$	Maximum Peak Pulse Current I_{pp}	Maximum Reverse Leakage $I_R @ V_R$
			Min.(V)	Max.(V)				
(Uni)	(Bi)	(V)			(mA)	(V)	(A)	(μA)
SMBJ5.0A HSMBJ5.0A	SMBJ5.0CA HSMBJ5.0CA	5	6.4	7	10	9.2	65.3	800
SMBJ6.0A HSMBJ6.0A	SMBJ6.0CA HSMBJ6.0CA	6	6.67	7.37	10	10.3	58.3	800
SMBJ6.5A HSMBJ6.5A	SMBJ6.5CA HSMBJ6.5CA	6.5	7.22	7.98	10	11.2	53.6	500
SMBJ6.8A HSMBJ6.8A	SMBJ6.8CA HSMBJ6.8CA	5.8	6.45	7.14	10	10.5	58.1	500
SMBJ7.0A HSMBJ7.0A	SMBJ7.0CA HSMBJ7.0CA	7	7.78	8.6	10	12	50	200
SMBJ7.5A HSMBJ7.5A	SMBJ7.5CA HSMBJ7.5CA	7.5	8.33	9.21	1	12.9	46.6	100
SMBJ8.0A HSMBJ8.0A	SMBJ8.0CA HSMBJ8.0CA	8	8.89	9.83	1	13.6	44.2	50
SMBJ8.5A HSMBJ8.5A	SMBJ8.5CA HSMBJ8.5CA	8.5	9.44	10.4	1	14.4	41.7	20
SMBJ9.0A HSMBJ9.0A	SMBJ9.0CA HSMBJ9.0CA	9	10	11.1	1	15.4	39	10
SMBJ10A HSMBJ10A	SMBJ10CA HSMBJ10CA	10	11.1	12.3	1	17	35.3	5
SMBJ11A HSMBJ11A	SMBJ11CA HSMBJ11CA	11	12.2	13.5	1	18.2	33	1
SMBJ12A HSMBJ12A	SMBJ12CA HSMBJ12CA	12	13.3	14.7	1	19.9	30.2	1
SMBJ13A HSMBJ13A	SMBJ13CA HSMBJ13CA	13	14.4	15.9	1	21.5	28	1
SMBJ14A HSMBJ14A	SMBJ14CA HSMBJ14CA	14	15.6	17.2	1	23.2	25.9	1
SMBJ15A HSMBJ15A	SMBJ15CA HSMBJ15CA	15	16.7	18.5	1	24.4	24.6	1



SMBJ / HSMBJ Series

Transient
Voltage Suppressor

Electrical Characteristics ($T_A=+25^{\circ}\text{C}$, unless otherwise noted)

Part Number	Part Number	Reverse Stand-Off Voltage	Breakdown Voltage		Test Current I_T	Maximum Clamping Voltage $V_C @ I_{pp}$	Maximum Peak Pulse Current I_{pp}	Maximum Reverse Leakage $I_R @ V_R$
			Min.(V)	Max.(V)				
(Uni)	(Bi)	(V)			(mA)	(V)	(A)	(μA)
SMBJ16A HSMBJ16A	SMBJ16CA HSMBJ16CA	16	17.8	19.7	1	26	23.1	1
SMBJ17A HSMBJ17A	SMBJ17CA HSMBJ17CA	17	18.9	20.9	1	27.6	21.8	1
SMBJ18A HSMBJ18A	SMBJ18CA HSMBJ18CA	18	20	22.1	1	29.2	20.6	1
SMBJ20A HSMBJ20A	SMBJ20CA HSMBJ20CA	20	22.2	24.5	1	32.4	18.6	1
SMBJ22A HSMBJ22A	SMBJ22CA HSMBJ22CA	22	24.4	26.9	1	35.5	16.9	1
SMBJ24A HSMBJ24A	SMBJ24CA HSMBJ24CA	24	26.7	29.5	1	38.9	15.5	1
SMBJ26A HSMBJ26A	SMBJ26CA HSMBJ26CA	26	28.9	31.9	1	42.1	14.3	1
SMBJ28A HSMBJ28A	SMBJ28CA HSMBJ28CA	28	31.1	34.4	1	45.4	13.3	1
SMBJ30A HSMBJ30A	SMBJ30CA HSMBJ30CA	30	33.3	36.8	1	48.4	12.4	1
SMBJ33A HSMBJ33A	SMBJ33CA HSMBJ33CA	33	36.7	40.6	1	53.3	11.3	1
SMBJ36A HSMBJ36A	SMBJ36CA HSMBJ36CA	36	40	44.2	1	58.1	10.4	1
SMBJ40A HSMBJ40A	SMBJ40CA HSMBJ40CA	40	44.4	49.1	1	64.5	9.3	1
SMBJ43A HSMBJ43A	SMBJ43CA HSMBJ43CA	43	47.8	52.8	1	69.4	8.7	1
SMBJ45A HSMBJ45A	SMBJ45CA HSMBJ45CA	45	50	55.3	1	72.7	8.3	1
SMBJ48A HSMBJ48A	SMBJ48CA HSMBJ48CA	48	53.3	58.9	1	77.4	7.8	1



SMBJ / HSMBJ Series

Transient
Voltage Suppressor

Electrical Characteristics ($T_A=+25^\circ\text{C}$, unless otherwise noted)

Part Number	Part Number	Reverse Stand-Off Voltage	Breakdown Voltage		Test Current I_T	Maximum Clamping Voltage $V_C @ I_{pp}$	Maximum Peak Pulse Current I_{pp}	Maximum Reverse Leakage $I_R @ V_R$
			Min.(V)	Max.(V)				
(Uni)	(Bi)	(V)			(mA)	(V)	(A)	(μA)
SMBJ51A HSMBJ51A	SMBJ51CA HSMBJ51CA	51	56.7	62.7	1	82.4	7.3	1
SMBJ54A HSMBJ54A	SMBJ54CA HSMBJ54CA	54	60	66.3	1	87.1	6.9	1
SMBJ58A HSMBJ58A	SMBJ58CA HSMBJ58CA	58	64.4	71.2	1	93.6	6.5	1
SMBJ60A HSMBJ60A	SMBJ60CA HSMBJ60CA	60	66.7	73.7	1	96.8	6.2	1
SMBJ64A HSMBJ64A	SMBJ64CA HSMBJ64CA	64	71.1	78.6	1	103	5.9	1
SMBJ70A HSMBJ70A	SMBJ70CA HSMBJ70CA	70	77.8	86	1	113	5.3	1
SMBJ75A HSMBJ75A	SMBJ75CA HSMBJ75CA	75	83.3	92.1	1	121	5	1
SMBJ78A HSMBJ78A	SMBJ78CA HSMBJ78CA	78	86.7	95.8	1	126	4.8	1
SMBJ85A HSMBJ85A	SMBJ85CA HSMBJ85CA	85	94.4	104	1	137	4.4	1
SMBJ90A HSMBJ90A	SMBJ90CA HSMBJ90CA	90	100	111	1	146	4.1	1
SMBJ100A HSMBJ100A	SMBJ100CA HSMBJ100CA	100	111	123	1	162	3.7	1
SMBJ110A HSMBJ110A	SMBJ110CA HSMBJ110CA	110	122	135	1	177	3.4	1
SMBJ120A HSMBJ120A	SMBJ120CA HSMBJ120CA	120	133	147	1	193	3.1	1
SMBJ130A HSMBJ130A	SMBJ130CA HSMBJ130CA	130	144	159	1	209	2.9	1
SMBJ150A HSMBJ150A	SMBJ150CA HSMBJ150CA	150	167	185	1	243	2.5	1





SMBJ / HSMBJ Series

**Transient
Voltage Suppressor**

Electrical Characteristics ($T_A=+25^\circ\text{C}$, unless otherwise noted)

Part Number	Part Number	Reverse Stand-Off Voltage	Breakdown Voltage		Test Current I_T	Maximum Clamping Voltage $V_C @ I_{pp}$	Maximum Peak Pulse Current I_{pp}	Maximum Reverse Leakage $I_R @ V_R$
			Min.(V)	Max.(V)				
(Uni)	(Bi)	(V)			(mA)	(V)	(A)	(μA)
SMBJ160A HSMBJ160A	SMBJ160CA HSMBJ160CA	160	178	197	1	259	2.3	1
SMBJ170A HSMBJ170A	SMBJ170CA HSMBJ170CA	170	189	209	1	275	2.2	1
SMBJ180A HSMBJ180A	SMBJ180CA HSMBJ180CA	180	201	222	1	292	2.1	1
SMBJ200A HSMBJ200A	SMBJ200CA HSMBJ200CA	200	224	247	1	324	1.9	1
SMBJ220A HSMBJ220A	SMBJ220CA HSMBJ220CA	220	246	272	1	356	1.7	1
SMBJ250A HSMBJ250A	SMBJ250CA HSMBJ250CA	250	279	309	1	405	1.5	1
SMBJ300A HSMBJ300A	SMBJ300CA HSMBJ300CA	300	335	371	1	486	1.3	1
SMBJ350A HSMBJ350A	SMBJ350CA HSMBJ350CA	350	391	432	1	567	1.1	1
SMBJ400A HSMBJ400A	SMBJ400CA HSMBJ400CA	400	447	494	1	648	0.9	1
SMBJ440A HSMBJ440A	SMBJ440CA HSMBJ440CA	440	492	543	1	713	0.9	1
SMBJ480A HSMBJ480A	SMBJ480CA HSMBJ480CA	480	536	593	1	750	0.8	1





SMBJ / HSMBJ Series

Transient Voltage Suppressor

Ratings and Characteristic Curves ($T_A = +25^\circ\text{C}$, unless otherwise noted)

Figure 1: Peak Pulse Power Rating

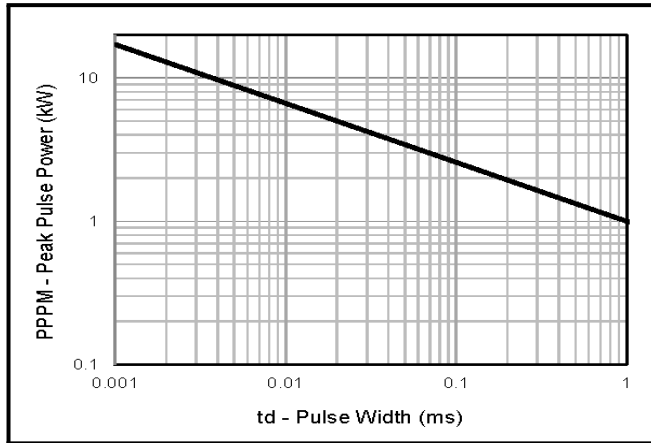

Figure 2: Pulse Derating Curve

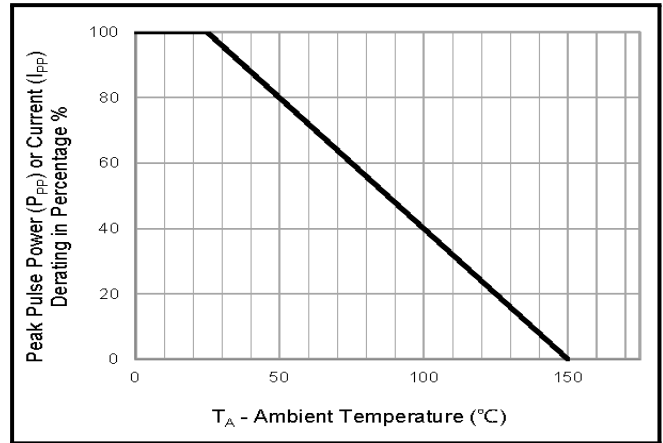

Figure 3: Pulse Waveform

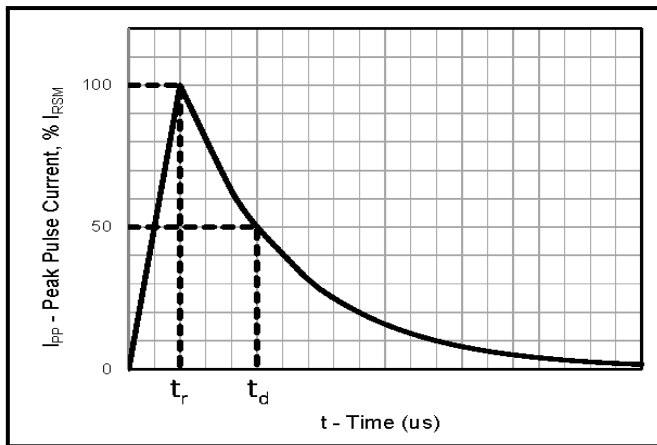

Figure 4: Typical Junction Capacitance

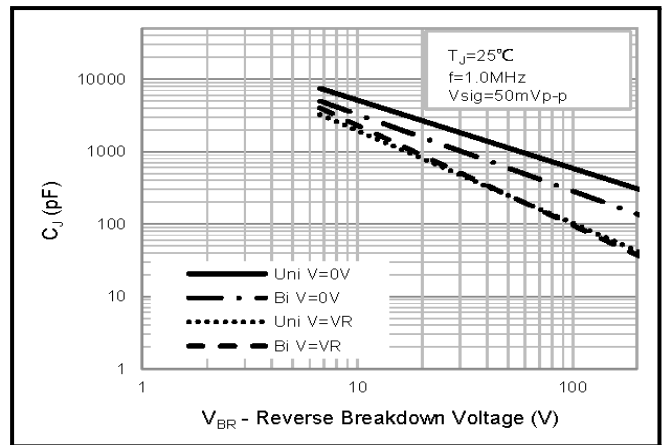

Figure 5: Steady State Power Dissipation Derating Curve

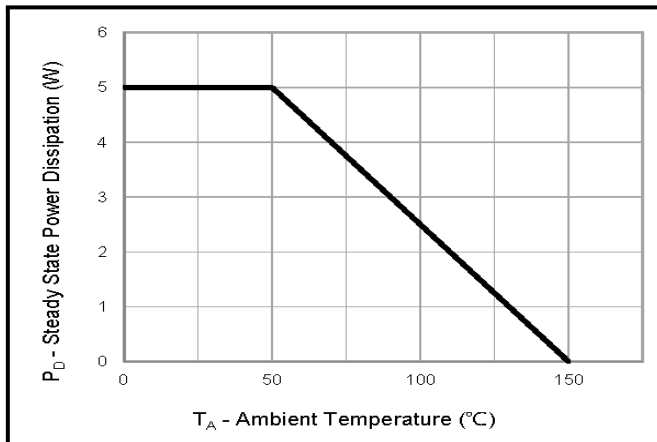
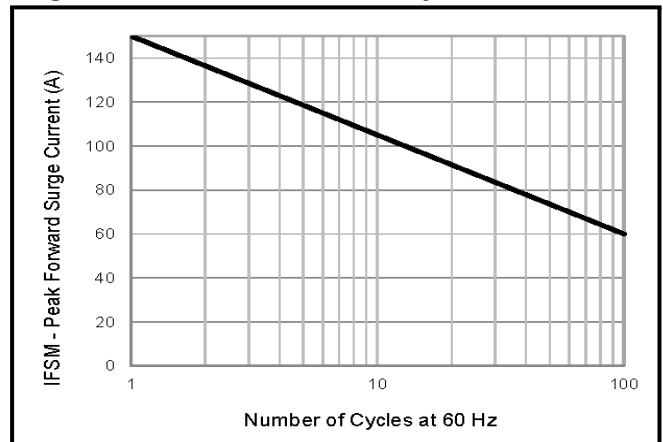
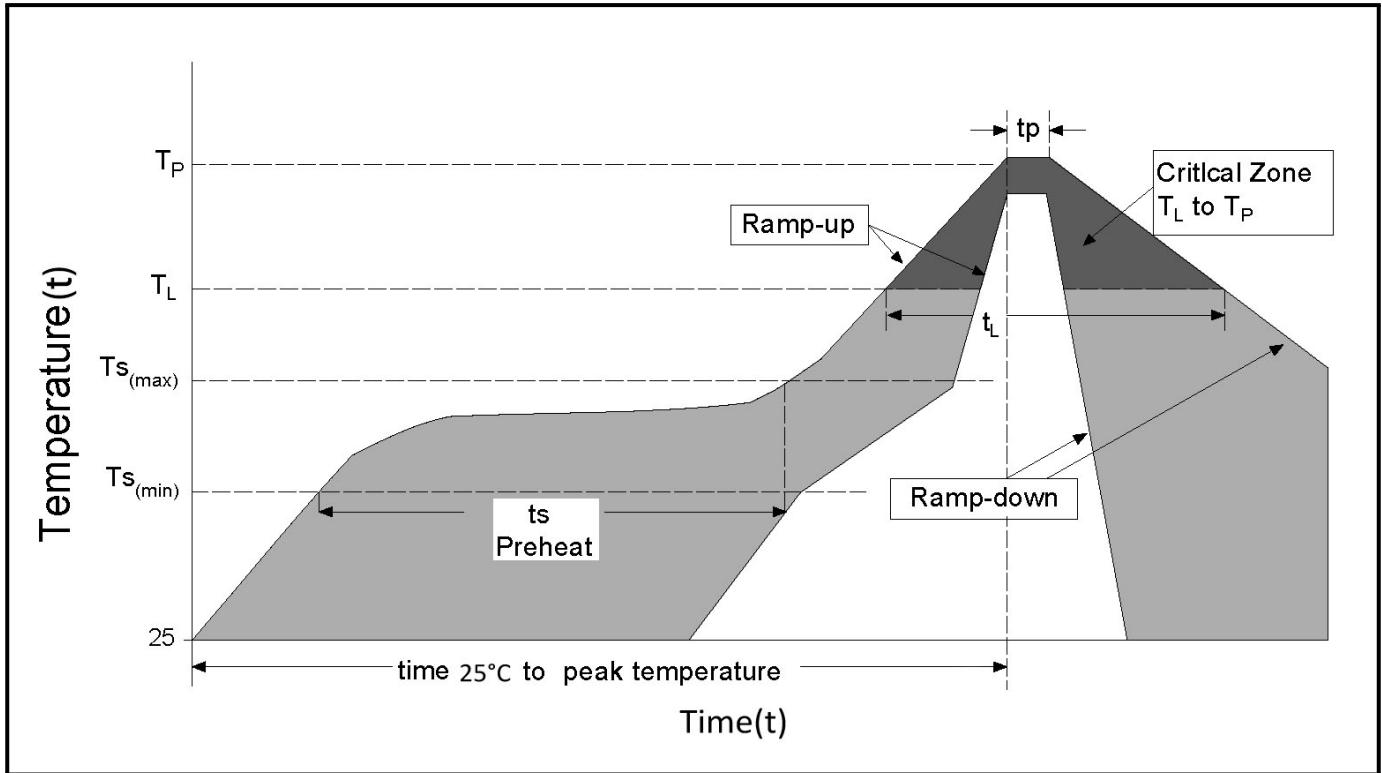

Figure 6: Maximum Non-Repetitive Peak Forward Surge Current Uni-Directional Only



Soldering Parameters



Reflow Condition		Lead-free assembly
Pre Heat	- Temperature Min ($T_{S(min)}$)	150°C
	- Temperature Max ($T_{S(max)}$)	200°C
	- Time (min to max) (t_s)	60 - 180 secs
Average ramp up rate (Liquidus Temp (T_L) to peak)		3°C/second max
$T_{S(max)}$ to T_L - Ramp-up Rate		3°C/second max
Reflow	- Temperature (T_L) (Liquidus)	217°C
	- Time (t_L)	60 -150 secs
Peak Temperature (T_P)		260 ^{+0/-5} °C
Time within 5°C of actual peak Temperature (t_p)		20 - 40 secs
Ramp-down Rate		6°C/second max
Time 25°C to peak Temperature (t)		8 minutes Max.
Do not exceed		260°C



SMBJ / HSMBJ Series

Transient
Voltage Suppressor

Outline Drawing - SMB

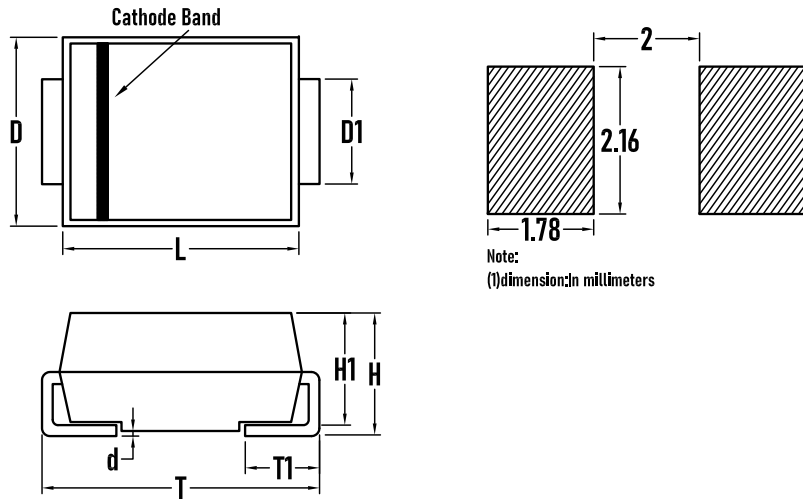

SYMBOL	MILLIMETER		Inches	
	MIN	MAX	MIN	MAX
D	3.5	3.7	0.138	0.146
D1	1.9	2.1	0.075	0.083
T	5.1	5.48	0.201	0.216
T1	1.0	1.6	0.039	0.063
d	—	0.2	—	0.008
H1	2.15	2.35	0.085	0.093
H	2.2	2.45	0.087	0.096
L	4.4	4.6	0.173	0.181

Packaging Tape - SMB

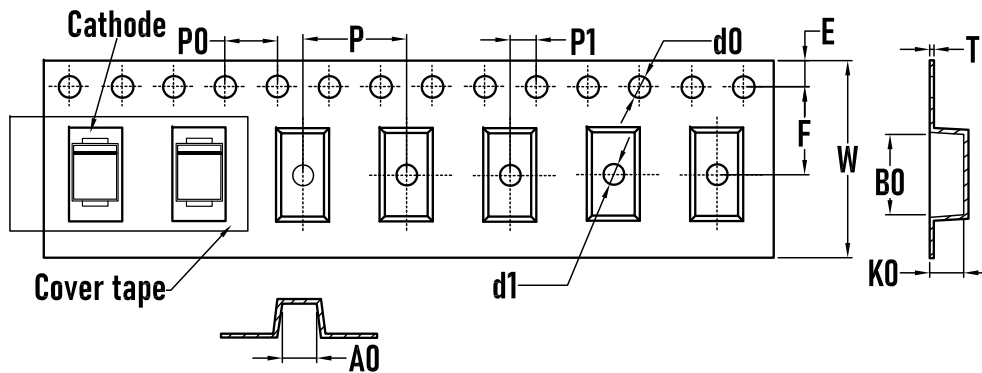

SYMBOL	MILLIMETER
A0	3.60±0.1
B0	5.45±0.1
d0	1.50±0.1
d1	1.50±0.1
E	1.75±0.1
F	5.50±0.1
K0	2.30±0.1
P	8.00±0.1
P0	4.00±0.1
P1	2.00±0.1
W	12.00±0.1
T	0.22±0.02

Packaging Reel

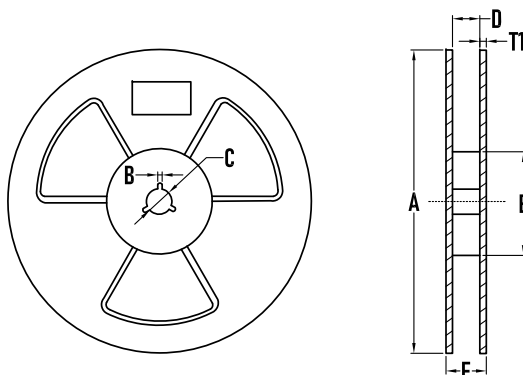

SYMBOL	MILLIMETER
A	323±2
B	3.0±0.2
C	15.0±0.5
D	13±2
E	73±2
T1	2.2±0.2
Quantity	3000PCS

**BORN SEMICONDUCTOR, INC. ALL
RIGHT RESERVED**

Specifications are subject to change without notice.

Please refer to <http://www.born-tw.com> for current information.

Revision: 2022-Jan-1-A

