

»Performance Specification

Model	Marking	V _{max} (Vdc)	I _{max} (A)	I _{hold} @25°C (A)	I _{trip} @25°C (A)	P _d Typ. (W)	Maximum		Resistance	
							Time To Trip		R _{i min} (Ω)	R _{1max} (Ω)
							Current (A)	Time (Sec)		
SMD0805-005/15N	1	15.0	30	0.05	0.15	0.5	0.5	1.50	1.500	18.000
SMD0805-010/15N	1	15.0	30	0.10	0.30	0.5	0.5	1.50	0.750	6.000
SMD0805-020/09N	2	9.0	30	0.20	0.50	0.5	8.0	0.02	0.550	3.500
SMD0805-035/06N	3	6.0	30	0.35	0.75	0.5	8.0	0.10	0.200	1.200
SMD0805-035/12N	3	12.0	30	0.35	0.75	0.5	8.0	0.10	0.200	1.200
SMD0805-050/06N	5	6.0	30	0.50	1.00	0.5	8.0	0.10	0.100	0.850
SMD0805-050/12N	5	12.0	30	0.50	1.00	0.5	8.0	0.10	0.100	0.850
SMD0805-050/16N	5	16.0	30	0.50	1.00	0.5	8.0	0.10	0.100	0.850
SMD0805-050/24N	5	24.0	30	0.50	1.00	0.5	8.0	0.10	0.100	0.850
SMD0805-075/06N	7	6.0	35	0.75	1.50	0.6	8.0	0.20	0.070	0.385
SMD0805-075/12N	7	12.0	35	0.75	1.50	0.6	8.0	0.20	0.070	0.385
SMD0805-100/06N	0	6.0	35	1.00	1.95	0.6	8.0	0.30	0.040	0.230
SMD0805-100/12N	0	12.0	35	1.00	1.95	0.6	8.0	0.30	0.040	0.230
SMD0805-110/06N	0	6.0	35	1.10	2.20	0.6	8.0	0.30	0.035	0.210
SMD0805-110/12N	0	12.0	35	1.10	2.20	0.6	8.0	0.30	0.035	0.210
SMD0805-125/06N	12	6.0	35	1.25	2.50	1.5	8.0	0.60	0.025	0.140
SMD0805-150/06N	15	6.0	35	1.50	3.00	1.0	8.0	0.50	0.015	0.130

V_{max} = Maximum operating voltage device can withstand without damage at rated current (I_{max}).

I_{max} = Maximum fault current device can withstand without damage at rated voltage (V_{max}).

I_{hold} = Hold Current. Maximum current device will not trip in 25°C still air.

I_{trip} = Trip Current. Minimum current at which the device will always trip in 25°C still air.

P_d = Power dissipation when device is in the tripped state in 25°C still air environment at rated voltage.

R_{i min/max} = Minimum/Maximum device resistance prior to tripping at 25°C.

R_{1max} = Maximum device resistance is measured one hour post reflow.

CAUTION : Operation beyond the specified ratings may result in damage and possible arcing and flame.

»Environmental Specifications

Test	Conditions	Resistance change
Passive aging	+85°C, 1000 hrs.	±5% typical
Humidity aging	+85°C, 85% R.H. , 168 hours	±5% typical
Thermal shock	+85°C to -40°C, 20 times	±33% typical
Resistance to solvent	MIL-STD-202, Method 215	No change
Vibration	MIL-STD-202, Method 201	No change
Ambient operating conditions : - 40 °C to +85 °C		
Maximum surface temperature of the device in the tripped state is 125 °C		

»Thermal Derating Chart Recommended Hold Current(A) at Ambient Temperature(°C)

Model	Ambient Operation Temperature								
	-40°C	-20°C	0°C	25°C	40°C	50°C	60°C	70°C	85°C
SMD0805-005N	0.070	0.060	0.055	0.050	0.040	0.035	0.030	0.025	0.015
SMD0805-010N	0.14	0.12	0.11	0.10	0.08	0.07	0.06	0.05	0.03
SMD0805-020N	0.28	0.25	0.23	0.20	0.17	0.14	0.12	0.10	0.07
SMD0805-035N	0.47	0.44	0.39	0.35	0.30	0.27	0.24	0.20	0.14
SMD0805-050N	0.68	0.62	0.55	0.50	0.40	0.37	0.33	0.29	0.23
SMD0805-075N	1.00	0.90	0.79	0.75	0.63	0.57	0.53	0.41	0.34
SMD0805-100N	1.35	1.25	1.15	1.00	0.82	0.74	0.65	0.55	0.42
SMD0805-110N	1.45	1.35	1.20	1.10	0.92	0.84	0.75	0.65	0.52
SMD0805-125N	1.65	1.53	1.36	1.25	1.05	0.95	0.85	0.74	0.59
SMD0805-150N	1.98	1.84	1.63	1.50	1.26	1.14	1.02	0.88	0.71

»Thermal Derating Curve

» Average Time-Current Curve

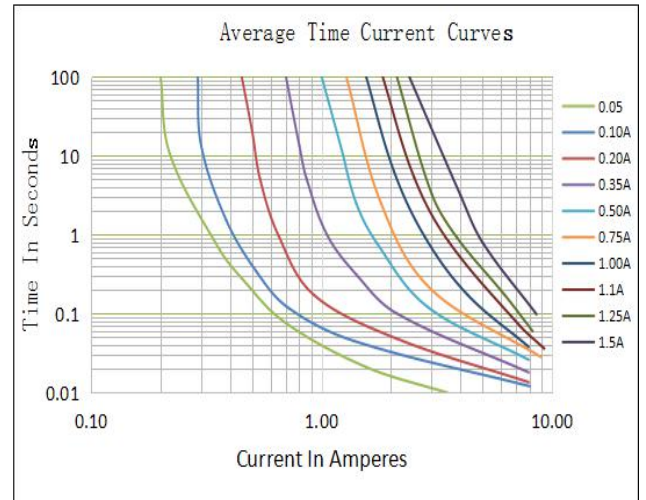
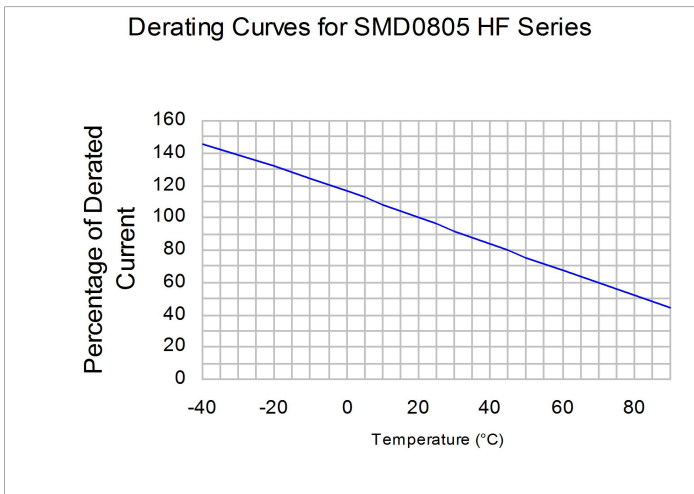

»Soldering Parameters

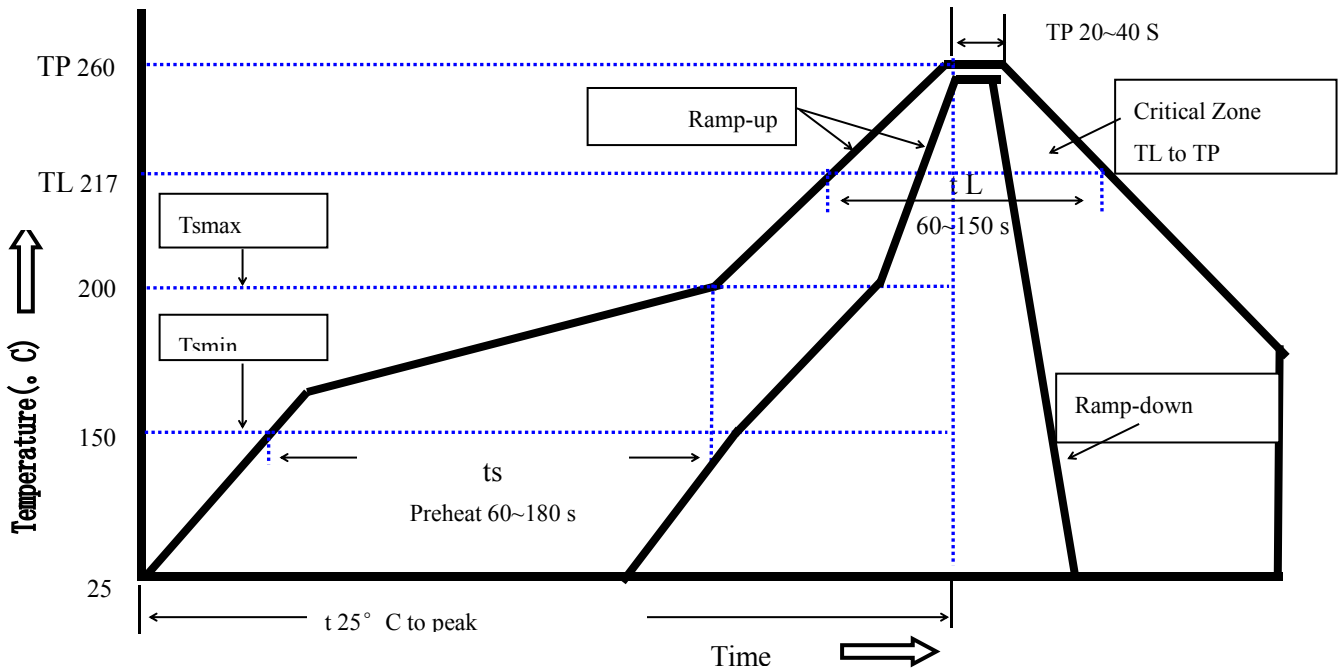

Profile Feature	Pb-Free Assembly
Average Ramp-Up Rate(Ts max to T p)	3°C/second max.
Preheat	
-Temperature Min(Ts min)	150°C
-Temperature Max(Ts max)	200°C
-Time(Ts min to Ts max)	60~180 seconds
Time maintained above:	
-Temperature(TL)	217°C
-Time(tL)	60~150 seconds
Peak Temperature(Tp)	260°C
Ramp-Down Rate	6°C/second max.
Time 25°C to Peak Temperature	8 minutes max
Storage Condition	0°C~35°C,30%-60%RH

Recommended reflow methods: IR, vapor phase oven, hot air oven, N2 environment for lead-free

Recommended maximum paste thickness is 0.25mm

Devices can be cleaned using standard industry methods and solvents.

Note 1: All temperature refer to topside of the package, measured on the package body surface.

Note 2: If reflow temperatures exceed the recommended profile, devices may not meet the performance requirements.

»Physical Dimensions(mm.)

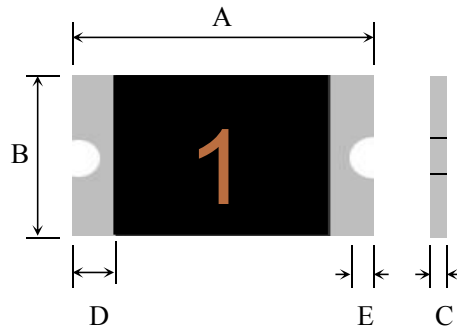

型號	A		B		C		D	E
	Min.	Max.	Min.	Max.	Min.	Max.	Min.	Min.
SMD0805-005N	2.00	2.20	1.20	1.50	0.40	0.90	0.20	0.10
SMD0805-010N	2.00	2.20	1.20	1.50	0.40	0.90	0.20	0.10
SMD0805-020N	2.00	2.20	1.20	1.50	0.35	0.80	0.20	0.10
SMD0805-035N	2.00	2.20	1.20	1.50	0.35	0.80	0.20	0.10
SMD0805-035/12N	2.00	2.20	1.20	1.50	0.35	0.80	0.20	0.10
SMD0805-050N	2.00	2.20	1.20	1.50	0.35	0.80	0.20	0.10
SMD0805-050/12N	2.00	2.20	1.20	1.50	0.35	0.80	0.20	0.10
SMD0805-050/16N	2.00	2.20	1.20	1.50	0.50	1.10	0.20	0.10
SMD0805-050/24N	2.00	2.20	1.20	1.50	0.50	1.10	0.20	0.10
SMD0805-075N	2.00	2.20	1.20	1.50	0.50	1.00	0.20	0.10
SMD0805-075/N	2.00	2.20	1.20	1.50	0.50	1.00	0.20	0.10
SMD0805-100N	2.00	2.20	1.20	1.50	0.70	1.20	0.20	0.10
SMD0805-100/12N	2.00	2.20	1.20	1.50	0.70	1.20	0.20	0.10
SMD0805-110N	2.00	2.20	1.20	1.50	0.70	1.20	0.20	0.10
SMD0805-110/12N	2.00	2.20	1.20	1.50	0.70	1.20	0.20	0.10
SMD0805-125N	2.00	2.20	1.20	1.50	1.00	1.50	0.20	0.10
SMD0805-150N	2.00	2.20	1.20	1.50	1.00	1.50	0.20	0.10

Termination Pad Characteristics

Terminal pad materials: Tin-plated Nickel-Copper

Terminal pad solder ability: Meets EIA specification RS186-9E and ANSI/J-STD-002 Category 3.

»Recommended Pad Layout (mm.)

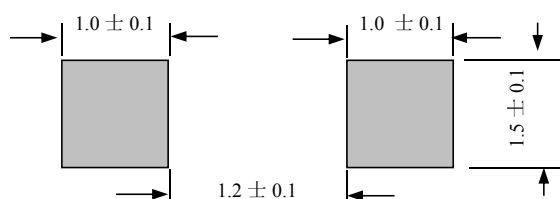

»Packaging Quantity

Part Number	Quantity
SMD0805-005.010.020.035.050	5,000 pcs/reel
SMD0805-075.100.110.125	4,000 pcs/reel
SMD0805-150	3,500 pcs/reel

Tape & reel packaging per EIA481-1

»Tape And Reel Specifications (mm)

Governing Specifications	EIA 481-1
W	8.0 ± 0.3
P0	4.0 ± 0.10
P1	4.0 ± 0.10
P2	2.0 ± 0.05
A0	1.45 ± 0.10
B0	2.30 ± 0.10
B1max.	4.35
D0	1.55 + 0.1, -0
F	3.5 ± 0.05
E1	1.75 ± 0.10
E2min.	6.25
T	0.25
T1max.	0.1
K0	0.74 ± 0.1
Leader min.	390
Trailer min.	160
Reel Dimensions	
A max.	178
N min.	60
W1	9.0 ± 0.5
W2	12.0 ± 0.05

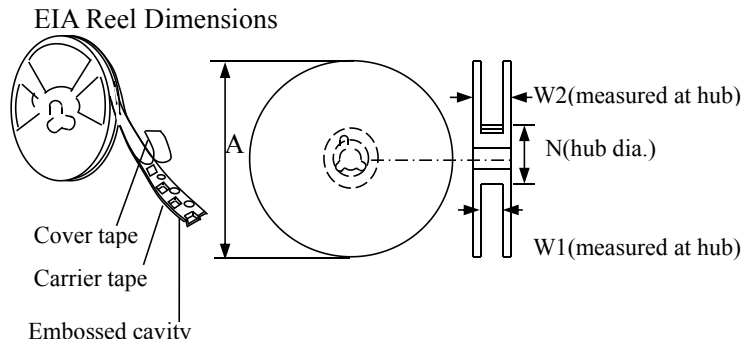
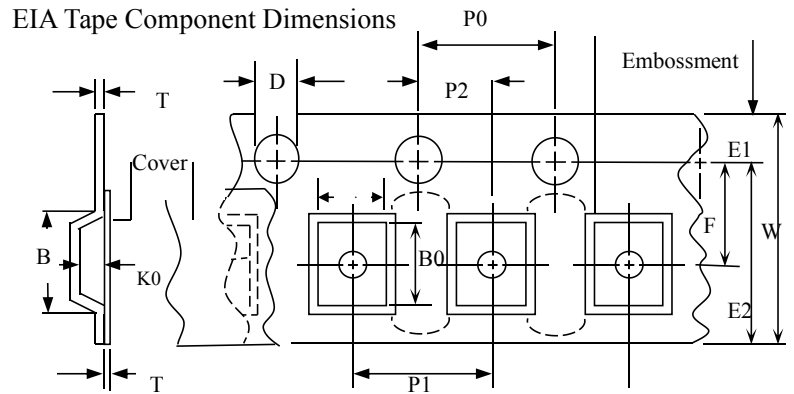

Storage And Handling

- Storage conditions: 35°C max, 30%-60% R.H.
- Devices may not meet specified performance if storage conditions are exceeded.

Part Number System

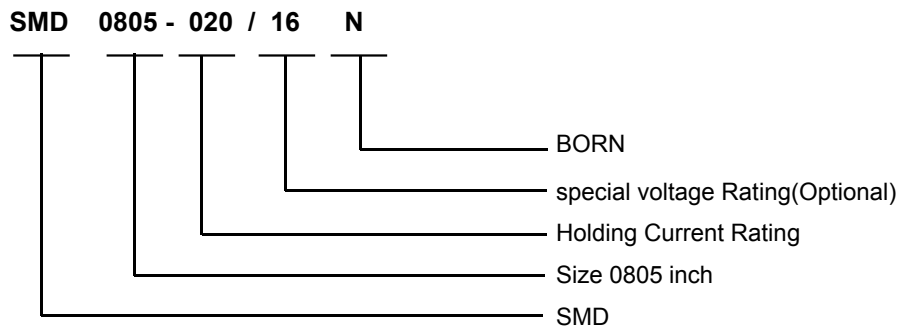

X-ON Electronics

Largest Supplier of Electrical and Electronic Components

Click to view similar products for [Resettable Fuses - PPTC category](#):

Click to view products by [Bourne manufacturer](#):

Other Similar products are found below :

[RF0077-000](#) [RF2534-000](#) [RF3256-000](#) [RF3281-000](#) [RF3301-000](#) [RF3344-000](#) [RF3382-000](#) [SMD125-2](#) [RF2171-000](#) [RF2531-000](#) [RF2873-000](#) [RF3060-000](#) [TR600-150Q-B-0.5-0.130](#) [RXE090](#) [5E4795/04-1502](#) [TRF250-080T-B-1.0-0.125](#) [SMD100-2](#) [NIS5452MT1TXG](#) [NIS5431MT1TXG](#) [SMD250-2](#) [0ZCM0001FF2G](#) [0ZCM0003FF2G](#) [0ZCM0004FF2G](#) [BK60-017-DZ-E0.6](#) [F95456-000](#) [LVR100S](#) [RS30-090](#) [RS30-600](#) [RS30-700](#) [RS30-800](#) [RS30-900](#) [RS60RB-005](#) [RS60RB-010](#) [RS60RB-020](#) [RS60RB-025](#) [RS60RB-050](#) [RS60RB-075](#) [RS60RB-160](#) [SMD1206-300C-12V](#) [KRL1200050SBY](#) [SB250-145](#) [SB250-030](#) [SB250-040](#) [SB250-200](#) [SB250-600](#) [SMD0805-005-24V](#) [SMD0805-050-16V](#) [SMD1210-005-60V](#) [SMD0805-005](#) [R60-375](#)