



Features

- RoHS compliant*
- CW or CCW rotary switch
- Linear and audio tapers
- PC board and bushing mount
- Splash seal
- Metal bushing and shaft

Applications

- Test and measurement equipment
- Avionics controls
- Communications equipment
- Medical laboratory equipment

56 – Sealed 1/2" (12.5 mm) Panel Control w/Rotary Switch

Electrical Characteristics¹

Standard Resistance Range	
Linear	1K to 500K ohms
Audio	1K to 500K ohms
Total Resistance Tolerance	
B & D Tapers	±20 %
E & S Tapers	±10 %
Independent Linearity	
Absolute Minimum Resistance	2 ohms maximum
Effective Electrical Angle	240° ±5
Contact Resistance Variation	±2 %
Dielectric Withstanding Voltage (MIL-STD-202, Method 301)	
Sea Level	1,500 VAC minimum
70,000	500 VAC minimum
Insulation Resistance	
Power Rating At 70 °C (Derate To 0 At 125 °C)	1,000 megohms minimum
(Voltage Limited By Power Dissipation or 350 VAC, Whichever Is Less)	
Linear Tapers	0.5 watt
Audio Tapers	0.25 watt
Theoretical Resolution	
	Essentially infinite

Environmental Characteristics¹

Operating Temperature Range	
	+1 °C to +125 °C
Storage Temperature Range	
	-55 °C to +125 °C
Temperature Coefficient Over Storage Temperature Range	
	±1,000 ppm/°C
Vibration	
	8 G
Total Resistance Shift	
	±2 % maximum
Voltage Ratio Shift	
	±5 % maximum
Shock	
	20 G
Total Resistance Shift	
	+2 % maximum
Voltage Ratio Shift	
	±5 % maximum
Load Life	
	1,000 hours
Total Resistance Shift	
	±10 % TRS maximum
Rotational Life (No Load)	
	50,000 cycles
Total Resistance Shift	
	±10 % TRS maximum
Contact Resistance Variation	
	±2 %
Moisture Resistance (MIL-STD-202, Method 103, Condition B)	
B & E Taper	±10 % TRS
D & S Taper	±20 % TRS
IP Rating	
Entire Unit	IP64
Shaft/Bushing	IP65

Mechanical Characteristics

Stop Strength	
	56 N-cm (5 lb.-in.)
Mechanical Angle	
	290° ±5°
Torque	
Running/Starting	0.2 to 1.3 N-cm (0.25 to 2.0 oz.-in.)
Mounting (Torque on Bushing)	1.7 to 2.0 N-m (15 to 18 lb.-in.) maximum
Weight	
	8.5 grams
Terminals	
	PC pin
Soldering Condition	
	Recommended hand soldering using Sn95/Ag5 no clean solder, 0.025" wire diameter.
	Maximum temperature 399 °C (750 °F) for 3 seconds. No wash process to be used with no clean flux.
	Part can be wave soldered at 260 °C (500 °F) for 5 seconds, no wash process with no clean flux.
Marking	
	Manufacturer's trademark, part number, resistance value and date code.
Ganging (Multiple Section Potentiometers and Switches)	
	Inquire for availability, minimum order quantity and price.
Hardware	
	Locking bushing versions are shipped with one additional locking nut (Bushing A: H-37-2 & H-38-2; Bushing C: H-37-1 & H-38-1)

¹Electrical specifications tested at 200 RPM, at room ambient: +25 °C nominal.



WARNING
Cancer and Reproductive Harm
www.P65Warnings.ca.gov

*RoHS Directive 2015/863, Mar 31, 2015 and Annex.
 Specifications are subject to change without notice. Users should verify actual device performance in their specific applications. The products described herein and this document are subject to specific legal disclaimers as set forth on the last page of this document, and at www.bourns.com/docs/legal/disclaimer.pdf.

56 – Sealed 1/2" (12.5 mm) Panel Control w/Rotary Switch



Initial Electrical Characteristics - Switch

Switch Type	SPDT (Break before make)
Power Rating (Resistive Load)	0.5 A @ 30 VDC
Dielectric Withstanding Voltage (MIL-STD-202, Method 301) Sea Level	1000 VAC minimum
Insulation Resistance	1000 megohms minimum
Contact Resistance	30 milliohms maximum
Contact Bounce	5 milliseconds maximum
Actuation Angle	35 ° maximum
Switch Travel	25 ° maximum
Detent Torque	1.3 N-cm (2.0 oz.-in) nominal

Environmental Characteristics¹

Vibration	8 G
Contact Resistance	30 milliohms maximum
Contact Bounce	0.1 milliseconds maximum
Shock	20 G
Contact Resistance	30 milliohms maximum
Contact Bounce	0.1 milliseconds maximum
Rotational Life @ Rated Power	50,000 cycles
Contact Resistance	100 milliohms maximum
Moisture Resistance (MIL-STD-202, Method 103, Condition B) Contact Resistance	30 milliohms maximum
Insulation Resistance (After 24 Hours @ Room Temperature - 500 VDC)	100 megohms minimum

¹Electrical specifications tested at 200 RPM, at room ambient: +25 °C nominal.

Hardware

LOCKWASHER H-37-1

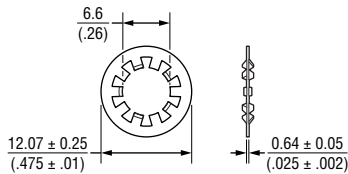

LOCKWASHER H-37-2

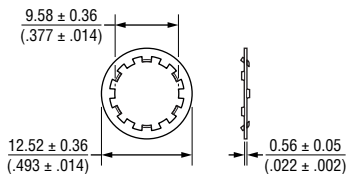

NUT H-38-1

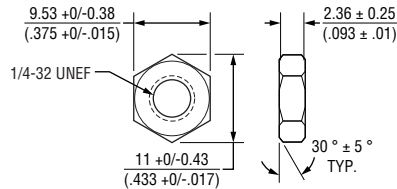

NUT H-38-2

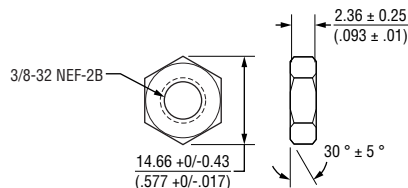

DIMENSIONS: $\frac{\text{MM}}{\text{(INCHES)}}$

Date Code Description

YY WW M

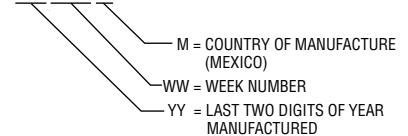

Specifications are subject to change without notice.

Users should verify actual device performance in their specific applications.

The products described herein and this document are subject to specific legal disclaimers as set forth on the last page of this document, and at www.bourns.com/docs/legal/disclaimer.pdf.

56 – Sealed 1/2" (12.5 mm) Panel Control w/Rotary Switch



Product Dimensions

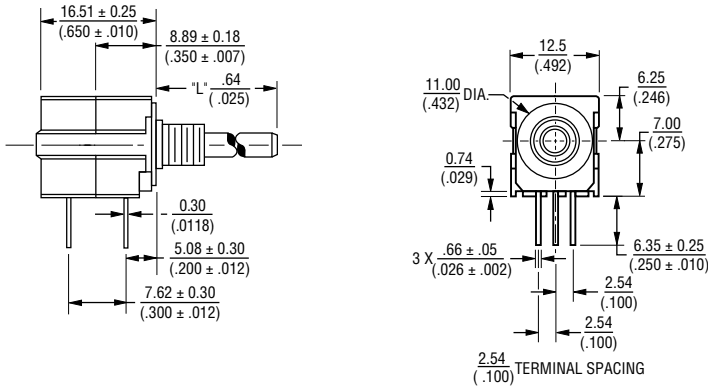

PACKAGE DIMENSIONS W/PCB MOUNTING BRACKET

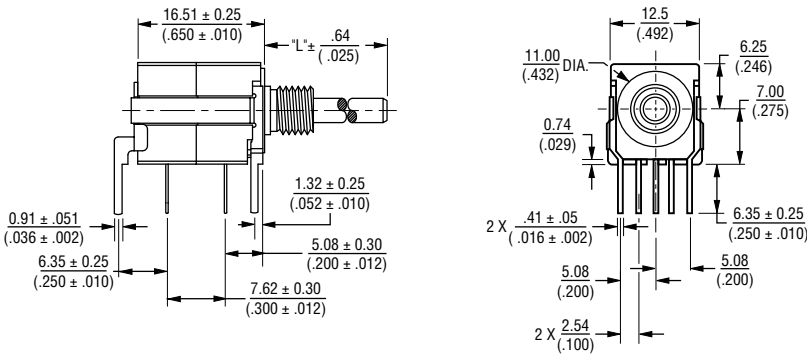

ANTI-ROTATION LUG (Style "A", 90° CW Shown)

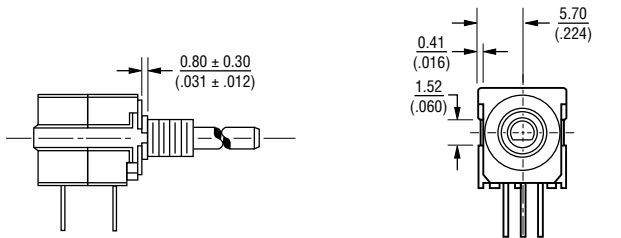

SHAFT FLAT ORIENTATION

SHAFT FLAT SHOWN AT 50% OF MECHANICAL TRAVEL.

FOR TOLERANCES SHOWN: .XX ± $\frac{.25}{.010}$
 .XXX ± $\frac{.13}{.005}$
 SHAFT DIMENSIONS ± $\frac{.80}{(1/32)}$

DIMENSIONS: $\frac{MM}{(INCHES)}$

Recommended PCB Layout

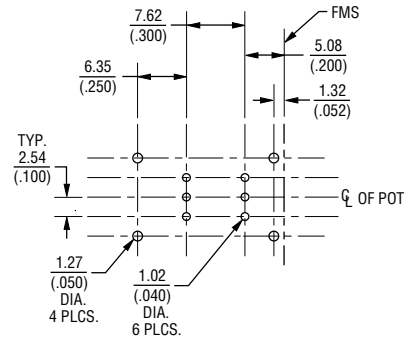

(Double Module Front and Rear Bracket Shown)

Suggested Panel Layouts

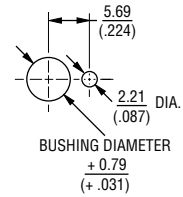

Electrical Schematic

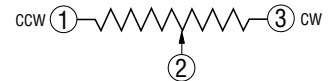

Switch Configuration



SPDT

Terminal Layout

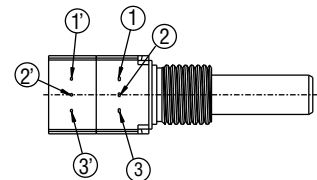

Specifications are subject to change without notice.

Users should verify actual device performance in their specific applications.

The products described herein and this document are subject to specific legal disclaimers as set forth on the last page of this document, and at www.bourns.com/docs/legal/disclaimer.pdf.

56 – Sealed 1/2" (12.5 mm) Panel Control w/Rotary Switch



Shaft/Bushing Styles

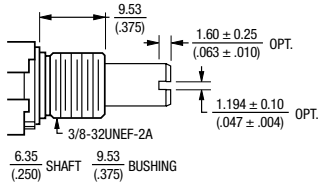

A Style Bushing	
STD. LENGTH 'L'	
.750	(19.05)
.875	(22.23)

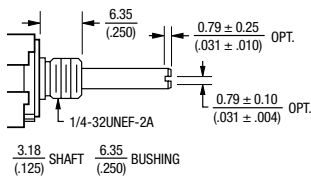

C Style Bushing	
STD. LENGTH 'L'	
.750	(19.05)
.875	(22.23)

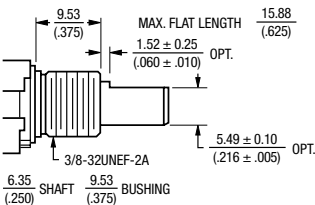

A Style Bushing - Flatted Shaft	
STD. LENGTH 'L'	
.750	(19.05)
.875	(22.23)

DIMENSIONS: $\frac{\text{MM}}{\text{(INCHES)}}$

How To Order

56 A A D - C 28 - B 15 / R81 L

ANTI-ROTATION LUG / BRACKET OPTION	
Code	Description
A	AR Lug 90 °CW
D	No AR Lug or Bracket
L	Front Bracket
N	Front and Rear Bracket

NO. OF SECTIONS	
Code	Description
A	Single plus Switch

BUSHING DESIGNATOR	
Code	Description
A	3/8" D x 3/8" L Threaded
C	1/4" D x 1/4" L Threaded

MODEL	
Code	Description
56	PC Terminals w/Rotary Switch

RoHS IDENTIFIER	
Code	Description
L	Compliant

SWITCH OPTION	
Code	Description
R80	SPDT CW
R81	SPDT CCW

RESISTANCE CODES	
Code	Value in Ohms
10	1K
13	5K
15	10K
18	50K
20	100K
22	250K
23	500K

ELEMENT TAPER TYPE/TOLERANCE	
Code	Description
B	Linear CP ±20 %
E	Linear CP ±10 %
D	CW Audio CP ±20 %
S	CW Audio CP ±10 %

SHAFT LENGTH DESIGNATOR	
Code	Description
24	3/4" FMS Long
28	7/8" FMS Long

SHAFT STYLE		AVAILABLE ONLY WITH BUSHING
Code	Description	Code
B	1/4" D Slotted End	A
C	1/4" D Flatted End	A
E	1/8" D Slotted End	C

Boldface features are Bourns standard options. All others are available with higher minimum order quantities.



Asia-Pacific: Tel: +886-2 2562-4117 • Email: asiacus@bourns.com

EMEA: Tel: +36 88 885 877 • Email: eurocus@bourns.com

The Americas: Tel: +1-951 781-5500 • Email: americus@bourns.com

www.bourns.com

REV. 10/20

Specifications are subject to change without notice.

Users should verify actual device performance in their specific applications.

The products described herein and this document are subject to specific legal disclaimers as set forth on the last page of this document, and at www.bourns.com/docs/legal/disclaimer.pdf.

Legal Disclaimer Notice

BOURNS®

This legal disclaimer applies to purchasers and users of Bourns® products manufactured by or on behalf of Bourns, Inc. and its affiliates (collectively, “Bourns”).

Unless otherwise expressly indicated in writing, Bourns® products and data sheets relating thereto are subject to change without notice. Users should check for and obtain the latest relevant information and verify that such information is current and complete before placing orders for Bourns® products.

The characteristics and parameters of a Bourns® product set forth in its data sheet are based on laboratory conditions, and statements regarding the suitability of products for certain types of applications are based on Bourns’ knowledge of typical requirements in generic applications. The characteristics and parameters of a Bourns® product in a user application may vary from the data sheet characteristics and parameters due to (i) the combination of the Bourns® product with other components in the user’s application, or (ii) the environment of the user application itself. The characteristics and parameters of a Bourns® product also can and do vary in different applications and actual performance may vary over time. Users should always verify the actual performance of the Bourns® product in their specific devices and applications, and make their own independent judgments regarding the amount of additional test margin to design into their device or application to compensate for differences between laboratory and real world conditions.

Unless Bourns has explicitly designated an individual Bourns® product as meeting the requirements of a particular industry standard (e.g., ISO/TS 16949) or a particular qualification (e.g., UL listed or recognized), Bourns is not responsible for any failure of an individual Bourns® product to meet the requirements of such industry standard or particular qualification. Users of Bourns® products are responsible for ensuring compliance with safety-related requirements and standards applicable to their devices or applications.

Bourns® products are not recommended, authorized or intended for use in nuclear, lifesaving, life-critical or life-sustaining applications, nor in any other applications where failure or malfunction may result in personal injury, death, or severe property or environmental damage. Unless expressly and specifically approved in writing by two authorized Bourns representatives on a case-by-case basis, use of any Bourns® products in such unauthorized applications might not be safe and thus is at the user’s sole risk. Life-critical applications include devices identified by the U.S. Food and Drug Administration as Class III devices and generally equivalent classifications outside of the United States.

Bourns expressly identifies those Bourns® standard products that are suitable for use in automotive applications on such products’ data sheets in the section entitled “Applications.” Unless expressly and specifically approved in writing by two authorized Bourns representatives on a case-by-case basis, use of any other Bourns® standard products in an automotive application might not be safe and thus is not recommended, authorized or intended and is at the user’s sole risk. If Bourns expressly identifies a sub-category of automotive application in the data sheet for its standard products (such as infotainment or lighting), such identification means that Bourns has reviewed its standard product and has determined that if such Bourns® standard product is considered for potential use in automotive applications, it should only be used in such sub-category of automotive applications. Any reference to Bourns® standard product in the data sheet as compliant with the AEC-Q standard or “automotive grade” does not by itself mean that Bourns has approved such product for use in an automotive application.

Bourns® standard products are not tested to comply with United States Federal Aviation Administration standards generally or any other generally equivalent governmental organization standard applicable to products designed or manufactured for use in aircraft or space applications. Bourns expressly identifies Bourns® standard products that are suitable for use in aircraft or space applications on such products’ data sheets in the section entitled “Applications.” Unless expressly and specifically approved in writing by two authorized Bourns representatives on a case-by-case basis, use of any other Bourns® standard product in an aircraft or space application might not be safe and thus is not recommended, authorized or intended and is at the user’s sole risk.

The use and level of testing applicable to Bourns® custom products shall be negotiated on a case-by-case basis by Bourns and the user for which such Bourns® custom products are specially designed. Absent a written agreement between Bourns and the user regarding the use and level of such testing, the above provisions applicable to Bourns® standard products shall also apply to such Bourns® custom products.

Users shall not sell, transfer, export or re-export any Bourns® products or technology for use in activities which involve the design, development, production, use or stockpiling of nuclear, chemical or biological weapons or missiles, nor shall they use Bourns® products or technology in any facility which engages in activities relating to such devices. The foregoing restrictions apply to all uses and applications that violate national or international prohibitions, including embargos or international regulations. Further, Bourns® products and Bourns technology and technical data may not under any circumstance be exported or re-exported to countries subject to international sanctions or embargoes. Bourns® products may not, without prior authorization from Bourns and/or the U.S. Government, be resold, transferred, or re-exported to any party not eligible to receive U.S. commodities, software, and technical data.

To the maximum extent permitted by applicable law, Bourns disclaims (i) any and all liability for special, punitive, consequential, incidental or indirect damages or lost revenues or lost profits, and (ii) any and all implied warranties, including implied warranties of fitness for particular purpose, non-infringement and merchantability.

For your convenience, copies of this Legal Disclaimer Notice with German, Spanish, Japanese, Traditional Chinese and Simplified Chinese bilingual versions are available at:

Web Page: <http://www.bourns.com/legal/disclaimers-terms-and-policies>

PDF: <http://www.bourns.com/docs/Legal/disclaimer.pdf>

X-ON Electronics

Largest Supplier of Electrical and Electronic Components

Click to view similar products for [Potentiometers](#) category:

Click to view products by [Bourns](#) manufacturer:

Other Similar products are found below :

[58C2-2](#) [590SX1N32F103SS](#) [591SXJ48S252SC](#) [591SXP56S252SC](#) [591SXP56S503SC](#) [D31409](#) [70B1G048K502X-A](#) [70B1M032S502W](#)
[70B1N056S202W](#) [70B8N056F502W](#) [70J8N048S104U](#) [70L1N040P103W](#) [70L1N048P103X](#) [70L1N048S103W](#) [GA2L040S102UC](#)
[GA2L040S103UC](#) [GS1G044P103UA](#) [GS1N048P103UA](#) [GS1T032S103UA](#) [A43-1500](#) [A43-20K](#) [A47-200K](#) [A4720K](#) [RA20LASD251A](#)
[132-2-0-202](#) [132-0-0-202](#) [RK14K1220-F25-C0-A103](#) [RK14K1220F25C0C104](#) [RK14K1220-F25-C1-B103](#) [14910FAGJSX10102KA](#)
[14910FBGLFY00103KA](#) [14910AABHSX10103KA](#) [14910FAGJSX10104KA](#) [152-01031](#) [C0342008 5K](#) [P270-109A](#) [J97589](#) [23M728](#)
[248BBHS0XB25104MA](#) [RV170F-10-15R1-B500K-0021](#) [RV8NAYSB104A](#) [917523A](#) [A43-40](#) [A43-750](#) [A43S-5](#) [A47-15K](#) [A4750K](#)
[SPPG048S103U](#) [SPPG056P103U](#) [SWE-10](#)