

Features

- Metal foil
- High power density
- High reliability and stability
- RoHS compliant* and halogen free**
- AEC-Q200 Compliant

Applications

- Current sensing
- Power supplies
- Stepper motor drives
- Input amplifiers

CFN-A Series Metal Foil, Current Sensing Chip Resistor

Electrical Characteristics

Characteristic	CFN0402A	CFN0603A	CFN0805A	CFN1206A
Power Rating @ 70 °C	0.2 W	0.5 W	0.75 W	1 W
Resistance Value	10 mΩ, 20 mΩ	5 mΩ, 10 mΩ, 20 mΩ	5 mΩ, 10 mΩ, 20 mΩ, 30 mΩ	5 mΩ, 10 mΩ, 20 mΩ, 40 mΩ
Operating Temperature Range	-55 °C ~ +125 °C	-55 °C ~ +155 °C		
Temperature Coefficient of Resistance	±100 ppm/°C	±50 ppm/°C & ±100 ppm/°C		
Tolerance		±1 %, ±5 %		

Additional Information

Click these links for more information:



Derating Curve

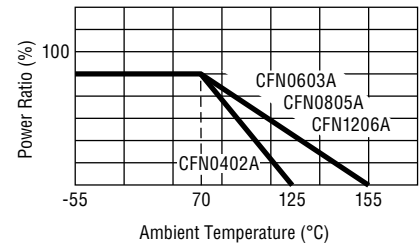

Environmental Characteristics

Storage Conditions
 Temperature +5 °C ~ +35 °C
 Humidity 40 % ~ 75 %
 Shelf Life 2 years from manufacturing date
 Solder Recommendations Reflow profile
 (Solder: Sn96.5 / Ag3 / Cu0.5)
 Moisture Sensitivity Level 1

Product Dimensions

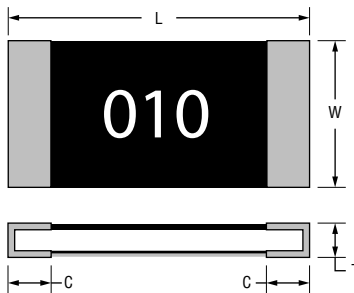

	L	W	D	t
CFN0402A	$\frac{1.10 \pm 0.10}{(.043 \pm .004)}$	$\frac{0.55 \pm 0.10}{(.021 \pm .004)}$	$\frac{0.25 \pm 0.10}{(.009 \pm .004)}$	$\frac{0.45 \pm 0.10}{(.017 \pm .004)}$
CFN0603A	$\frac{1.60 \pm 0.20}{(.063 \pm .008)}$	$\frac{0.80 \pm 0.20}{(.031 \pm .008)}$	$\frac{0.40 \pm 0.20}{(.016 \pm .008)}$	$\frac{0.60 \pm 0.20}{(.024 \pm .008)}$
CFN0805A	$\frac{2.00 \pm 0.20}{(.079 \pm .008)}$	$\frac{1.25 \pm 0.20}{(.049 \pm .008)}$	$\frac{0.40 \pm 0.20}{(.016 \pm .008)}$	$\frac{0.70 \pm 0.20}{(.028 \pm .008)}$
CFN1206A	$\frac{3.20 \pm 0.20}{(.126 \pm .008)}$	$\frac{1.60 \pm 0.20}{(.063 \pm .008)}$	$\frac{0.50 \pm 0.20}{(.020 \pm .008)}$	$\frac{0.70 \pm 0.20}{(.028 \pm .008)}$

DIMENSIONS: $\frac{\text{MM}}{\text{(INCHES)}}$



WARNING Cancer and Reproductive Harm

www.P65Warnings.ca.gov

* RoHS Directive 2015/863, Mar 31, 2015 and Annex.

** Bourns considers a product to be "halogen free" if (a) the Bromine (Br) content is 900 ppm or less; (b) the Chlorine (Cl) content is 900 ppm or less; and (c) the total Bromine (Br) and Chlorine (Cl) content is 1500 ppm or less.

Specifications are subject to change without notice.

Users should verify actual device performance in their specific applications.

The products described herein and this document are subject to specific legal disclaimers as set forth on the last page of this document, and at www.bourns.com/docs/legal/disclaimer.pdf.

CFN-A Series Metal Foil, Current Sensing Chip Resistor



Construction

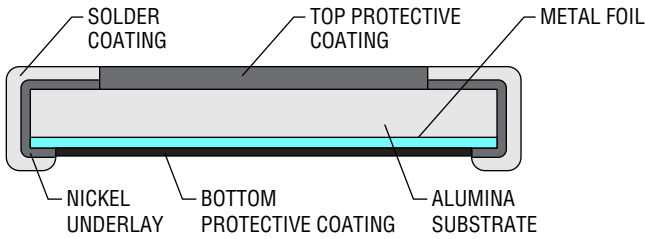

Recommended Solder Pad Dimensions

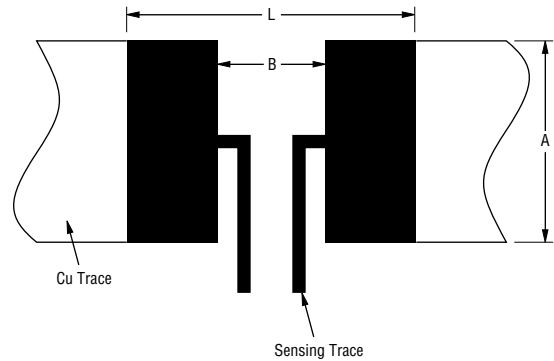

Marking



CFN0805A
CFN1206A
 005 = 5 mΩ
 010 = 10 mΩ
 020 = 20 mΩ
 6.5 = 6.5 mΩ

CFN0402A
CFN0603A
 No Marking

Model		A	L	B
CFN0402A	$10 \leq R \leq 20$	$\frac{0.70}{(.027)}$	$\frac{1.20}{(.047)}$	$\frac{0.45}{(.018)}$
	$10 \leq R \leq 20$	$\frac{1.00}{(.039)}$	$\frac{2.80}{(.110)}$	$\frac{0.60}{(.024)}$
CFN0805A	$10 \leq R \leq 30$	$\frac{1.40}{(.055)}$	$\frac{3.20}{(.126)}$	$\frac{1.20}{(.047)}$
CFN1206A	$20 \leq R \leq 30$	$\frac{1.80}{(.071)}$	$\frac{4.70}{(.185)}$	$\frac{1.60}{(.063)}$
	$R = 40$			$\frac{2.20}{(.087)}$

DIMENSIONS: $\frac{\text{MM}}{\text{(INCHES)}}$

Specifications are subject to change without notice.

Users should verify actual device performance in their specific applications.

The products described herein and this document are subject to specific legal disclaimers as set forth on the last page of this document, and at www.bourns.com/docs/legal/disclaimer.pdf.

CFN-A Series Metal Foil, Current Sensing Chip Resistor



Solder Reflow Recommendations

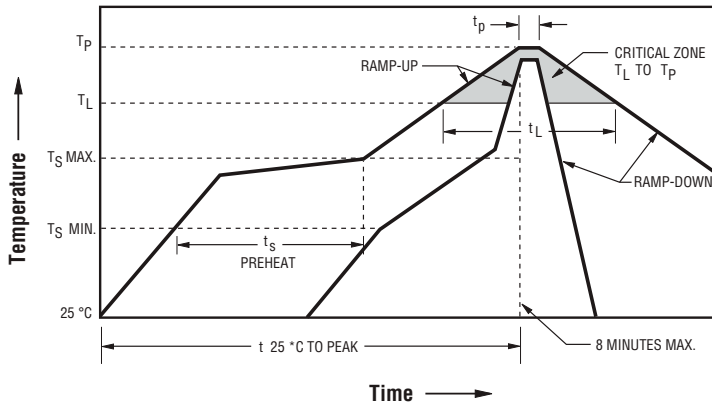

Solder Profile	Lead Free Assembly
Average ramp-up rate (T _{smax} to T _p)	3 °C / second max.
Preheat: - Temperature Min. (T _{smin}) - Temperature Max. (T _{smax}) - Time (T _{smin} to T _{smax}) (t _s)	150 °C 200 °C 60~150 seconds
Time maintained above: - Temperature (T _L) - Time (T _L)	217 °C 60~120 seconds
Peak Temperature (T _p)	260 °C
Time within +0/-5 °C of actual Peak Temperature (T _p) ²	10 seconds
Ramp-down rate	6 °C / second max.
Time 25 °C to Peak Temperature	8 minutes max.

How to Order

CFN 0805 A F X - R005 E LF

Model _____
 CFN = Metal Foil Current Sense Resistor

Size _____
 0402 = 0402 Size
 0603 = 0603 Size
 0805 = 0805 Size
 1206 = 1206 Size

Feature _____
 A = AEC-Q200 Compliant

Resistance Tolerance _____
 F = ±1 %
 J = ±5 %

TCR _____
 X = ±100 PPM/°C
 Z = ±50 PPM/°C

Resistance Code – (See Popular Resistance Table) _____
 "R" (decimal point) followed by three significant digits (example: R005 = 0.005 ohms)

Packaging _____
 E = Tape and Reel
 4,000 pcs. / 7-inch reel, paper tape (CFN0805A, CFN1206A)
 5,000 pcs. / 7-inch reel, paper tape (CFN0603A)
 10,000 pcs. / 7-inch reel, paper tape (CFN0402A)

Termination _____
 LF = Tin-plated (RoHS Compliant)

Specifications are subject to change without notice.
 Users should verify actual device performance in their specific applications.
 The products described herein and this document are subject to specific legal disclaimers as set forth on the last page of this document, and at www.bourns.com/docs/legal/disclaimer.pdf.

CFN-A Series Metal Foil, Current Sensing Chip Resistor



Packaging Dimensions (Conforms to EIA RS-481A)

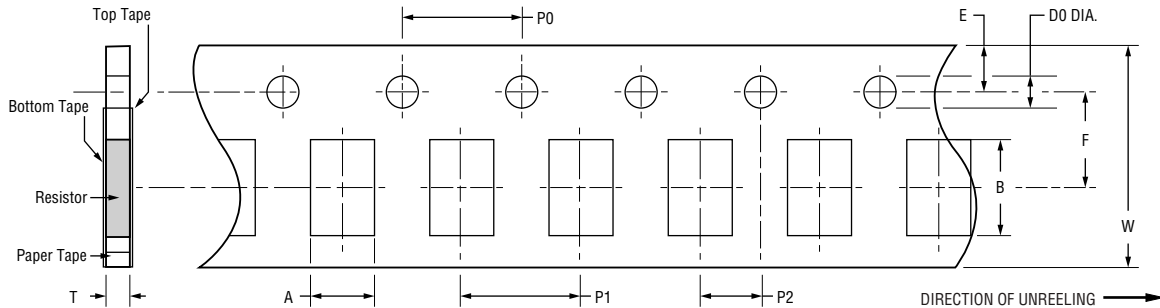

	A	B	W	F	E	P1	P2	P0	D0	T
CFN0402A	$\frac{0.75}{(.030)}$	$\frac{1.30}{(.051)}$	$\frac{8.00}{(.315)}$	$\frac{3.50}{(.138)}$	$\frac{1.75}{(.069)}$	$\frac{2.00}{(.079)}$	$\frac{2.00}{(.079)}$	$\frac{4.00}{(.157)}$	$\frac{1.50}{(.059)}$	$\frac{0.65}{(.026)}$
CFN0603A	$\frac{1.10}{(.043)}$	$\frac{1.90}{(.075)}$				$\frac{0.85}{(.033)}$				
CFN0805A	$\frac{1.60}{(.063)}$	$\frac{2.40}{(.094)}$				$\frac{1.05}{(.041)}$				
CFN1206A	$\frac{2.00}{(.079)}$	$\frac{3.60}{(.142)}$				$\frac{1.05}{(.041)}$				

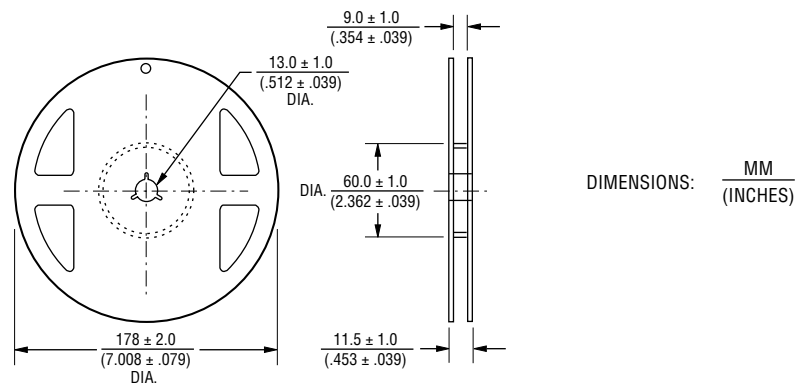

Asia-Pacific: Tel: +886-2 2562-4117 • Email: asiacus@bourns.com

EMEA: Tel: +36 88 885 877 • Email: eurocus@bourns.com

The Americas: Tel: +1-951 781-5500 • Email: americus@bourns.com

www.bourns.com

Specifications are subject to change without notice.

Users should verify actual device performance in their specific applications.

The products described herein and this document are subject to specific legal disclaimers as set forth on the last page of this document, and at www.bourns.com/docs/legal/disclaimer.pdf.

Reliability Tests

Test Items	Reference Standard	Condition of Test	Test Limits
Temperature Coefficient of Resistance	IEC 60115-1 4.8	+25 ~ 125 °C	Reference item 4
Short Time Overload	IEC 60115-1 4.13	5X rated power for 5 s	< ±1 %
High Temperature Exposure (Storage)	AEC-Q200-REV D-Test 3 MIL-STD-202 Method 108	1000 hrs @ T = 125 °C. Unpowered. Measurement at 24 ±2 hours after test conclusion.	< ±1 %
Temperature Cycling	AEC-Q200-REV D-Test 4 JESD22 Method JA-104	1000 cycles (-55 °C to +125 °C). Measurement at 24 ±4 hours after test conclusion. 30 min. max. dwell time at each temperature extreme. 1 min. max. transition time.	< ±1 %
Moisture Resistance	AEC-Q200-REV D-Test 6 MIL-STD-202 Method 106	T = 24 hours/cycle, 10 cycles. Notes: Steps 7a & 7b not required. Unpowered.	< ±1 %
Biased Humidity	AEC-Q200-REV D-Test 7 MIL-STD-202 Method 103	1000 hours 85 °C / 85 % RH. Note: Specified conditions: 10 % of operating power (not exceeding max. working voltage). Measurement at 24 ±2 hours after test conclusion.	< ±1 %
Operational Life	AEC-Q200-REV D-Test 8 MIL-STD-202 Method 108	1000 hours T _A = 125 °C at 35 % rated power. Measurement at 24 ±4 hours after test conclusion.	< ±2 %
External Visual	AEC-Q200-REV D-Test 9 MIL-STD-883 Method 2009	Electrical test not required. Inspect device construction, marking and workmanship.	
Physical Dimensions	AEC-Q200-REV D-Test 10 JESD22 Method JB-100	Verify physical dimensions to the applicable device detail specification. Note: User(s) and Suppliers spec. Electrical test not required.	
Resistance to Solvents	AEC-Q200-REV D-Test 12 MIL-STD-202 Method 215	a: Isopropyl Alcohol : Mineral Spirits = 1 : 3 b: Terpene Defluxer (Bioact EC-7R) c: Deionized Water : Propylene Glycol Monomethyl Ether : monoethanolamine 42 : 1 : 1	Marking and protective layer cannot be detached
Mechanical Shock	AEC-Q200-REV D-Test 13 MIL-STD-202 Method 213	Wave Form: Tolerance for half sine shock pulse. Peak value is 100 g's. Normal duration (D) is 6 ms	< ±1.0 %
Vibration	AEC-Q200-REV D-Test 14 MIL-STD-202 Method 204	5 g's for 20 min., 12 cycles each of 3 orientations. Note: Test from 10-2000 Hz.	< ±1.0 %
Resistance to Soldering Heat	AEC-Q200-REV D-Test 15 MIL-STD-202 Method 210	Condition B: Immerse the specimens in an eutectic solder at 260 ±5 °C for 10 ±1 s.	< ±0.5 %
Thermal Shock	AEC-Q200-REV D-Test 16 MIL-STD-202 Method 107	-55 °C / +155 °C. Note: Number of cycles required: 300, Maximum transfer time: 20 s, Dwell time: 15 minutes, Air - Air	< ±1.0 %
ESD	AEC-Q200-REV D-Test 17 AEC-Q200-002 or ISO/DIS 10605	Verify the voltage setting at 500 V	< ±1.0 %
Solderability	AEC-Q200-REV D-Test 18 J-STD-202	Method B, aging 4 hours @ 155 °C dry heat. Lead-free solder bath @ 235 ±3 °C Dipping time: 3 ±0.5 seconds.	> 95 % area covered with tin
Flammability	AEC-Q200-REV D-Test 20 UL 94	V-0 or V-1 are acceptable. Electrical test not required.	V-0 or V-1
Board Flex (Bending)	AEC-Q200-REV D-Test 21 AEC-Q200-005	The duration of the applied forces shall be 60 +5 seconds 3 mm deflection (RLS06 ~ RLS 12) 2 mm deflection (RLS 25)	< ±1.0 %
Terminal Strength (SMD)	AEC-Q200-REV D-Test 22 AEC-Q200-006	Force of 1.8 kg for 60 seconds Remarks: 0201-NA	< ±1.0 %

05/21

Specifications are subject to change without notice.

Users should verify actual device performance in their specific applications.

The products described herein and this document are subject to specific legal disclaimers as set forth on the last page of this document, and at www.bourns.com/docs/legal/disclaimer.pdf.

This legal disclaimer applies to purchasers and users of Bourns® products manufactured by or on behalf of Bourns, Inc. and its affiliates (collectively, "Bourns").

Unless otherwise expressly indicated in writing, Bourns® products and data sheets relating thereto are subject to change without notice. Users should check for and obtain the latest relevant information and verify that such information is current and complete before placing orders for Bourns® products.

The characteristics and parameters of a Bourns® product set forth in its data sheet are based on laboratory conditions, and statements regarding the suitability of products for certain types of applications are based on Bourns' knowledge of typical requirements in generic applications. The characteristics and parameters of a Bourns® product in a user application may vary from the data sheet characteristics and parameters due to (i) the combination of the Bourns® product with other components in the user's application, or (ii) the environment of the user application itself. The characteristics and parameters of a Bourns® product also can and do vary in different applications and actual performance may vary over time. Users should always verify the actual performance of the Bourns® product in their specific devices and applications, and make their own independent judgments regarding the amount of additional test margin to design into their device or application to compensate for differences between laboratory and real world conditions.

Unless Bourns has explicitly designated an individual Bourns® product as meeting the requirements of a particular industry standard (e.g., ISO/TS 16949) or a particular qualification (e.g., UL listed or recognized), Bourns is not responsible for any failure of an individual Bourns® product to meet the requirements of such industry standard or particular qualification. Users of Bourns® products are responsible for ensuring compliance with safety-related requirements and standards applicable to their devices or applications.

Bourns® products are not recommended, authorized or intended for use in nuclear, lifesaving, life-critical or life-sustaining applications, nor in any other applications where failure or malfunction may result in personal injury, death, or severe property or environmental damage. Unless expressly and specifically approved in writing by two authorized Bourns representatives on a case-by-case basis, use of any Bourns® products in such unauthorized applications might not be safe and thus is at the user's sole risk. Life-critical applications include devices identified by the U.S. Food and Drug Administration as Class III devices and generally equivalent classifications outside of the United States.

Bourns expressly identifies those Bourns® standard products that are suitable for use in automotive applications on such products' data sheets in the section entitled "Applications." Unless expressly and specifically approved in writing by two authorized Bourns representatives on a case-by-case basis, use of any other Bourns® standard products in an automotive application might not be safe and thus is not recommended, authorized or intended and is at the user's sole risk. If Bourns expressly identifies a sub-category of automotive application in the data sheet for its standard products (such as infotainment or lighting), such identification means that Bourns has reviewed its standard product and has determined that if such Bourns® standard product is considered for potential use in automotive applications, it should only be used in such sub-category of automotive applications. Any reference to Bourns® standard product in the data sheet as compliant with the AEC-Q standard or "automotive grade" does not by itself mean that Bourns has approved such product for use in an automotive application.

Bourns® standard products are not tested to comply with United States Federal Aviation Administration standards generally or any other generally equivalent governmental organization standard applicable to products designed or manufactured for use in aircraft or space applications. Bourns expressly identifies Bourns® standard products that are suitable for use in aircraft or space applications on such products' data sheets in the section entitled "Applications." Unless expressly and specifically approved in writing by two authorized Bourns representatives on a case-by-case basis, use of any other Bourns® standard product in an aircraft or space application might not be safe and thus is not recommended, authorized or intended and is at the user's sole risk.

The use and level of testing applicable to Bourns® custom products shall be negotiated on a case-by-case basis by Bourns and the user for which such Bourns® custom products are specially designed. Absent a written agreement between Bourns and the user regarding the use and level of such testing, the above provisions applicable to Bourns® standard products shall also apply to such Bourns® custom products.

Users shall not sell, transfer, export or re-export any Bourns® products or technology for use in activities which involve the design, development, production, use or stockpiling of nuclear, chemical or biological weapons or missiles, nor shall they use Bourns® products or technology in any facility which engages in activities relating to such devices. The foregoing restrictions apply to all uses and applications that violate national or international prohibitions, including embargos or international regulations. Further, Bourns® products and Bourns technology and technical data may not under any circumstance be exported or re-exported to countries subject to international sanctions or embargoes. Bourns® products may not, without prior authorization from Bourns and/or the U.S. Government, be resold, transferred, or re-exported to any party not eligible to receive U.S. commodities, software, and technical data.

To the maximum extent permitted by applicable law, Bourns disclaims (i) any and all liability for special, punitive, consequential, incidental or indirect damages or lost revenues or lost profits, and (ii) any and all implied warranties, including implied warranties of fitness for particular purpose, non-infringement and merchantability.

For your convenience, copies of this Legal Disclaimer Notice with German, Spanish, Japanese, Traditional Chinese and Simplified Chinese bilingual versions are available at:

Web Page: <http://www.bourns.com/legal/disclaimers-terms-and-policies>

PDF: <http://www.bourns.com/docs/Legal/disclaimer.pdf>

X-ON Electronics

Largest Supplier of Electrical and Electronic Components

Click to view similar products for [Current Sense Resistors - SMD category](#):

Click to view products by [Bourns manufacturer](#):

Other Similar products are found below :

[CRL0603-FW-R700ELF](#) [PFS35-200RF1](#) [NPS 2-T126 5.000 OHM 1%](#) [PFS35-0R01J1](#) [PFS35-0R05J1](#) [PFS35-5RF1](#) [CD2015FC-0.10-1%](#)
[PR2512FKF7W0R004L](#) [RC1005F124CS](#) [RL73K3AR56JTDF](#) [RL7520WT-R001-F](#) [RL7520WT-R009-G](#) [RL7520WT-R020-F](#) [LRC-](#)
[LR2512LF-01-R820J](#) [WR06X104JGLJ](#) [TL2BR01F](#) [65709-330](#) [SP1R12J](#) [RL7520WT-R039-G](#) [RL7520WT-R002-F](#) [LRF2010-R003JW](#)
[KRL1632E-C-R200-F-T5](#) [KRL1632E-C-R200-F-T1](#) [RLP73M1ER051FTDF](#) [RLP73M2AR075FTDF](#) [SR731ERTTP5R10F](#) [SR731ERTTP100J](#)
[SR731ERTTP6R80F](#) [SR731ERTTP4R70F](#) [SR731ERTTP2R20F](#) [SR731ERTTP3R90F](#) [SR731ERTTP1R00F](#) [SR731ERTTP10R0F](#)
[SR731ERTTP2R00F](#) [SR731ERTTP8R20F](#) [SR731ERTTP3R9J](#) [SR731ERTTP8R2J](#) [SR731ERTTP2R0J](#) [SR731ERTTP4R7J](#)
[SR731ERTTP9R1J](#) [SR731ERTTP1R0J](#) [SR731ERTTP2R2J](#) [SR731ERTTP5R1J](#) [SR731ERTTP6R8J](#) [SR731ERTTP9R10F](#) [FCSL64R007JER](#)
[LRF1206-R018FW](#) [TLR2B10DR022FTDG](#) [TLR2H10DR01FTDG](#) [73L4R10G](#)