

## Features

- Fuses at 120 V or 240 V
- E24 resistance values
- RoHS compliant\*
- UL 1412 recognized
- Coating material meets UL 94V-0 requirements

## Applications

- White goods
- Inverters
- Lighting
- Metering

# FWxxA Series Fusible Power Resistors

### General Introduction

The FWxxA Series of axial leaded wirewound resistors is designed to fuse under abnormal conditions such as sudden surges in voltage or circuit malfunctions. The resistor will fuse upon application of 120 or 240 voltages.

### Electrical Characteristics

Characteristic	FW Series
Power	1, 2, 3, 5, 7** W
Resistance Range	4.7 ohms to 100 ohms (E24 values)
UL 1412 Recognized Resistance Range	4.7 ohms to 47 ohms
Tolerance	5 %
Temperature Coefficient	±200 PPM/°C
Operating Temperature Range	-55 °C to +155 °C
Maximum Voltage	√P*R
Fusing Point	See Fusing Performance Chart
Fusing Time	See Fusing Performance Chart

The resistor will fuse safely if 120 or 240 V is applied. The time to fuse depends on the resistance value.

\*\* 7 W = 240 Vac only.

### Product Dimensions

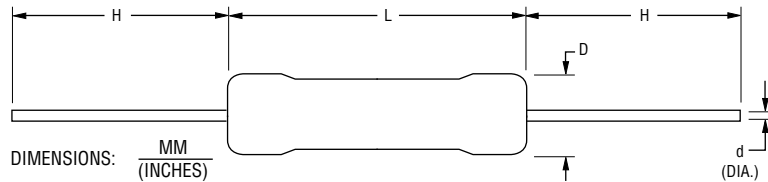

Model	Dimensions			
	D (Max.)	L (Max.)	H	d
FW10A (1 W)	$\frac{5.0}{(.197)}$	$\frac{12}{(.472)}$	$\frac{28 \pm 3.0}{(1.102 \pm .118)}$	$\frac{0.55 \pm 0.05}{(.022 \pm .002)}$
FW20A (2 W)	$\frac{6.0}{(.236)}$	$\frac{12}{(.472)}$	$\frac{28 \pm 3.0}{(1.102 \pm .118)}$	$\frac{0.65 \pm 0.05}{(.026 \pm .002)}$
FW30A (3 W)	$\frac{6.5}{(.256)}$	$\frac{16}{(.630)}$	$\frac{28 \pm 3.0}{(1.102 \pm .118)}$	$\frac{0.75 \pm 0.05}{(.030 \pm .002)}$
FW50A (5 W)	$\frac{7.5}{(.295)}$	$\frac{18}{(.709)}$	$\frac{28 \pm 3.0}{(1.102 \pm .118)}$	$\frac{0.75 \pm 0.05}{(.030 \pm .002)}$
FW70A (7 W)	$\frac{9.5}{(.374)}$	$\frac{26}{(1.024)}$	$\frac{38 \pm 3.0}{(1.496 \pm .118)}$	$\frac{0.75 \pm 0.05}{(.030 \pm .002)}$

### Agency Recognition

Description	
UL 1412	File Number: E349323

### Materials

Resistor ..... Wire wound around a ceramic core  
 Lead Wire ..... Tinned copper  
 Housing ..... Insulated resin  
 Coating Material ..... Meets UL 94V-0 requirements

### How to Order

**FW 10 A 7R50 J A**

Model \_\_\_\_\_  
 FW = Fusible Wirewound

Rated Power \_\_\_\_\_  
 10 = 1.0 Watts  
 20 = 2.0 Watts  
 30 = 3.0 Watts  
 50 = 5.0 Watts  
 70 = 7.0 Watts

Pin Style \_\_\_\_\_  
 A = Axial

Resistance Code \_\_\_\_\_  
 •  $R < 100$  ohms:  
 "R" represents decimal point (examples: 7R50 = 7.5 ohms)  
 •  $R \geq 100$  ohms:  
 First three digits are significant, fourth digit represents number of zeros to follow (example: 1000 = 100 ohms)

Resistance Tolerance \_\_\_\_\_  
 J = ±5 %

Packaging \_\_\_\_\_  
 A = Ammo Pack  
 • 1,000 pcs./box: FW10, FW20, FW30  
 • 500 pcs./box: FW50, FW70

### Popular Values

Resistance Value (Ohms)	Resistance Code	Resistance Value (Ohms)	Resistance Code
4.7	4R70	7.5	7R50
5.1	5R10	8.2	8R20
5.6	5R60	9.1	9R10
6.2	6R20	10.0	10R0
6.8	6R80		



### WARNING Cancer and Reproductive Harm

[www.P65Warnings.ca.gov](http://www.P65Warnings.ca.gov)

\*RoHS Directive 2015/863, Mar 31, 2015 and Annex. Specifications are subject to change without notice. Users should verify actual device performance in their specific applications. The products described herein and this document are subject to specific legal disclaimers as set forth on the last page of this document, and at [www.bourns.com/docs/legal/disclaimer.pdf](http://www.bourns.com/docs/legal/disclaimer.pdf)

# FWxxA Series Fusible Power Resistors

**BOURNS®**

## Performance Specifications

Characteristic	Limits	Test Method (JIS-C-5201 & JIS-C-5202)
Temperature Coefficient	±200 PPM/°C max.	<b>4.8</b> Natural resistance changes per temperature (°C):  $\frac{R_2 - R_1}{R_1(T_2 - T_1)} \times 10^6 \text{ (PPM/°C)}$ R1: Resistance value at room temp. (T1) R2: Resistance value at room temp. +100 °C (T2)
Short Time Overload	Resistance change rate is ±5 % max., with no evidence of mechanical damage.	<b>4.13</b> Permanent resistance change after the application of a potential of 2.5 times RCWV for 5 seconds.
Terminal Strength	No evidence of mechanical damage.	<b>4.16 Direct Load:</b> Resistance to a 2.5 kg direct load for 10 seconds in the direction of the longitudinal axis of the terminal leads.  <b>Twist Test:</b> Terminal leads shall be bent through 90 ° at a point of approximately 6 mm from the body of the resistor and shall be rotated through 360 ° (about the original axis of the bent terminal) in alternating directions for a total of three rotations.
Resistance to Soldering Heat	Resistance change rate is ±1 % max., with no evidence of mechanical damage.	<b>4.18</b> Permanent resistance change when leads are immersed to a point 2.0 to 2.5 mm from the body in 260 °C (±5 °C) solder for 10 (±1) seconds.
Solderability	95 % coverage minimum	<b>4.17</b> The area covered with a new, smooth, clean, shiny and continuous surface free from concentrated pinholes.  Test temp. of solder: 245 °C (±3 °C). Dwell time in solder: 2~3 seconds.
Load Life in Humidity	Resistance change rate is ±5 % max., with no evidence of mechanical damage.	<b>7.9</b> Resistance change after 1,000 hours (1.5 hours "ON", 0.5 hours "OFF") at RCWV in a humidity test chamber controlled at 40 °C (±2 °C) and 90-95 % relative humidity.
Safety Fuse	Resistance value shall increase at least 100 times initial value.	1 W ~ 5 W: Load 120/240 VAC voltage. 7 W: Load 240 VAC voltage. Resistor must be safely fused.
Dielectric Withstanding Voltage	No evidence of flashover mechanical damage, arcing or insulation breakdown.	<b>UL1412,</b> <b>19.1</b> A resistor (or a resistor and its mounting if provided), shall withstand, without breakdown, for a period of not less than one minute, a 60 Hz potential of 1000 V plus twice the rated voltage applied between live parts and dead metal parts, if any.

## Typical Part Marking

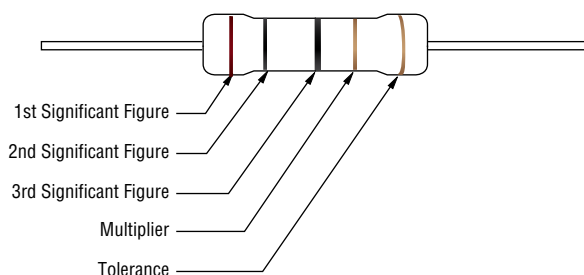

Color	1st Band	2nd Band	3rd Band	Multiplier	Tolerance
Black	0	0	0	1 Ω	
Brown	1	1	1	10 Ω	±1 %
Red	2	2	2	100 Ω	±2 %
Orange	3	3	3	1 KΩ	
Yellow	4	4	4	10 KΩ	
Green	5	5	5	100 KΩ	±0.5 %
Blue	6	6	6	1 MΩ	±0.25 %
Violet	7	7	7	10 MΩ	±0.10 %
Grey	8	8	8		±0.05 %
White	9	9	9		
Gold				0.1 Ω	±5 %
Silver				0.01 Ω	±10 %

Specifications are subject to change without notice.

Users should verify actual device performance in their specific applications.

The products described herein and this document are subject to specific disclaimers as set forth on the last page of this document, and at [www.bourns.com/legal/disclaimer.pdf](http://www.bourns.com/legal/disclaimer.pdf).

# FWxxA Series Fusible Power Resistors



## Pulse Performance

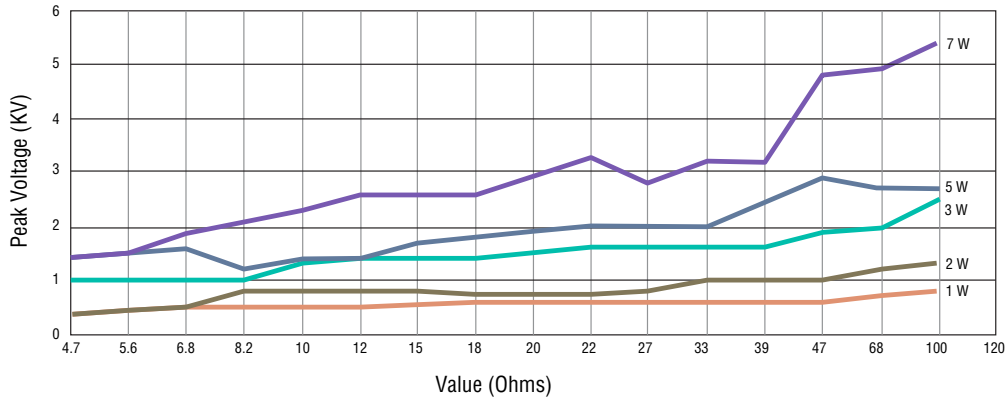

1.2/50  $\mu$ s Peak Voltage Limit (10 pulses at 10 sec. intervals,  $\Delta R < 5\%$ )

NOTE: The voltage shown in these curves is the voltage across the resistor. The generator voltage will be higher due to the generator's internal impedance.

## Fusing Performance

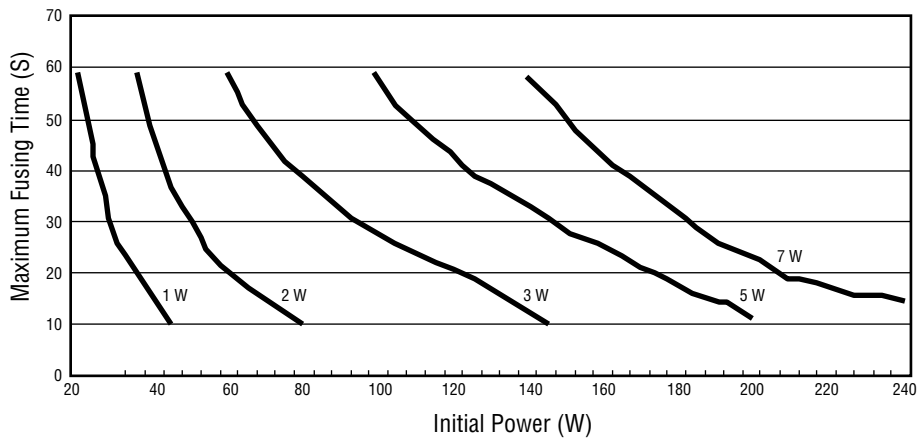

## Temperature Rise

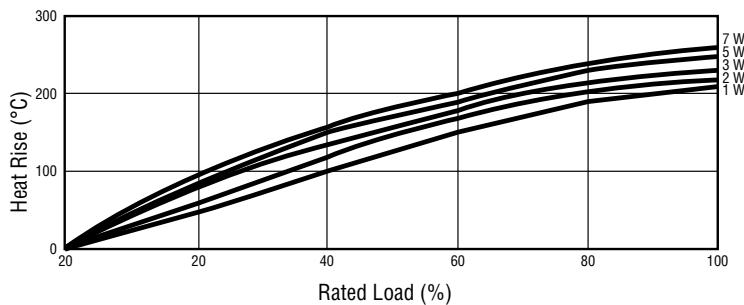

## Power Derating Curve

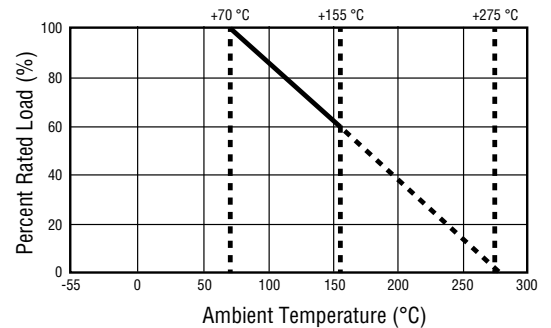

Specifications are subject to change without notice.

Users should verify actual device performance in their specific applications.

The products described herein and this document are subject to specific disclaimers as set forth on the last page of this document, and at [www.bourns.com/legal/disclaimer.pdf](http://www.bourns.com/legal/disclaimer.pdf).

# FWxxA Series Fusible Power Resistors

**BOURNS®**

## Packaging Specifications

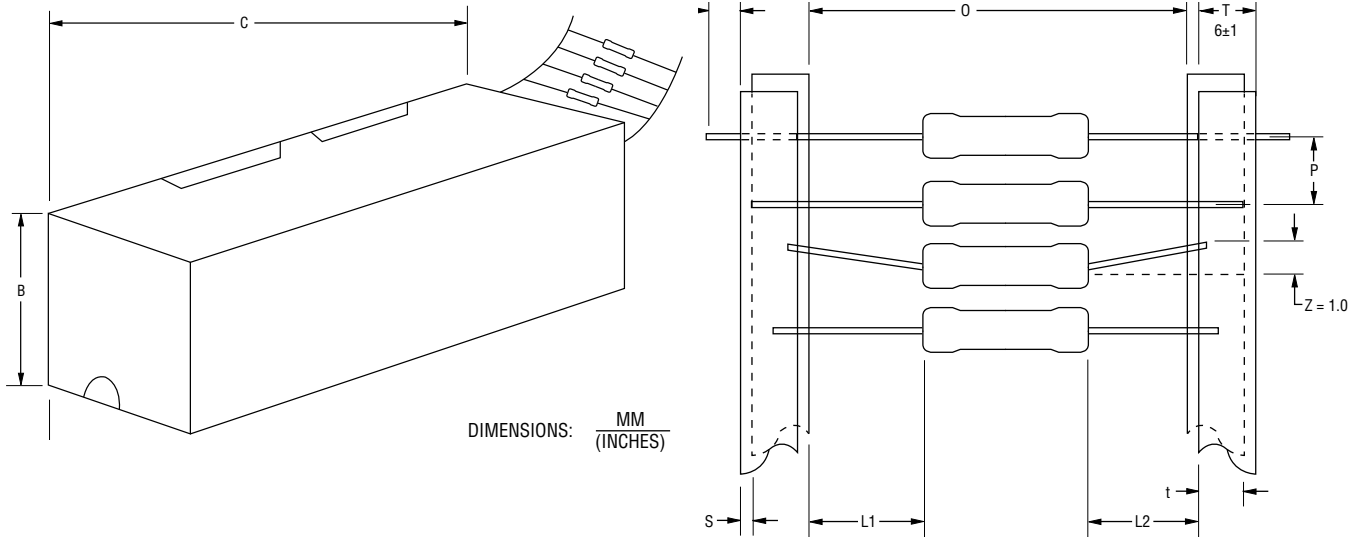

Model	O	P	A	B	C	Qty./Box
FW10A (1 W)	$\frac{52 \pm 1}{(2.047 \pm .039)}$	$\frac{5 \pm 0.3}{(.197 \pm .012)}$	$\frac{75 \pm 5}{(2.953 \pm .197)}$	$\frac{70 \pm 5}{(2.756 \pm .197)}$	$\frac{255 \pm 5}{(10.039 \pm .197)}$	1,000 pcs.
FW20A (2 W)	$\frac{58 \pm 1}{(2.283 \pm .039)}$	$\frac{10 \pm 0.5}{(.394 \pm .020)}$	$\frac{90 \pm 5}{(3.543 \pm .197)}$	$\frac{119 \pm 5}{(4.685 \pm .197)}$	$\frac{255 \pm 5}{(10.039 \pm .197)}$	1,000 pcs.
FW30A (3 W)	$\frac{65 \pm 5}{(2.559 \pm .197)}$	$\frac{10 \pm 0.5}{(.394 \pm .020)}$	$\frac{90 \pm 5}{(3.543 \pm .197)}$	$\frac{119 \pm 5}{(4.685 \pm .197)}$	$\frac{255 \pm 5}{(10.039 \pm .197)}$	1,000 pcs.
FW50A (5 W)	$\frac{65 \pm 5}{(2.559 \pm .197)}$	$\frac{10 \pm 0.5}{(.394 \pm .020)}$	$\frac{90 \pm 5}{(3.543 \pm .197)}$	$\frac{88 \pm 5}{(3.465 \pm .197)}$	$\frac{255 \pm 5}{(10.039 \pm .197)}$	500 pcs.
FW70A (7 W)	$\frac{90 \pm 5}{(3.543 \pm .197)}$	$\frac{10 \pm 0.5}{(.394 \pm .020)}$	$\frac{90 \pm 5}{(3.543 \pm .197)}$	$\frac{124 \pm 5}{(4.882 \pm .197)}$	$\frac{500 \pm 5}{(19.685 \pm .197)}$	500 pcs.

**BOURNS®**

Asia-Pacific: Tel: +886-2 2562-4117 • Email: asiacus@bourns.com

EMEA: Tel: +36 88 885 877 • Email: eurocus@bourns.com

The Americas: Tel: +1-951 781-5500 • Email: americus@bourns.com

www.bourns.com

REV. 09/19

Specifications are subject to change without notice.

Users should verify actual device performance in their specific applications.

The products described herein and this document are subject to specific disclaimers as set forth on the last page of this document, and at [www.bourns.com/legal/disclaimer.pdf](http://www.bourns.com/legal/disclaimer.pdf).

This legal disclaimer applies to purchasers and users of Bourns® products manufactured by or on behalf of Bourns, Inc. and its affiliates (collectively, “Bourns”).

Unless otherwise expressly indicated in writing, Bourns® products and data sheets relating thereto are subject to change without notice. Users should check for and obtain the latest relevant information and verify that such information is current and complete before placing orders for Bourns® products.

The characteristics and parameters of a Bourns® product set forth in its data sheet are based on laboratory conditions, and statements regarding the suitability of products for certain types of applications are based on Bourns’ knowledge of typical requirements in generic applications. The characteristics and parameters of a Bourns® product in a user application may vary from the data sheet characteristics and parameters due to (i) the combination of the Bourns® product with other components in the user’s application, or (ii) the environment of the user application itself. The characteristics and parameters of a Bourns® product also can and do vary in different applications and actual performance may vary over time. Users should always verify the actual performance of the Bourns® product in their specific devices and applications, and make their own independent judgments regarding the amount of additional test margin to design into their device or application to compensate for differences between laboratory and real world conditions.

Unless Bourns has explicitly designated an individual Bourns® product as meeting the requirements of a particular industry standard (e.g., ISO/TS 16949) or a particular qualification (e.g., UL listed or recognized), Bourns is not responsible for any failure of an individual Bourns® product to meet the requirements of such industry standard or particular qualification. Users of Bourns® products are responsible for ensuring compliance with safety-related requirements and standards applicable to their devices or applications.

Bourns® products are not recommended, authorized or intended for use in nuclear, lifesaving, life-critical or life-sustaining applications, nor in any other applications where failure or malfunction may result in personal injury, death, or severe property or environmental damage. Unless expressly and specifically approved in writing by two authorized Bourns representatives on a case-by-case basis, use of any Bourns® products in such unauthorized applications might not be safe and thus is at the user’s sole risk. Life-critical applications include devices identified by the U.S. Food and Drug Administration as Class III devices and generally equivalent classifications outside of the United States.

Bourns expressly identifies those Bourns® standard products that are suitable for use in automotive applications on such products’ data sheets in the section entitled “Applications.” Unless expressly and specifically approved in writing by two authorized Bourns representatives on a case-by-case basis, use of any other Bourns® standard products in an automotive application might not be safe and thus is not recommended, authorized or intended and is at the user’s sole risk. If Bourns expressly identifies a sub-category of automotive application in the data sheet for its standard products (such as infotainment or lighting), such identification means that Bourns has reviewed its standard product and has determined that if such Bourns® standard product is considered for potential use in automotive applications, it should only be used in such sub-category of automotive applications. Any reference to Bourns® standard product in the data sheet as compliant with the AEC-Q standard or “automotive grade” does not by itself mean that Bourns has approved such product for use in an automotive application.

Bourns® standard products are not tested to comply with United States Federal Aviation Administration standards generally or any other generally equivalent governmental organization standard applicable to products designed or manufactured for use in aircraft or space applications. Bourns expressly identifies Bourns® standard products that are suitable for use in aircraft or space applications on such products’ data sheets in the section entitled “Applications.” Unless expressly and specifically approved in writing by two authorized Bourns representatives on a case-by-case basis, use of any other Bourns® standard product in an aircraft or space application might not be safe and thus is not recommended, authorized or intended and is at the user’s sole risk.

The use and level of testing applicable to Bourns® custom products shall be negotiated on a case-by-case basis by Bourns and the user for which such Bourns® custom products are specially designed. Absent a written agreement between Bourns and the user regarding the use and level of such testing, the above provisions applicable to Bourns® standard products shall also apply to such Bourns® custom products.

Users shall not sell, transfer, export or re-export any Bourns® products or technology for use in activities which involve the design, development, production, use or stockpiling of nuclear, chemical or biological weapons or missiles, nor shall they use Bourns® products or technology in any facility which engages in activities relating to such devices. The foregoing restrictions apply to all uses and applications that violate national or international prohibitions, including embargos or international regulations. Further, Bourns® products and Bourns technology and technical data may not under any circumstance be exported or re-exported to countries subject to international sanctions or embargoes. Bourns® products may not, without prior authorization from Bourns and/or the U.S. Government, be resold, transferred, or re-exported to any party not eligible to receive U.S. commodities, software, and technical data.

To the maximum extent permitted by applicable law, Bourns disclaims (i) any and all liability for special, punitive, consequential, incidental or indirect damages or lost revenues or lost profits, and (ii) any and all implied warranties, including implied warranties of fitness for particular purpose, non-infringement and merchantability.

*For your convenience, copies of this Legal Disclaimer Notice with German, Spanish, Japanese, Traditional Chinese and Simplified Chinese bilingual versions are available at:*

*Web Page:* <http://www.bourns.com/legal/disclaimers-terms-and-policies>

*PDF:* <http://www.bourns.com/docs/Legal/disclaimer.pdf>

## X-ON Electronics

Largest Supplier of Electrical and Electronic Components

*Click to view similar products for [Wirewound Resistors - Through Hole](#) category:*

*Click to view products by [Bourns](#) manufacturer:*

Other Similar products are found below :

[G05C7R000HB1223](#) [PW10-39R-5%](#) [EP3WS47RJ](#) [CA00021R000JE14](#) [RWR81SR427DRB12](#) [RWR81SR619FRBSL](#) [RWR89S10R0FRB12](#)  
[RWR89S9310FPB12](#) [93J62RE](#) [AC04000001008JAC00](#) [FSQ5WR47J](#) [25J39K](#) [25W1D0](#) [CP0005270R0JE1491](#) [CP0005330R0JE3191](#)  
[CPCC03R5000JB31](#) [CPCC0510R00JE32](#) [CPCC051R000JB31](#) [CPCP10500R0JE32](#) [CPW052K500JE143](#) [CPW05700R0JE143](#)  
[CPW152K500JE313](#) [C1010RJL](#) [CA000210R00JE14](#) [RS02B887R0FE73](#) [RWR74SR604FRB12](#) [RWR89S6190FSB12](#) [RWR89SR237FRB12](#)  
[CPCC03R2000JB31](#) [CPW055R000JB143](#) [CPW103K300JE143](#) [CPW202R000JB14](#) [ULW5-39R0JT075](#) [W31-R47JA1](#) [VP25K-120](#) [VC3D900](#)  
[65888-3R3](#) [RWR81S4R64FRS70](#) [CB5JB10R0](#) [RWR81S1000FSB12](#) [RWR81S2R00FRB12](#) [CP000533R00JE66](#) [RWR84N5360FPB12](#)  
[VC3D.5](#) [SQM500JB-200R](#) [FW70A1000JA](#) [AC05000005608JAC00](#) [WA8505-47RJI](#) [75822-10R](#) [WHS201-68RJA25](#)