

Sensors and Controls

S O L U T I O N S G U I D E



Reliable Electronic Solutions

Index

<i>Bourns Sensors and Controls</i>	2	
<i>Potentiometers</i>		<i>Precision Multiturn Potentiometers</i>
Selecting a Potentiometer	7	
Modification Capabilities and Value-Added Solutions	9	
Array of Applications	11	
<i>Encoders</i>		<i>Precision Single-Turn Potentiometers</i>
Selecting an Encoder	15	
Modification Capabilities and Value-Added Solutions	17	
Array of Applications	18	
<i>Custom Solutions</i>		
Automotive Products	21	
Other Custom Products	24	
Integrated Front Panels	25	
Cursor Control	25	<i>Panel Controls</i>
<i>Application Notes</i>		
Potentiometers		
<i>Performance Characteristics</i>	27	
<i>Typical Applications & Circuit Configurations</i>	30	
Encoders		<i>Commercial Controls</i>
<i>Performance Characteristics</i>	34	
<i>General Application Information</i>	35	
<i>Application Information for EN Series Optical Encoder</i>	36	
<i>Product Selection Guides</i>		
Potentiometers		<i>Industrial Encoders</i>
<i>Precision Multiturn</i>	41	
<i>Precision Single-Turn</i>	47	
<i>Panel Controls</i>	51	
<i>Commercial Controls</i>	61	
Encoders		<i>Commercial Encoders</i>
<i>Industrial</i>	63	
<i>Commercial</i>	64	
Dials	65	
Hardware	66	
<i>Data Sheets</i>		
(All data sheets can be accessed through the links in the Product Selection Guides section beginning on page 41.)		
<i>Glossary of Terms</i>	67	<i>Integrated Front Panels</i>
		<i>Dials</i>

Introduction

The Bourns Mission

Our goal is to satisfy customers on a global basis while achieving sound growth with technological products of innovative design, superior quality and exceptional value. We commit ourselves to excellence, to the continuous improvement of our people, technologies, systems, products and services, to industry leadership and to the highest level of integrity.

Bourns Corporate

Bourns, Inc. has been providing reliable and innovative solutions to the electronics industry for over 50 years. With manufacturing facilities and customer support teams located throughout the world, Bourns is uniquely positioned to serve the industrial, automotive, telecommunications, audio/visual, aerospace and other electronic industries. Most importantly, Bourns is firmly committed to quality, service and innovation.

Sensors and Controls Headquarters

The Sensors and Controls Division is headquartered in Riverside, California. Since introducing its precision control line in 1970, Sensors and Controls now manufactures an extensive range of products. The product lines include Precision Controls, Panel Controls, Commercial Controls, Encoders, Turns Counting Dials, and a wide array of Custom Solutions for use in the industrial, medical, professional audio, consumer electronics and automotive industries.



BCLM production facility



Bourns Corporate headquarters in Riverside, California

World-Class Manufacturing

The majority of Sensors and Controls products are manufactured at the Bourns facility, Bourns de Mexico-CLM (BCLM), located in Tijuana, Mexico. The 58,000 square foot facility employs over 500 people and has been recognized with various quality awards from Ford and Motorola among others. The facility is ISO/QS certified since 1997 and has certified several employees through the six-sigma "Black Belt" program. With the implementation of the Bourns Production System, many of the employees are now involved in Kaizen events to further improve production efficiencies and reduce cost.



BCLM production line

Our core competencies in plastic injection molding and thick film printing combined with world class manufacturing facilities have contributed to the success of Sensors and Controls over the years. Market research feeds the continuous development of new models to meet the changing application needs and state-of-the-art performance requirements of the electronics industry. Continuing advances in materials-research and processing techniques have enabled Bourns to provide innovative product solutions to a growing customer base on a continuous basis.

Introduction

Quick Response Center

The “heart” of the Bourns Sensors and Controls operation located in Tijuana, Mexico, is the Quick Response Center (QRC). The QRC employs a technical base of engineers, technicians, and production personnel to process all customer inquiries and sample requests. Producing samples with modified features for application specific requirements in a relatively short time is the main focus of the QRC. By utilizing the sustaining engineering and fabrication departments, the QRC can modify parts produced to customer specifications and coordinate sample fabrication in production areas to insure the utmost quality and reliability. This process reduces cycle time and decreases response time to the customer. The QRC’s mission is quick response to the design needs of our customers.



BCLM Quick Response Center Team

Design Center

Using state-of-the-art design software and applying practical solutions to complex applications, Sensors and Controls Design Engineers develop and design products for the changing needs of the electronics industry. Working side by side with the Quick Response Center (QRC), the engineering team reviews feasibility of customer requirements,



Riverside Engineering Design Center

documents all new and modified designs on existing products, and coordinates prototype fabrication with the manufacturing facility. Our engineers work closely with customers to design cost effective and reliable solutions. Whatever your product needs may be, Sensors and Controls engineers can support your requirements.

Introduction

Reliability Test Facility

Once our engineering team has developed a product design, the Reliability Test Facility takes a major role to insure performance standards. The lab is equipped with specialized test equipment designed to run for thousands of hours, providing environmental, electrical and mechanical testing of potentiometers and encoders. Humidity, salt spray, rotational cycling, and exposure to high and low temperature extremes are just a few of the specialized tests performed on our products. In addition to testing finished products, our lab is set up to test individual piece parts, such as printed elements and windings, for endurance. The Reliability Assurance Test Program (RATP), which has a six-sigma quality goal, is evidence of our commitment to quality.



Riverside Reliability Test Facility

Commitment to Quality

Quality is the foundation of our products, starting with the acceptance of the customer drawing. Quality is continually being measured each and every time a Bourns® product is being put to use in every customer application. The Sensors and Controls Division has adopted the Six-Sigma Quality Program as the foundation of our business practice. Quality goes far beyond perfect parts, beyond quality control, to understanding zero-defects and how dependability affects our customer's customer. We are QS9000 certified and committed to consistent product reliability, assuring the highest yield of dependable, high performance products.

Bourns' successful commitment to quality is evident from the awards that the company has been received over the years. Some of the most recent awards include:

- *2002 – Invensys Bronze Supplier Award*
- *2002 – Tektronix Preferred Supplier Award*
- *2000 – Lucent APL Gold Award*
- *2000 – TTI Supplier Excellence Award*

Introduction

Technical Support

Trained sales representatives, account managers and distributor sales engineers are located conveniently around the world. Our Field Application Engineers (FAEs) are also strategically located to assist with technical support and to provide an interface between customer inquiries and our production facility. Our technical support team can provide you with solutions appropriately selected and precisely manufactured to satisfy your requirements for performance, cost and availability.

Customer Service

Bourns' distributor network is the most extensive in the industry. Our three Bourns Customer Service Centers located in the US, Europe and Asia, as well as our extensive distributor network, are dedicated to serve you on any aspect and demand. With 100 % on-time delivery and world-class service as core business objectives, we ensure direct support for customers in all countries and market segments. At Sensors and Controls Division, we strive to build good business relationships with our customers.

In every aspect from innovative designs to on-time delivery, Bourns Sensors and Controls is the first choice in the industry for reliable and cost-effective potentiometers, encoders and custom solutions.





POTENTIOMETERS

Potentiometers

Selecting a Potentiometer

The Sensors and Controls Division has a potentiometer to fit many of your applications. Whether you need a precision control with millions of rotational life cycles or a commercial potentiometer that fits in a hand-held radio, we have a product selection that is second to none. No other manufacturer offers a broader selection of potentiometers than Bourns Sensors and Controls.

Types of potentiometers in the Sensors and Controls product line include:

- *Multiturn Precision*
- *Single-Turn Precision*
- *Panel Control*
- *Commercial Grade*

Precision Potentiometers are used to provide an accurate electrical output signal corresponding to a mechanical position input, where accuracy, reliability and long life are important. These devices are generally designed for high reliability, long life in continuous service, high accuracy and operation in demanding environments.

Panel Control Potentiometers are used where the frequency of adjustment is high and front panel accessibility is required. These industrial grade devices are designed for long rotational life with emphasis on good adjustability.

Commercial Potentiometers are used in consumer applications as lower cost alternatives to industrial grade panel controls. These devices are designed for moderate rotational life with emphasis on low cost.

In selecting a potentiometer for your application, the most important characteristics to consider are the type of element (cermet, conductive plastic, carbon, wirewound and Hybritron®) and expected cycle life of the product.

Cermet Element Technology

Cermet elements are available in a wide range of resistance values and tapers. They offer essentially infinite resolution and excellent stability in the most severe environmental conditions. Static and dynamic noise (CRV) performance is good, although conductive plastic is better. The temperature coefficient of cermet elements is better than conductive plastic or carbon type elements, though not as good as wirewound elements. Linearity is good but can be improved in accuracy by utilizing laser-trimming technology. Frequency response of cermet materials is very good. The practical application range extends well beyond 100 MHz.



Conductive Plastic Element Technology



Conductive plastic thick film ink is similar to cermet, but has a smoother surface. This characteristic offers several operational advantages over cermet. Dynamic noise characteristics (CRV or output smoothness) and rotational life are measurably improved and resolution is essentially infinite. Conductive plastic elements are generally available in a wide range of resistance values and tapers. Moisture resistance, temperature coefficient, power dissipation and wiper current capacity for conductive plastic elements are not as good as cermet elements.

Carbon Element Technology

Carbon elements offer the most cost-effective technology. A carbon-based resistive ink is screened or sprayed onto a phenolic or FR4 substrate. Resistance ranges are limited, beginning with 1 k Ω and going as high as 1 M Ω . Potentiometers using this element technology are typically for commercial type applications, with rotational life in the 10,000 to 15,000 cycles range.



Potentiometers

Wirewound Element Technology

Wirewound elements offer good stability, excellent linearity, low noise, high power capabilities and good operational life. Wirewound elements offer a wide range of resistance values up to 500 k Ω . One

primary limitation of wirewound elements is the finite resolution steps, which result from the wiper moving from turn to turn perpendicular to the coil of wire. (These steps are distinct, sudden, repeatable changes in output.) Resolution

improves as resistance values increase due to the manufacturing processes whereby smaller diameter wire and a higher number of turns are utilized. For applications that may be sensitive to such discrete steps, care should be taken to select an element with resolution fine enough to avoid difficulty.

The coil of resistance wire used to fabricate a wirewound element exhibits an inductive reactance that increases proportionately with the frequency. This effect is most noticeable in the lower total resistance elements where the inductive reactance can be larger than the resistance, even at frequencies as low as 20 kHz. The performance of wirewound elements is also affected by inherent capacitance. Capacitance exists from turn to turn and also between the winding and the mandrel. The effects of capacitance are most significant in the higher total resistance elements.

Hybritron® Element Technology

This element is a wirewound element with a conductive plastic coating. It exhibits the temperature coefficient and resistance stability similar to a pure wirewound element. In addition, it displays the long operational life, essentially infinite resolution and low noise characteristics of the pure conductive plastic elements.

The combination of the two provides the major benefits of both types of elements. This element is not recommended in applications requiring high wiper currents.



Mechanical Cycle Life

Mechanical cycle life is the ability of a potentiometer to withstand a specified number of cycles under specific operating conditions, while remaining within allowable specifications. A mechanical cycle consists of wiper traverse from one limit of travel to the other limit, and back. The performance is determined by the type of resistive element and wiper used in the construction of the potentiometer.

Precision Potentiometers are generally capable of mechanical cycle life in the range of 300,000 to 25,000,000 shaft revolutions.

Panel Control Potentiometers are generally capable of mechanical cycle life in the range of 25,000 to 100,000 full cycles.

Commercial Potentiometers are generally capable of mechanical cycle life in the range of 10,000 to 25,000 full cycles.

The actual mechanical cycle life or rotational life will heavily depend on the environmental and electrical stresses imposed on the unit during its life.

Additional information on performance characteristics and applications is contained in the "Application Notes" section of this guide.



Potentiometers

Modification Capabilities and Value-Added Solutions

The strength of Bourns Sensors and Controls product line lies in the customized or modified potentiometers to suit your application. A wide range of “value-added” potentiometer enhancements is also available to provide you with cost-effective solutions. We appreciate the opportunity to explore your application and provide potentiometers modified to meet your exact needs.

Bourns’ capabilities to develop custom potentiometer solutions and modifications include the following:

Terminal Configurations

Terminals can be customized.



Hardware

Most products are shipped with one hex nut and one lock washer, with other configurations available on request.



Bushing and Servo Mount

Bushings can be modified to add a flat, provide special thread pitch, or even custom lengths. Servo mount versions can be substituted on many bushing mount models.

Seal

Many models are sealed for board processing. Some models can be sealed to IP65 specifications.

Special Test Requirements

Bourns has the capability to provide extensive reliability testing as required. We can accommodate most special test needs along with test documentation and/or certification with each shipment as requested.



Cable Harness or Lead Wires

For ease of connection to your application, we can supply a custom fit cable harness or lead wires with a mating connector.

Marking

Standard marking includes the Bourns part number and date code. We can mark additional information, such as customer name and part number, or any other designations.

Special Packaging

Bourns will provide custom packaging to meet your production or storage needs.

Customized Shaft Options

In all shaft diameters, Bourns can modify the length of the shaft, add a flat with special shaft orientation, add holes or notches, or even press on a gear as a value-added option.



Mounting Brackets

Bourns can develop a customized bracket. Servo mount precision controls can use motor mount cleats or precision synchro mounting clamps by Pic Design. (www.pic-design.com)

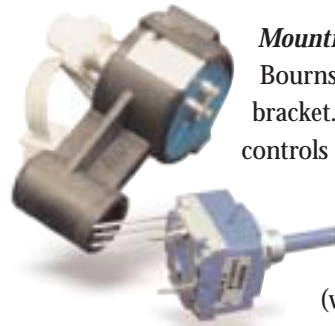

Some additional customizing features *solely applicable to potentiometers*:

Switches

Rotary switches are available as a standard feature on many panel control models.

Push switches can be added to meet your specific needs.



Potentiometers

Special Tapers

We can provide custom tapers on our non-wirewound panel controls and precision potentiometers.



Front and Rear Ball Bearings

Bourns offers additional ball bearing configurations not listed in our data sheets to accommodate unique applications with heavy shaft side load. This option is typically used with our 65xx and 66xx single-turn precision controls.

Independent Linearity

Our wirewound and single-turn precision potentiometers can be ordered with special linearity from 0.1 % to 2.0 %.

Temperature Ratings

Bourns offers special potentiometer configurations made to withstand temperature extremes.



Center Tap

We can add a fourth terminal (center tap) for measuring current or voltage.

High Torque

Running torque variations available in 2 to 8 oz-in for a smooth, heavy feel.

Dual Wipers

Our precision controls 65xx and 66xx models can be produced with dual resistive tracks and dual wipers.

Rear Shaft Extension

This option is available on many models, and is most popular on a multiturn wirewound potentiometer, but is available on panel control models as well.

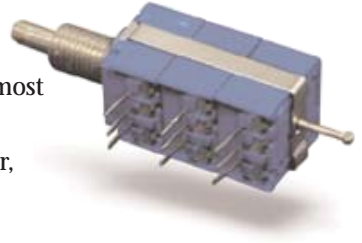

Mechanical & Electrical Angles

We can provide custom mechanical and electrical angles. Electrical angles are typically smaller than their corresponding mechanical angles.

Multi-Section Potentiometers

This feature is available on many panel control and precision potentiometer models. These devices can be configured with one shaft to control multiple ganged potentiometers, or a dual concentric shaft for individual adjustment.



Potentiometers

Array of Applications

Bourns® potentiometers can be found in a broad array of applications and functions. For over 50 years, Bourns has provided technical leadership in the potentiometer market. Our engineering and design expertise have provided customers solutions to applications in the following areas:

Transportation

A fast growing marketplace, manufacturers are taking advantage of long life precision potentiometers used as position feedback sensors in rugged transportation systems.



- *Aircraft Systems*
- *Rocket Guidance Systems*
- *Agriculture & Construction Equipment*
- *Traffic Control Systems*
- *Training & Simulation Equipment*
- *Locomotive Braking Systems*
- *Forklifts*
- *Joystick Controls*
- *Automotive Comfort Controls*
- *Motorized Golf Carts*

Medical

State-of-the-art medical equipment requires a reliable electronic solution that will withstand the use and abuse of daily wear. Bourns® potentiometers, used as human interface controls, or sensors in non-critical life support applications are designed to outlast the equipment life.

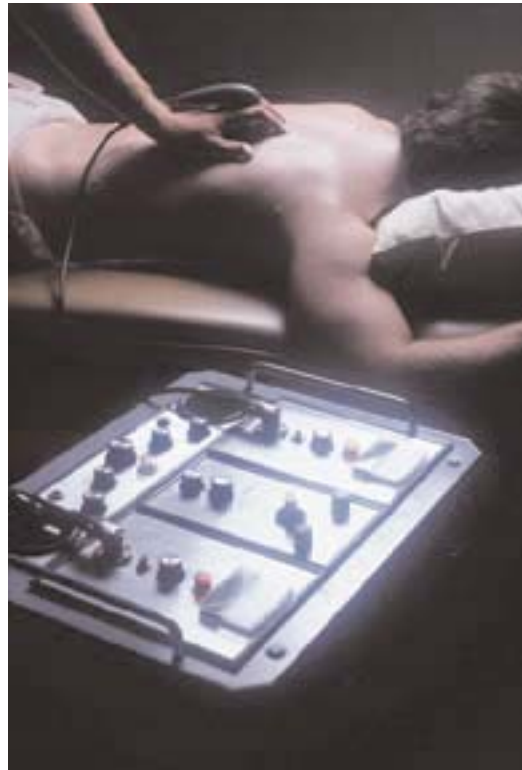

- *Dental Equipment*
- *Electric Wheelchairs*
- *Analytical & Diagnostic Equipment*
- *Hospital Bed Controls*
- *Positioning Controls for X-Ray*

Potentiometers

Industrial Controls

Bourns® precision potentiometers have played a key role in industrial control systems for many years. Dependable and accurate, Bourns® potentiometers should be your first choice for your most robust and

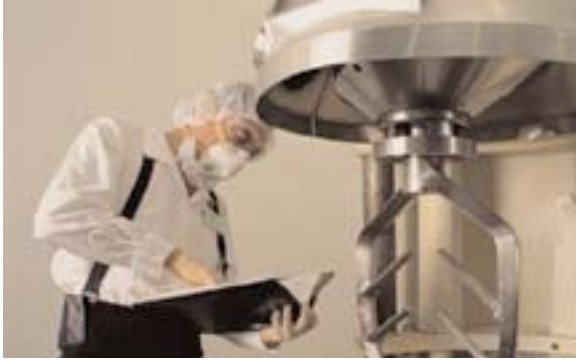

demanding applications.

- HVAC Equipment
- Illumination and Theater Controls
- Meteorological Equipment
- Oil Exploration & Refinery Equipment
- Manufacturing Control Systems
- Machine Tool/Presses/Vision Systems
- Robots/Robotic Equipment
- Dispensing Process Equipment
- Controls for Printing Presses
- Food Processing Equipment
- Automatic Doors/Gates
- Automated Warehouse Equipment
- Speed/Adjustment Controls

Professional Audio

As a leader serving the professional audio market, Bourns® controls are used for volume, balance, and



tone controls in professional audio equipment today.

- Studio Recording Equipment
- Mixing Consoles
- Broadcast Equipment
- Keyboards
- Amplifiers
- Commercial Audio Sound Systems

Instrumentation

On a panel in selector mode, or inside the cabinet as a sensor, Bourns® potentiometers are an excellent choice for all types of instrumentation.

- Oscilloscopes
- X-Y Plotters
- Fluid Level Sensors
- Aircraft Lighting Systems
- Helicopter Communication Systems
- Test & Measurement Equipment



Potentiometers

Commercial Appliances

Bourns has developed many controls for the expanding electronic appliance industry. We can modify any of our potentiometers to meet these robust commercial applications.

- *Laundry*
- *Refrigeration*
- *Oven Ranges*
- *Hand Mixers*
- *Food Processors*

Consumer Electronics

Bourns® potentiometers continue to get smaller as the demand for portable equipment increases. Take a look at all the models we have to offer for this growing consumer electronics industry.

- *Computer Speakers*
- *Car Audio*
- *Dictation Equipment*
- *Film Development Processors*
- *Graphic Applications & Simulation*
- *Joy Sticks*

To assist you in making the right potentiometer selection for your application, please refer to the sections in this guide entitled “Application Notes” and “Product Selection Guides.” These sections provide a side-by-side comparison of specifications for each model along with technical data for each model. Additional technical information can be found in the “Data Sheets” and “Glossary of Terms” sections.

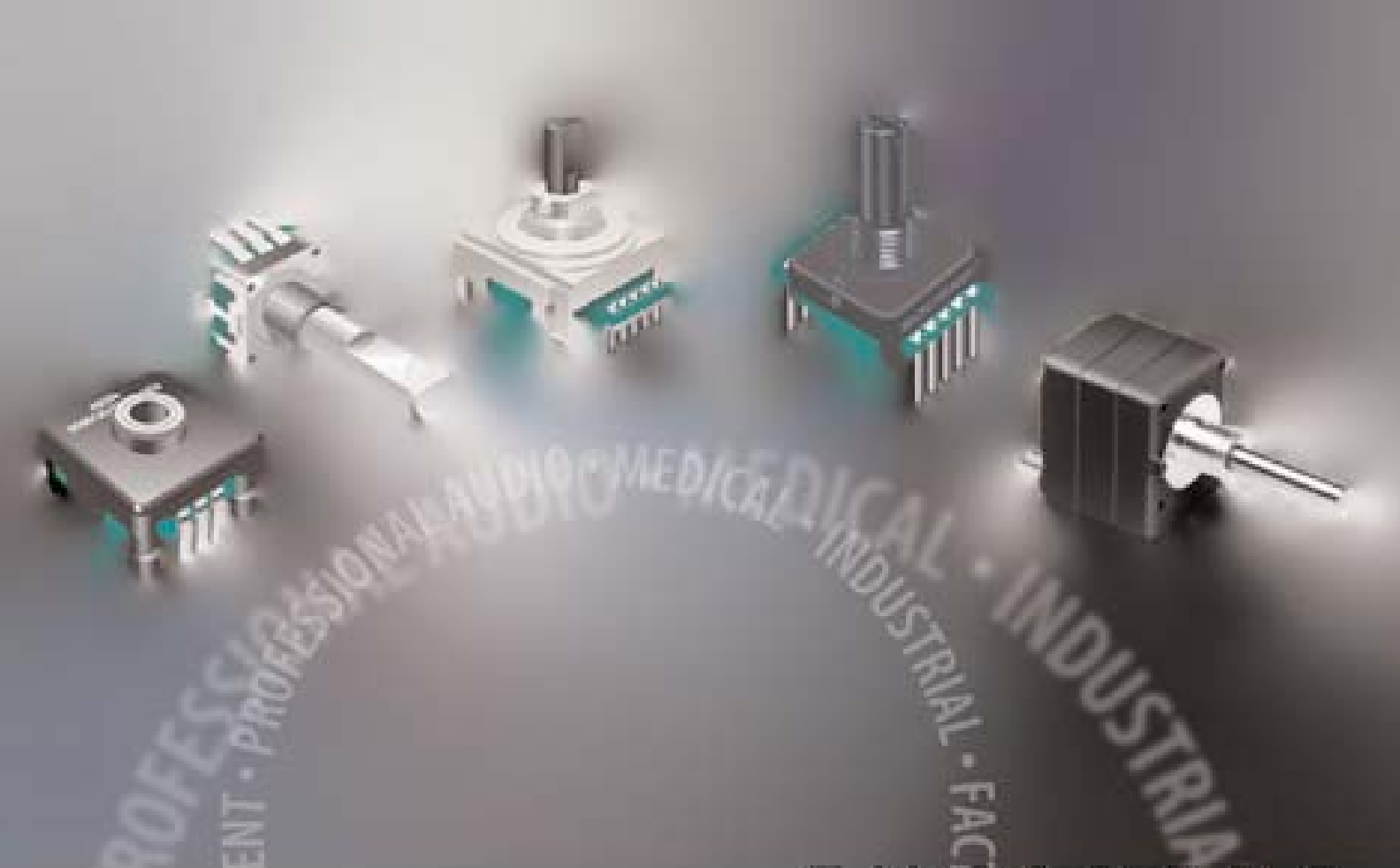

ENCODERS

Encoders

Selecting an Encoder

With Sensors and Controls offering more than 10 different models of encoders, we have one to fit your applications needs. Providing the industry with both contacting and non-contacting encoders, Bourns is recognized worldwide for supplying standard and custom encoder solutions and providing excellent technical support.



An encoder is a rotary or linear device that detects or senses a change in position resulting in a digital signal output.

These devices are also known as Incremental Encoders, Digital Panel Controls, Bit Switches, Gray Code Switches and Digital Switches.

Rotary encoders are physically similar in appearance to a potentiometer. However, the electrical function of an encoder is different than a potentiometer. Encoders are used in applications from car radios to automatic door openers as position sensing digital switches. Some of the functions that the Bourns® encoders can be used for are:

- *Identifying direction of rotation*
- *Detecting angular position*
- *Up/down counting*
- *Sensing speed of rotation*
- *Pulse generation*
- *Switching*

An advantage of using encoders over potentiometers in a digital circuit is that the signal produced by an encoder eliminates the analog-to-digital (A/D) conversion process. This approach can reduce memory overhead, wiring and wiring interconnects, and can provide greater MPU program speed.

Important Characteristics

In selecting an encoder for your application, the most important characteristics to consider are the type of technology, type of output signal, speed of rotation, expected cycle life and switching capability of the product. There are two basic technology classifications of encoders: contacting (mechanical) and non-contacting. Your application will dictate the type of technology that will be best suited for your design.

Contacting Technology

Contacting encoders have two major components in their construction: the coded element and a contacting sensor or wiper. Movement of the wiper over a coded element emulates a mechanical switching action, producing a digital output signal. This type of technology offers the most cost-effective solution for your application. However, resolution and rotational life are limitations of contacting designs. Bourns offers a variety of contacting encoder models suited for low cost applications.



Non-Contacting Technology

Non-contacting encoders can be constructed from four different types of technologies: optical, inductive, capacitive and magnetic. Optical encoders contain three major components in their construction: a light source, a code disk, and a detector. Resolution and life are much higher than the contacting technology. Optical encoders can be used in both static and dynamic applications. This type of encoder offers a midrange priced solution for your application. Magnetic encoders contain three major components in their construction: a coil, a magnet, and a sensor. Magnetic encoders can operate in very high-speed and high temperature applications. However, resolution is limited for an equivalent sized optical encoder package. This type of encoder is used in dynamic applications only and is a high priced component. Bourns offers optical encoders suitable for your applications.

Encoders

Types of Output Signals

There are two basic types of encoder output signals: incremental and absolute. The incremental signal consists of two phase-shifted, square-wave signals. The phase shift is required for recognition of the direction of rotation. The absolute signal, also known as Gray Code, consists of discrete coded binary values and may be from 4 to 16 bits wide. In application, absolute encoders are required if a particular setting must be recognized and available after a power down of the system. All other applications can use an incremental encoder.

Speed of Rotation

Contacting encoders have a higher sensitivity to speed of rotation or revolutions per minute (RPM). On the other hand, non-contacting encoders can be rotated at high speeds. Contacting encoders begin to skip counts when the shaft is rotated in excess of 100 RPM, while non-contacting encoders fitted with ball bearings can be rotated at speeds up to 3000 RPM.



Rotational Life

Contacting encoders have a limited rotational life due to wear on mechanical contact components used to create the signal output. In general, contacting encoders have a rotational life below 100,000 cycles. On the other hand, non-contacting encoders can endure rotational life in excess of 1,000,000 cycles. Non-contacting encoders are theoretically limited by the wear in bearing surface of the bushing or ball bearings holding the shaft in place. Typical cycle life expectancy is 10 million without ball bearings and 200 million with ball bearings.



Switching Capability

Encoders are frequently used in switch applications where each discrete bin number in the output signal is recognized as a specific instruction or setting for the digital system. In such cases, the system must recognize the position of the encoder after power down of the system. For those applications, encoders such as Bourns® Model EA Absolute Contacting Encoder (ACE™) are the perfect solution. Incremental contacting encoders can also be used in such applications. However, the designer must make additional software and hardware provisions for retaining the encoder position in a non-volatile memory.



Another frequently used option available in many encoder models is the momentary push switch. This type of switch is typically used to drive menu selection in a digital display. Bourns offers the model EP and PEC series encoders with momentary push switch options to suit your application.

Additional information on performance characteristics and applications is contained in the “Application Notes” section of this guide.

Encoders

Modification Capabilities and Value-Added Solutions

The Sensors and Controls Division has continued to expand its encoder product offering with a wide variety of models to meet your application needs, including both absolute and incremental quadrature output codes. A wide range of “value-added” potentiometer enhancements is also available to provide you with cost-effective solutions. We would like the opportunity to provide a custom solution to meet your application and design needs.

Bourns’ capabilities to develop custom encoder solutions and modifications include the following:

Cable Harness/Lead Wires

For ease of connection to your application, we can supply a custom fit cable harness or lead wires. We can even supply it with a mating connector.



Detents

On some models, the detent count can be doubled or quadrupled per electrical output cycle.

Custom Output

In addition to our standard electrical output (PPR), custom outputs signals can be developed to meet special application needs.

Seal

Some models are sealed for board processing. Some models can be sealed to IP65 specifications.



Torque

On some models, rotational torque can be increased for a smooth, heavier feel.

Special Packaging

Bourns can provide custom packaging to meet your production or storage needs.

Terminal Configurations

Terminals can be formed to meet your application needs.



Hardware

Most products are shipped with one hex nut and one lock washer, but other configurations are available upon request.

Marking

Standard marking includes the Bourns part number and date code. We can mark additional information, such as customer name and part number, or any other designations.

Mechanical Stops

All encoders are continuous turn, but stops can be added to limit mechanical travel.

Mounting Brackets

Bourns can develop a customized bracket to meet your needs. Servo mount precision controls can use motor mount cleats or precision synchro mounting clamps by Pic Design. (www.pic-design.com)

Special Test Requirements

We have the capability to provide extensive reliability testing as required. We can accommodate most special test needs along with test documentation and/or certification with each shipment as requested.

Customized Shaft Options

In all shaft diameters, Bourns has the ability to modify the length of the shaft, add a flat with special shaft orientation, add holes or notches, or even press on a gear as a value-added option.



Encoders

Array of Applications

Bourns Sensors and Controls offers a wide range of encoder package options and performance characteristics unmatched by competitive devices. This extra measure of adaptability makes Bourns® encoders the optimum solution for a broad range of applications. Our engineering and design expertise used to resolve customer needs have led us to encoder applications in the following industries:

Professional and Consumer Audio

An industry leader serving the professional and consumer audio market, Bourns' contacting and optical encoders can be found in all types of audio applications. Old analog designs are being redesigned with to digital circuits with encoders replacing potentiometers.



- *Studio Recording Equipment*
- *Digital Mixing Consoles*
- *Digital Broadcast Equipment*
- *Professional Sound Systems*
- *Digital Amplifiers*
- *Digital Car Audio*

Test & Measurement Equipment

Used as input devices for all types of test and measurement equipment, contacting and optical encoders provide accurate adjustment controls insuring reliability and dependability in your end product.



- *Oscilloscopes*
- *Digital Analyzers*
- *Measurement Instruments*
- *Weather Instruments*
- *Medical Diagnostic Equipment*
- *Chart Recorders*
- *Digital Monitors*

Encoders

Industrial/Factory Automation

Optical Encoders are a rugged and durable solution for factory automation and industrial uses. With millions of life cycles, non-contacting technology enables these encoders to outlast the life of the equipment. Designed with outputs to 256 pulses per revolution, Bourns® optical encoders provide the highest resolution with the smallest package size in the industry.

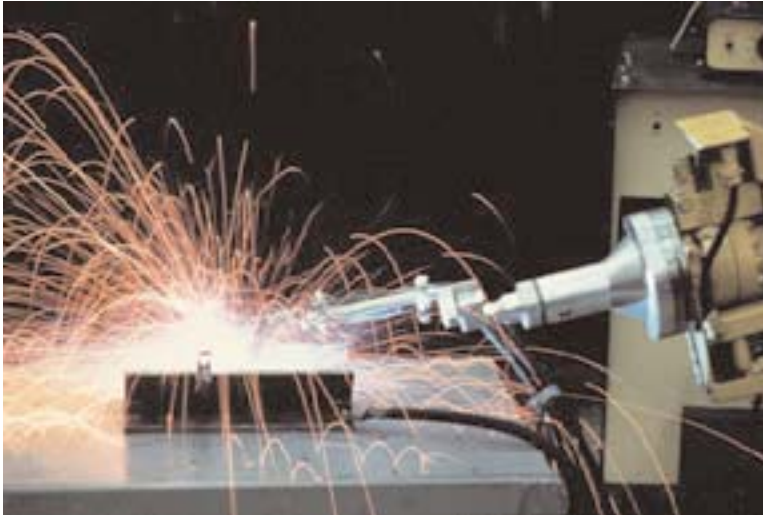

- *Robotics*
- *Material Handling*
- *Forklift Trucks*
- *Machine Tools*
- *Automated Gates/Doors*
- *Fluid Measurement*

To assist you in making the right encoder selection for your application, please refer to the sections in this guide entitled “Application Notes” and “Product Selection Guides.” These sections provide a side-by-side comparison of specifications for each model along with technical data for each model. Additional technical information can be found in the “Data Sheets” and “Glossary of Terms” sections.

SMART POTENTIOMETER • AUTOMOTIVE PRODUCTS

CUSTOM SOLUTIONS

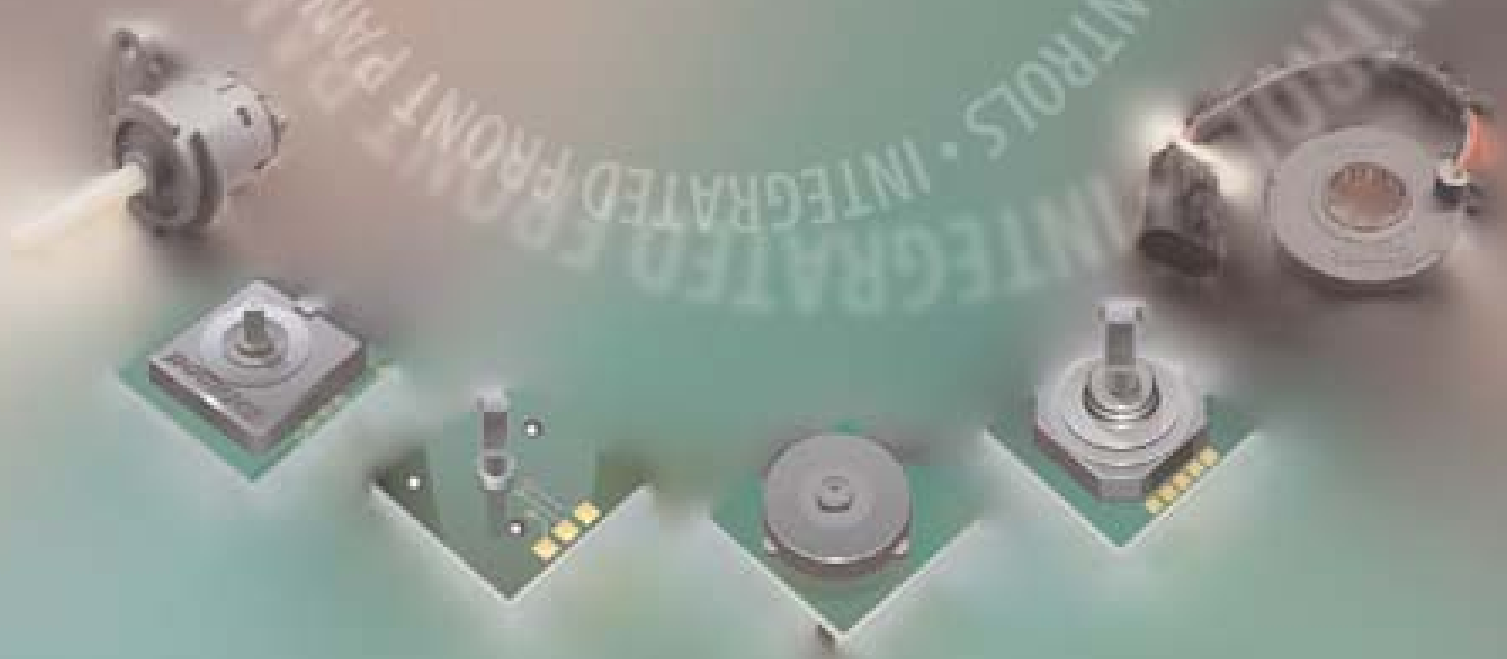

Custom Solutions

Automotive Products

Many of the world's leading manufacturers have long known Bourns as a company that they can trust to deliver quality electronic parts on time and within target costs. With components and integrated solutions for many automotive applications, Bourns Sensors and Controls has a keen sense of automotive companies' needs. Our products deliver performance and reliability you can trust.



Bourns has been an integral part of many recent technological advances providing high-performance, low-cost, magnetic position sensors, and enhancements to positive temperature coefficient over-current protection devices.

At the Sensors and Controls Division, we understand that automotive manufacturers need complete solutions. To achieve an optimum blend of price and quality, we are structured to be one of the world's most vertically integrated suppliers. With our own prototype engineering labs and tool rooms, we are able to minimize the time to market. From simple substrates to complete assemblies, Bourns does it all. Our component offering is exceptionally broad-based.



Bourns automotive offerings include sensors, overcurrent protection devices, controls, and discrete components. The breadth of Bourns standard product offering is unmatched in the passive electronics industry. At the same time, our vertical integration, production capacity, and technical expertise gives us the ability to adapt quickly to just about any custom requirement. This unbeatable versatility continues to make Bourns a supplier of choice for many automotive manufacturers. Simply contact your local Bourns sales representative for assistance on your automotive needs.



Bourns Automotive Engineering Group has designed, prototyped, and manufactured customized automotive sensors for tier one and tier two automotive customers over the last 25 years. With everything from contacting type encoders for automobile radios, including the more recent use of new non-contacting magnetic technology in throttle position sensors and electronic throttle control applications, Bourns can provide you with the custom discreet and integrated solutions needed in today's changing automotive marketplace.

Custom Solutions

Bourns core technologies can be tailored to fit any sensor application. These technologies include:

- *Thick Film Printing*
- *Long Life Resistive Ink Technology*
- *Non-Contacting Magnetic Technology*
- *Insert and Injection Molding*
- *CNC Machining*
- *Metal Fabrication*



Bourns Automotive Engineering Group has been successful in developing the following types of components for the automotive industry:

- *Brake Wear Sensors*
- *Steering System Sensors*
- *Gear Position Sensors*
- *Single/Dual Output Non-Contacting Pedal Position Sensors*
- *Non-Contacting Linear and Rotary EGR Sensors*
- *Non-Contacting Rotary Throttle Position Sensors*
- *Electronic Transmission Sensors*
- *Suspension Position Sensors*
- *Memory Seat Controls*
- *Radio Controls*
- *HVAC*

Whatever your automotive sensor or control requirement may be, Bourns Automotive Engineering Group has the expertise to design, prototype, and manufacture it for you. Simply contact your local Bourns Sales Representative with details of your idea or design, and they will do the rest. Like millions before you, Bourns

will be happy to provide you with the most Reliable Electronic Solutions the industry has to offer.



Custom Solutions

Custom Solutions for Automotive Applications

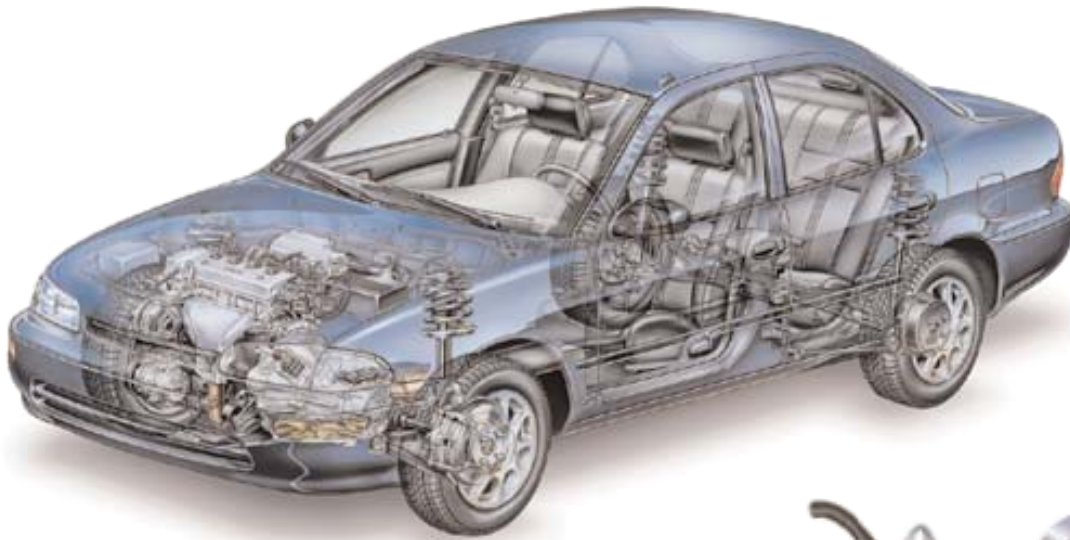

Dimming System
• 3310 Panel Control



Stability Systems
• Suspension Sensors
• Steering Sensors
• Brake Wear Sensors



Cockpit Systems
• HVAC Controls
• Radio Controls
• Integrated Electronic Front Panel Solutions
• Infotainment Electronic Solutions



Engine Management Systems
• Throttle Position Sensors
• Pedal Position Sensors
• EGR Valve Position Sensors
• Transmission/Gear Position Sensors

Custom Solutions

Other Custom Products

The Sensors and Controls Division specializes in designing, developing and manufacturing custom components, utilizing both contacting and non-contacting technologies. From throttle position sensors for a unique automotive environment, to printed circuit boards custom fitted with Bourns® contacting encoders, we aid customers in developing their ideas into assembly ready solutions. Bourns can fully integrate passive and active components into an array of housing sizes to meet customer needs.

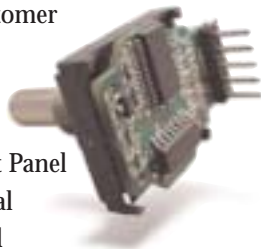

One example of a custom solution is the Bourns® Smart Panel Control. This device is a digital rotary control with embedded functionality facilitated by on-board electronics. The product may be programmed to accommodate a variety of different functions. Specifically, it can control several devices and all associated functions through one simple, intelligent interface.

Another Smart Panel Control configuration directly controls and powers a small DC motor for an automotive or industrial application. Variables such as speed, slew rate and control curve can be programmed into the on board electronics. The Smart Panel Control may also monitor all systems and under program control either notify the operator of the offending condition, or take direct action.



With Bourns' core manufacturing competencies in precision injection molding, metal fabrication, resistive ink development and high volume resistive ink printing, we can cost-effectively meet your application needs. Simply contact your local Bourns Sales Representative to start the process.

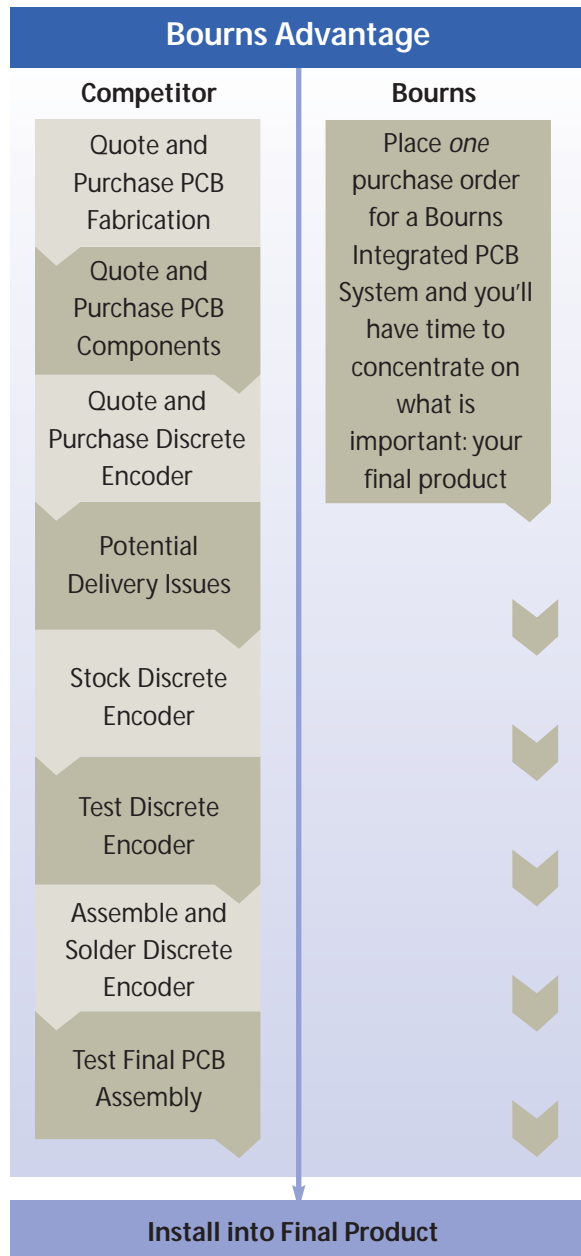

Diagram1: The Bourns Advantage

Custom Solutions

Integrated Front Panels

An Integrated Front Panel (IFP) is a custom solution designed by the Sensors and Controls Engineering Group where a printed circuit board is populated with encoders and additional components providing the customer with a cost-effective solution.

“Integrated” refers to Bourns® contacting encoders integrated directly onto the board, using the board surface as the encoder element through a patented process.



Previous applications have included between 7 and 11 contacting encoders on a surface mount technology (SMT) or a through-hole printed circuit board. An advantage of

this technology is the opportunity to upgrade to SMT versus a through-hole design. IFPs can be designed with either front mounted encoders or rear mounted encoders allowing for extra space to accommodate additional components. This design versatility allows for higher component density, freeing up valuable board real estate. IFP systems provide a simplified, cost-effective “plug and play” solutions for our customers.

The IFP System Advantage

The Engineering Group at the Sensors and Controls Division has developed a cost-effective and time saving custom solution for you. IFP provides you with a total solution: integrating the encoders directly to your printed circuit board, populating the board with additional components, testing the final product, and delivering the total package to you.

The IFP System gives you an advantage over your competitor by allowing you to place one purchase

order and receive one shipment. All you do is plug it into your system and turn it on. (See Diagram 1 on page 24.)

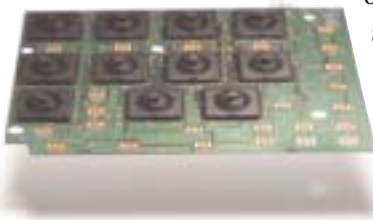

Partnerships with our Customers

As part of a joint effort to solve a customer assembly problem, Bourns designed and developed custom integrated encoders that mount directly onto the customer’s printed circuit board. This process and technology are now available for all customers. Available in three versions, front mount, front mount with push momentary switch, and rear mount, Bourns can efficiently reconfigure your current printed circuit board from a through-hole design to a surface mount version and integrate encoders as part of the circuit board.

This custom encoder solution provides long operating life, consistent feel, and space saving benefits. Produced in ISO certified manufacturing facilities, Bourns provides full turnkey service with procurement and total assembly of all your discrete electronic components, along with our integrated encoders. We ship a fully tested and assembled unit, truly a plug and play solution. Additional information can be found in the section entitled “Data Sheets.”

If you currently use three or more encoders on your panel design, we can customize an IFP to your specifications. Contact your local Bourns Sales Representative today.



Cursor Control

A Cursor Control is a solid, ceramic two-axis or three-axis force sensor based on a thick film technology innovation. This revolutionary design provides a distinct linear output in all three axes, resulting in smooth motion control. The compact size is ideally suited for applications where space is a major constraint. This family of sensors addresses emerging customer needs for long life and reliability with a very attractively priced product offering.

NOTE: Cursor Control products, previously offered by Bourns, are now available through Synaptics Inc., San Jose, CA. For additional information, please visit their website at www.synaptics.com.



APPLICATION NOTES

Application Notes

Potentiometers

Performance Characteristics

The following section discusses various performance characteristics to be considered when selecting a potentiometer along with typical applications and basic circuit configurations.

Power Rating

Power rating is the maximum heat that can be dissipated by a potentiometer under specified conditions with certain performance requirements. Heat (or power) dissipation is the result of current passing through a resistance. The useful life of a given potentiometer is directly related to the maximum temperature allowed in the interior of the unit. Above a certain internal temperature, insulating materials begin to degrade. A maximum power

rating indicates to the circuit designer how much power may be safely dissipated without harm to the device.

Taper

A taper is defined as the output curve of resistance, measured between one end of the element and the wiper. It is expressed in percent of total resistance versus percent of effective rotation. Sensors and Controls precision wirewound products and precision single-turn potentiometers are available in linear taper only. Linear taper is the percent of effective electrical clockwise rotation equal to the percent of voltage ratio output, creating a linear output. Audio taper produces a change in output on a logarithmic scale giving the human ear the perception of sound intensity increasing in a linear mode. All other Bourns® potentiometers are available in a variety of standard tapers, including audio and reverse audio. Custom tapers are available; consult the factory for complete details and minimum order quantities. Table 1 provides an easy reference for taper codes on all Bourns® panel control models. Figure 1 shows the most frequently requested tapers ranked by most popular:

Models	Taper Codes			
	1	2	3	4*
39	B	D	G	
50 Series	A, H, B, E	C, D, S	F, G, T	
80 Series (81, 82, 85, 86)	A, H, B, E	C, D, S	F, G, T	
80 Series (83, 84)	J, K			
90 Series	A, H, B, E	C, D, S	F, G, T	
3310	Linear only			
3851, 3852, 3856	A, H, B, E	C, D	F, G	
3862	A, H, B, E	C, D	F, G	
PCW	B	D	G	
PDA17	B	A		
PDB12	B	A		
PDB18	B	A		
PTV09	B	A		
PTV111/PTT111	B	A		
PTV142	B	A		
PTD90/PTR90	B	A		
PDV	B	A		
PTA	B	A		
PTB	B	A		

Notes:

- Please refer to the datasheets for more information on taper codes
- *Custom parts only
- All precision potentiometer models are available in linear only.
- "S" taper and other tapers are available by special order.

Table 1: Taper Codes by Model

- 1 = linear taper
- 2 = audio or log taper
- 3 = reverse audio or reverse log taper
- 4 = modified linear or "S" taper

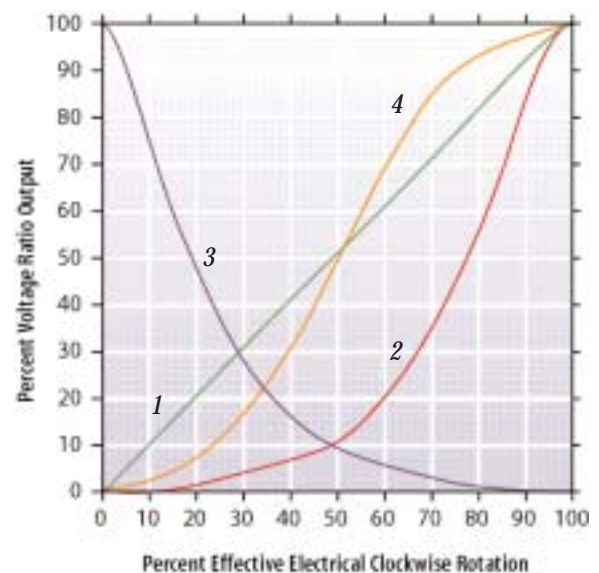

Figure 1: Popular Tapers

Application Notes

Temperature Coefficient of Resistance

The temperature coefficient of resistance (TCR) is an indication of the maximum change in total resistance that may occur due to a change in ambient operating temperature. This parameter is normally specified in parts per million per degree Celsius (PPM/°C). Temperature coefficient is dependent on the type of material used to construct the resistive element and the physical structure of the unit. Potentiometers constructed with cermet, conductive plastic or carbon elements typically have a higher temperature coefficient than those constructed with wirewound elements by approximately twice the value.

Wiper Load

The wiper load must always be specified carefully, as it has a great effect on the wiper output. Unless otherwise specified, Bourns assumes the resistance wiper load to be at least 100 times the value of the potentiometer per the industry standard. In specifying the wiper load, keep in mind that if the current load is too high, linearity will degrade. With conductive plastic elements, excessive wiper load will increase the negative effects of contact resistance and

contact resistance variation (CRV). The rule of thumb for selecting the wiper load is to use the ratio of total resistance (RT) to wiper load (RL) of 1:100 or higher (see Figures 2 and 3.)

The following tables will guide you in selecting the correct type of potentiometer for your application.

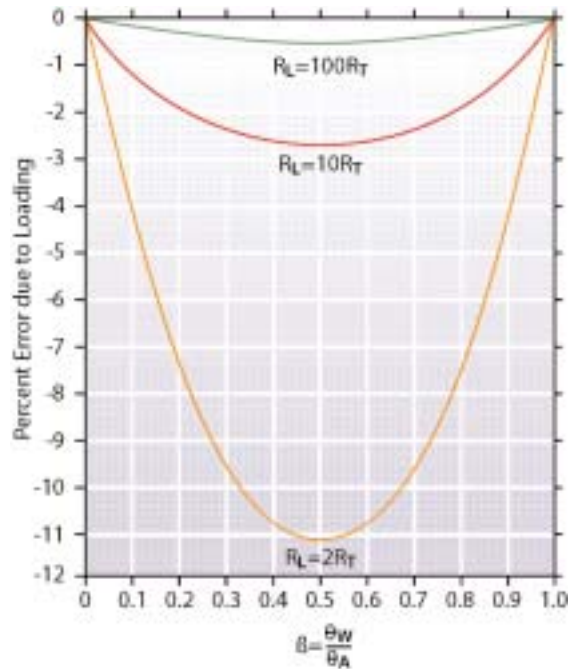

Figure 3: Linearity Affected by Load

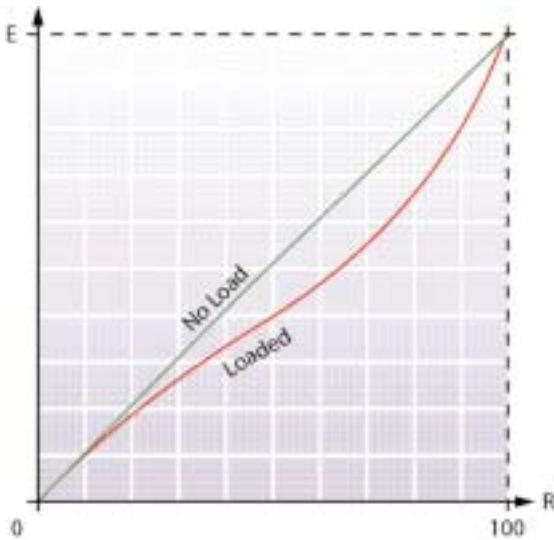

Figure 2: Error Due to Wiper Loading

Application Notes

Precision Potentiometers												
Element Technology				Characteristics	Typical Applications							
Cermet	Conductive Plastic	Hybitron®	Wirewound		Closed-Loop Servo	Multiple-Input Position Sensor	Shaft Angle Sensor	Reg Power Supply Voltage Control	RC Freq Control (Calibrated)	RCL Bridge Null Control	Sweep Delay Control	
1	2	2	2	Resistance Range	L	L	L	M	M	L	M	
2	3	2	1	Resistance Tolerance	L	L	L	M	M	H	M	
2	3	2	1	Temperature Coefficient	M	L	L	M	M	H	M	
1	3	2	1	Power Dissipation	L	L	L	L	M	M	M	
3	2	2	1	Noise/CRV	M	M	M	L	M	L	M	
1	1	2	3	Resolution	M	M	M	M	M	M	H	
2	2	2	3	Adjustability	M	M	M	M	M	M	H	
1	2	2	1	Moisture Stability	H	H	M	H	M	M	M	
2	2	2	1	Linearity	M	H	H	H	H	H	H	
4	1	2	4	Rotational Life	H	H	H	H	H	H	H	
3	4	2	1	Power Rating	L	L	L	L	L	L	L	
2	3	5	4	Relative Price								
Element technologies are ranked 1 to 5; 1 is best				Characteristic importance factors: L=Low, M=Moderate, H=High								

Table 2 lists the important performance characteristics of precision potentiometers with an element technology guide along with typical applications that will be encountered.

Table 2: Performance Characteristics of Precision Potentiometers

Panel Control Potentiometers										
Element Technology			Characteristics	Typical Applications						
Cermet	Conductive Plastic	Hybitron®		Balance Control	Triac Control	RC Freq Control (Uncalibrated)	Universal Motor Speed Control	Trace Position	CRT Focus	Amplifier Gain
2	3	2	Resistance Range	H	M	M	L	M	H	L
2	5	3	Resistance Tolerance	L	L	M	L	M	L	L
2	5	3	Temperature Coefficient	L	L	M	L	L	L	L
2	5	4	Power Dissipation	L	M	L	H	M	L	L
4	3	2	Noise/CRV	H	L	H	L	H	L	H
1	1	1	Resolution	L	L	H	L	H	H	M
3	4	1	Adjustability	M	L	H	L	H	M	M
1	5	3	Moisture Stability	L	L	M	L	M	M	M
3	2	3	Linearity	M	L	M	L	M	L	M
3	4	1	Rotational Life	H	H	H	H	H	M	H
1	3	1	Power Rating	L	H	L	M	L	H	L
2	1	3	Relative Price							
Element technologies are ranked 1 to 5; 1 is best			Characteristic importance factors: L=Low, M=Moderate, H=High							

Table 3 lists the important performance characteristics of panel control potentiometers with an element technology guide along with typical applications that will be encountered.

Table 3: Performance Characteristics of Panel Control Potentiometers

Application Notes

Potentiometers

Typical Applications and Circuit Configurations

The following section will familiarize you with the two basic ways in which a potentiometer is applied in a circuit: voltage divider mode and rheostat mode.

Voltage Divider Mode

A resistive voltage divider provides an output voltage in reduced proportion to the voltage applied to its input. In its simplest form, it consists of two resistances in series. The input voltage is applied across the total circuit and the output voltage is developed across one of the individual resistances. A potentiometer can act as a variable voltage divider with the resistive element substituted for the two resistances. The wiper provides an adjustable output voltage. The basic variable voltage divider circuit is shown in Figure 4. An input voltage is applied across the entire resistive element. The output voltage is developed across the lower portion of the element between the wiper and one end of the resistive element.

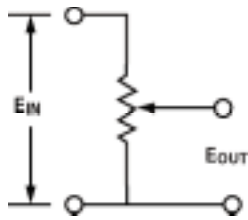

Figure 4: Voltage Divider Circuit

Rheostat Mode

Many applications use the variable resistance between the wiper and one end terminal as a method of current adjustment. This two terminal method of connection is frequently referred to as the rheostat mode. Figure 5 illustrates the basic rheostat circuit. The choice of input and output terminals is arbitrary since the potentiometer, when applied as a current control, is a two-terminal device.

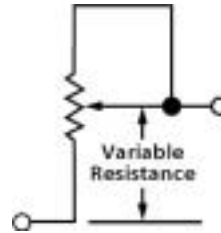

Figure 5: Rheostat Circuit

CAUTION: CONDUCTIVE PLASTIC AND HYBRITRON® ELEMENTS SHOULD BE APPLIED IN VOLTAGE DIVIDER CIRCUITS ONLY.

Some typical applications for precision potentiometers are listed below along with circuit configurations and application details.

Closed-Loop Servo

As a remote shaft position control, the operator moves the panel control to calibrated setting for desired shaft position. The servo potentiometer moves with the panel control shaft to the new balance setting. The input may also be some other signal or sensing device. The motion may be rotary or translatory. Examples are servo-driven meter replacing sensitive D'Arsonval movement, X-Y plotter drives, control surfaces, etc. See Figure 6.

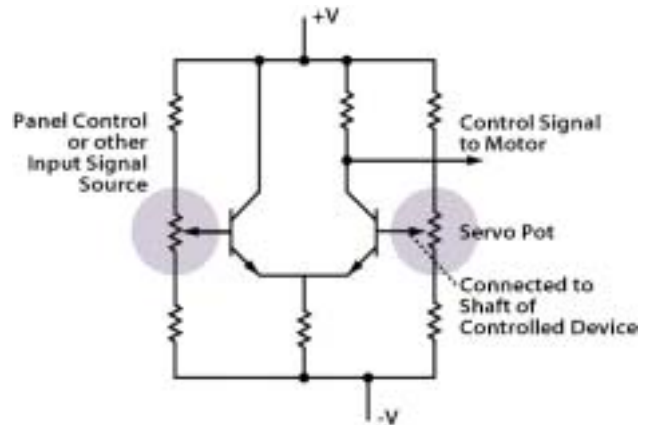

Figure 6: Closed-Loop Servo Circuit

Application Notes

Multiple-Input Position Sensor

In this application, a multiple-input circuit takes outputs from two or more position-indicating potentiometers, resulting in a control voltage output proportional to the sum of the shaft positions. The selected series resistor value must be large compared to potentiometer value for maximum accuracy. Different resistors give weighted sums while opposite polarities give differences. See Figure 7.

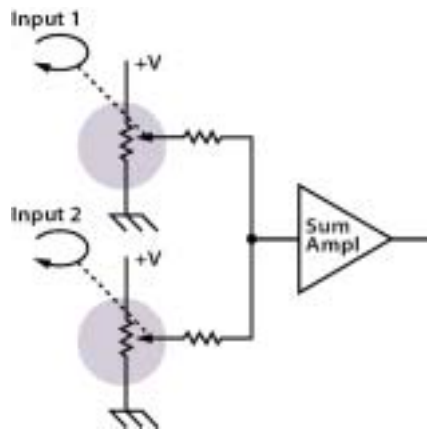

Figure 7: Multiple-Input Position Sensor Circuit

Shaft Angle Sensor

As a shaft angle sensor, the shaft position or direction indicator for rotatable antenna, control surface, valve, tool, etc. The position signal may be indicated, displayed or used to control some related function. See Figure 8.

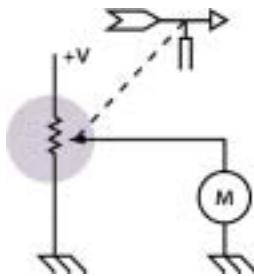

Figure 8: Shaft Angle Sensor Circuit

Regulated Power Supply Voltage Control

A regulated power supply control uses a highly linear 10-turn precision potentiometer. A digital turns-counting dial can be used to indicate the output voltage. See Figure 9.

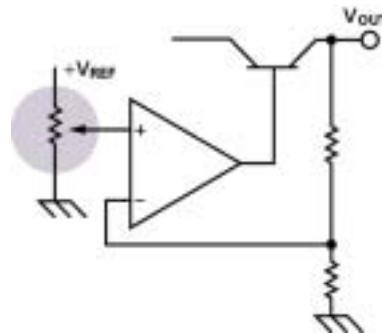

Figure 9: Regulated PS Voltage Control Circuit

RC Frequency Control (Calibrated)

A frequency control in a bridge oscillator requires that the two potentiometers track each other closely. Good linearity is necessary if a calibrated dial is to be used. Wirewound potentiometers work well for frequencies up to a few tens of kHz. At higher frequencies, winding inductance causes problems dictating use of film elements. The resolution of wirewound potentiometers should be considered at the low R (high frequency) end of rotation. Both potentiometers are controlled with a single shaft. See Figure 10.

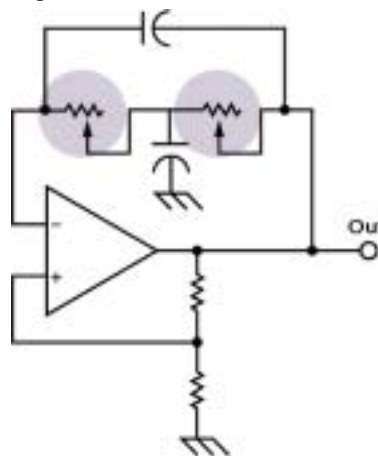

Figure 10: RC Frequency Control Circuit

Application Notes

RCL Bridge Null Control

In this application, the precision potentiometer is used as a dissipation factor dial in a capacitance bridge, and is used in conjunction with a calibrated dial. This application requires the use of a closely controlled output function characteristic found in the precision potentiometer. See Figure 11.

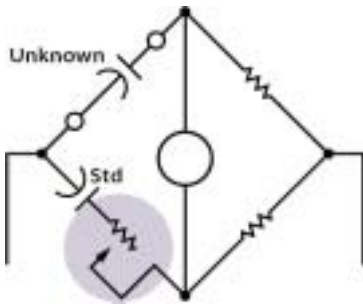

Figure 11: RCL Bridge Null Control Circuit

Sweep Delay Control

When used as a sweep delay control in an oscilloscope or other types of test instrumentation, the 10-turn precision potentiometer requires precise linearity so that the turns-counting dial reading can be accurately converted to a time interval. See Figure 12.

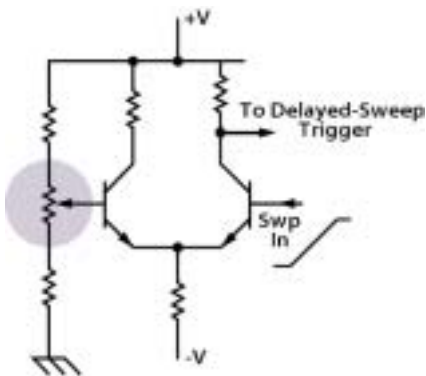

Figure 12: Sweep Delay Control Circuit

Some typical applications for panel control potentiometers are listed below along with circuit configurations and application details.

Audio Frequency Balance Control

A stereo balance control usually requires a pair of non-linear panel control elements with opposite tapers (log and reverse log), or special elements in which no resistance change takes place over half rotation. The panel control is normally a dual cup unit controlled by a single shaft. See Figure 13.

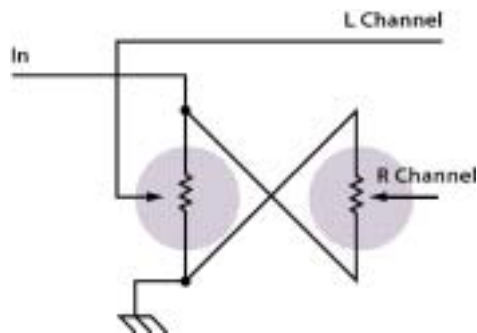

Figure 13: AF Balance Control Circuit

Triac Control

In this application, the panel control is used as a triac load control (i.e., light dimmer) using a rheostat configuration. The principal concern in this application is wiper current or power dissipation and voltage rating. See Figure 14.

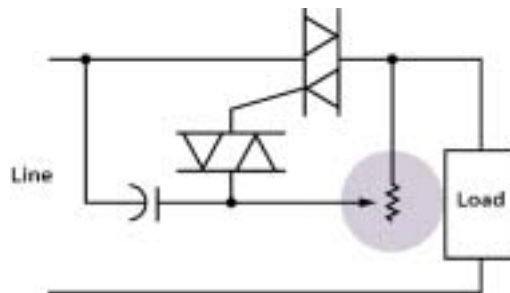

Figure 14: Triac Control Circuit

Application Notes

RC Frequency Control (Uncalibrated)

A panel control can be used as a frequency selector in a square-wave generator. In this application, the panel control is configured as a rheostat with wiper current highest at high frequencies (low R). See Figure 15.

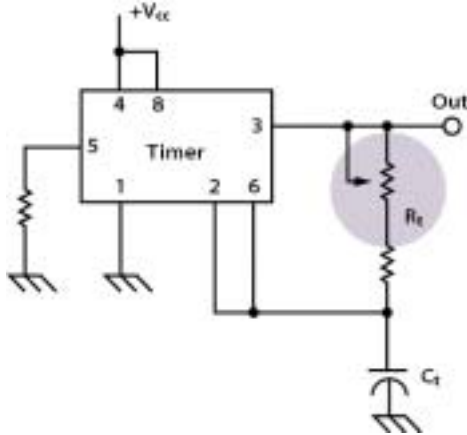

Figure 15: RC Frequency Control Circuit

Universal Motor Speed Control

In this application, the panel control is normally a wirewound in a rheostat configuration capable of substantial wiper current and power dissipation. For higher power motors, the potentiometer is augmented by an SCR. Variable rate of speed change can be accomplished by non-linear potentiometers. Bi-directional speed controls can be accomplished by the addition of a switch. See Figure 16.

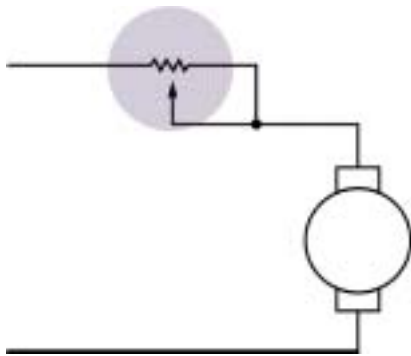

Figure 16: Motor Speed Control Circuit

Trace Position

Used in vertical position control or trace position control for oscilloscope amplifiers, the panel control wiper current is nil in the center, but increases toward each end. Unless limited by specification, CRV may impair adjustability near the ends of rotation. Both panel controls are normally controlled with a single shaft. See Figure 17.

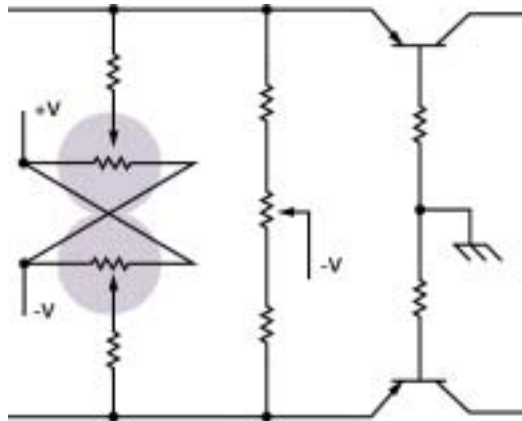

Figure 17: Trace Position Circuit

CRT Focus

In this application, the panel control is used as a focus control for a cathode ray tube (CRT). With no DC load present, there is also no wiper current. Attention must be given to the high voltage rating of the control as it may have several hundred volts across the element and operate at several thousand volts from ground. See Figure 18.

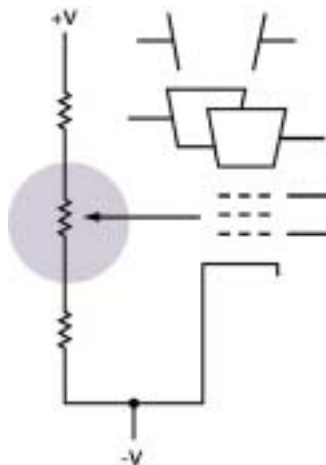

Figure 18: CRT Focus Circuit

Application Notes

Amplifier Gain

A panel control can be used as a gain control in an op-amp circuit. The gain is determined by the resistance ratio $A = R_{FB} / R_{IN}$. See Figure 19.

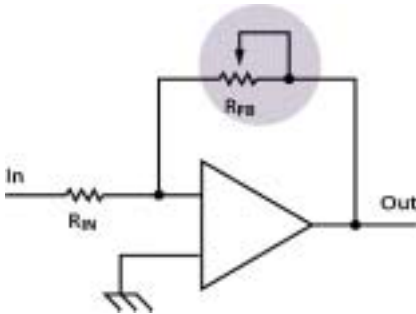

Figure 19: Amplifier Gain Circuit

Encoders

Performance Characteristics

Operating Temperature

Operating temperature refers to the temperature range at which the encoder can be dynamically operated while remaining within specifications. Contacting encoders typically have a much wider operating temperature range than optical encoders.

Contact Resistance

Contact resistance refers to the resistance between contacting mechanical parts used to create the digital output signal. Low contact resistance is desirable in most applications. Encoders constructed from non-contacting technology do not have contact resistance.

Resolution

Resolution refers to the number of electrical pulses per shaft revolution that an encoder produces as a digital output signal. Incremental and absolute contacting encoders are generally limited to low resolutions depending on the materials used in their construction. Optical encoders have a much higher resolution in comparable package sizes.

Encoders							
Encoder Technology		Characteristics	Typical Applications				
Contacting (Mechanical)	Non-Contacting (Optical)		Automotive	Medical Instrumentation	Test & Measurement	Professional Audio	Factory Automation
2	1	Operating Temperature	H	M	H	L	M
2	1	Storage Temperature	H	M	H	L	M
2	1	Operating Speed (RPM)	M	M	H	M	H
2	1	Contact Resistance	M	H	H	M	M
2	1	Resolution (PPR)	M	H	M	M	M
1	2	Moisture Stability	H	H	H	L	H
2	1	Rotational Life	H	H	M	H	H
1	2	Relative Price	Characteristic Importance factors: L=Low, M=Moderate, H=High				
Element technologies are ranked 1 to 2; 1 is best							

Table 4 lists the important performance characteristics of encoders with a technology guide along with typical applications that will be encountered.

Table 4: Performance Characteristics of Encoders

Application Notes

Encoders

General Application Information

Some general application information that should be considered by designers:

- *Encoders should be operated within the recommended operating conditions. Electrostatic discharge (ESD) precautions should be observed at all times with non-contacting type encoders due to possible damage to the internal electronics.*
- *Care should be taken to provide adequate current at the proper voltage to the encoder.*
- *Line drivers should be used when connecting to long leads, low-impedance loads, or capacitive loads. Long leads on the output have an associated capacitance, which can degrade high-frequency signals.*
- *Care should be exercised when attaching the encoder to a heat-generating device, such as a motor, to prevent damage to the encoder. The maximum temperature of the heat-generating surface or the free ambient airspace, whichever is greater, should be considered for selection of a suitable encoder with adequate operating temperature range.*
- *Exceeding the maximum mechanical speed of the encoder may cause permanent damage to the encoder. Exceeding the maximum electrical speed may result in incorrect data or signal error.*
- *Noise in the input power supply or the outputs of an encoder may cause application problems. Some of the common means of minimizing such noise are grounding, twisted pairs, shielded or isolated leads, and signal conditioning.*

Signal Conditioning

Most applications where rotary contacting encoders are used require the use of filters to condition the digital output signal. Commercially available integrated circuits (IC) or programmable logic chips (PLC) provide the proper debounce and noise filtration. Another alternative for signal conditioning is software programming.

The use of debounce filters is recommended with all contacting encoder models to avoid miscounts that may be caused by wiper bounce. Our optical encoder does not require the use of debounce filters due to signal conditioning already provided by the custom designed application specific integrated circuit (ASIC) used in construction of the device.

Debounce filters such as the MC14490 Hex Contact Bounce Eliminator manufactured by ON Semiconductor can be used to eliminate encoder contact bounce. The diagram in Figure 20 shows a typical circuit configuration for encoder debounce filtering. For additional information and specification sheet for this device, visit ON Semiconductor's website at <http://www.onsemi.com>. *Note: This device was formerly manufactured by Motorola.*

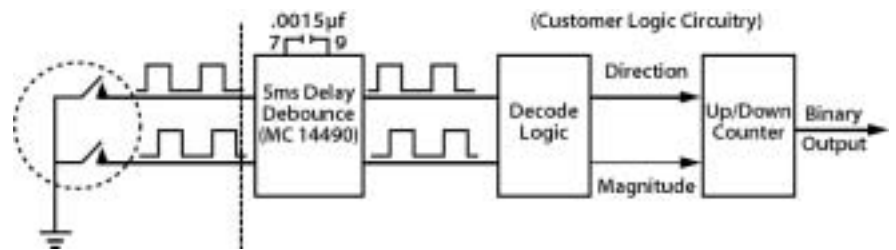

Figure 20: Typical Debounce Circuit Configuration

Application Notes

Incremental encoders can also be used to drive standard up/down counters. In such cases, we suggest using interface ICs similar to the LS7083 and LS7084 Encoder to Counter Interface Chips manufactured by US Digital. The diagram in Figure 21 shows a typical circuit configuration for an encoder applied to drive an up/down counter. For additional information and specification sheet for these devices, visit US Digital's website at <http://www.usdigital.com>.

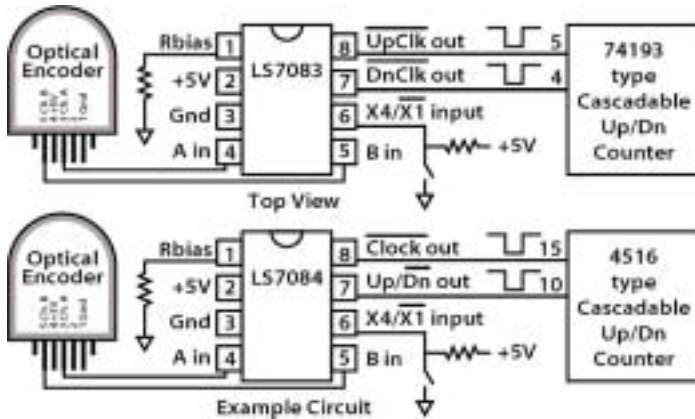
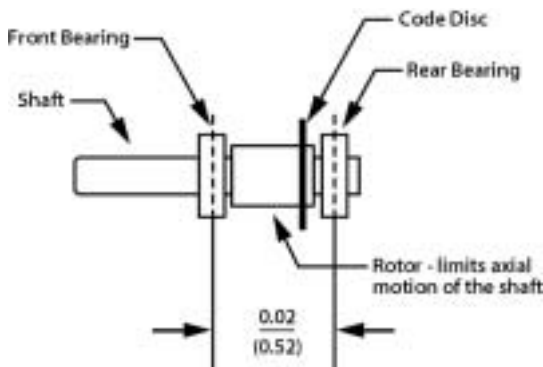

Figure 21: Up/Down Counter Driver Circuit

ENS Style Encoders				
Radial Load (lb)	Axial Load Push	(lb) Pull	L_{10} Life (Hrs) 100 RPM	3,000 RPM
1.0	1	0	8.3×10^6	1.7×10^5
0.5	0	1	8.3×10^6	1.7×10^5
3.0	3	0	5.5×10^5	1.1×10^4
1.5	0	3	5.5×10^5	1.1×10^4
2.5	0	0	1.2×10^6	2.9×10^3
5.0	0	0	1.4×10^5	2.9×10^3
10.0	0	5	2.4×10^4	4.8×10^2

Notes:

- 1) Radial loads are assumed to be applied 1/2" from the front mounting surface (FMS)
- 2) The static load rating (C_0) is 10.7 lbs. for ENT and ENW styles (1/8" shaft dia.) and 21 lbs. for ENS versions (1/4" shaft dia.).
- 3) If R=radial load, AP=axial push load and APL=axial pull load, recommended loading limits are as follows:
 $2R + APL < C_0$ and,
 $R + AP < C_0$



Encoders

Application Information for EN Series Optical Encoder

Bourns® optical encoder produces a 2-bit quadrature signal that is suitable for digital systems where both magnitude and direction of adjustment must be provided. Utilizing solid-state electronics to create the output signal, these encoders have no contacts that will wear or create electrical noise. The optical encoder is ideal as a digital panel control or a position-sensing device in applications where long life, reliability, accuracy, and high resolution are critical.

Rotational Speed/Life

Most bushing mount encoders on the market are limited to rotational speeds of 300 rpm and have a rotational life of 10×10^6 revolutions. To increase operating speed and life specifications, ball bearing shaft supports are added. For high speed and/or extended life applications, Bourns offers shaft ball bearings in either bushing or flange mount versions. With ball bearings, the EN series is capable of operating speeds of 3000+ rpm with a rotational life of up to 5×10^8 revolutions.

Shaft Loading

To accurately predict the rotational life of an encoder, the end (axial) and side (radial) loading forces should be understood. The relationship between shaft loading and rotational life for the EN series is expressed in the tables below. Life is shown here in operating hours (of continuous rotation) at the speed indicated.

Note: Life rating estimates are based on metal fatigue failure criteria. Retention of lubricants may be a limiting factor in extended life applications.

ENT and ENW Style Encoders				
Radial Load (lb)	Axial Load Push	(lb) Pull	L_{10} Life (Hrs) 100 RPM	3,000 RPM
1.0	1	0	4.3×10^6	8.5×10^4
0.5	0	1	4.3×10^6	8.5×10^4
3.0	3	0	2.8×10^5	5.6×10^3
1.5	0	3	2.8×10^5	5.6×10^3
2.5	0	0	4.8×10^5	9.6×10^3
5.0	0	0	6.0×10^4	1.2×10^3
10.0	0	5	1.1×10^4	2.2×10^2

Application Notes

Moment of Inertia

To determine the rotational inertia for the EN series encoder, use the appropriate formula from the table.

Encoder Style	Description	Rotational Inertia (g-cm ²)
ENS	Ball bearing 1/4" dia. shaft	$0.64 + 0.0102 \times$ shaft length modifier
ENT	Ball bearing 1/8" dia. shaft	$0.15 + 0.0006 \times$ shaft length modifier
ENW	Ball bearing 1/8" dia. shaft servo (flange) mount	$0.15 + 0.0006 \times$ shaft length modifier
ENA	Sleeve bearing 1/4" dia. shaft	$0.58 + 0.0102 \times$ shaft length modifier
ENC	Sleeve bearing 1/8" dia. shaft	$0.15 + 0.0006 \times$ shaft length modifier

Calculate the shaft length modifier as follows:
Express the desired shaft length (from the mounting surface - FMS) in thirty-seconds of an inch, and then subtract 28 from the numerator. The result is the shaft length modifiers. For example:

A shaft length (FMS) of 5/8" is equivalent to 20/32. The shaft length modifier is then equal to 20 minus 28, or -8.

Shafts

The EN Series encoder uses a precision-machined metal shaft. The advantages of this feature are: 1) dimensional accuracy, 2) shaft strength, and 3) design flexibility. In addition to standard options, shafts can be easily customized to application specific requirements including special end features. It is also possible to orient an end feature (such as a flatted shaft) to correspond with the optional index channel output. When specifying a shaft length, measure the distance from the encoder mounting surface to the desired shaft end. Do not specify from the point where the shaft exits the bushing.

Shaft Torque

Torque is an important parameter sometimes overlooked in the initial design phase. In panel control (manual adjustment) applications, shaft torque must be sufficient to provide the proper "feel" or to insure setting stability. Conversely, in some position feedback and motor driven uses, it is important that torque be minimized.

Models	Standard Torque	Optional Low Torque	Optional Low Torque
ENS, ENT, ENW	0.05 oz.-in. typ.	0.01 oz.-in. <u>min.</u>	(consult factory)
ENA, ENC	0.75 oz.-in. typ.	0.10 oz.-in. <u>min.</u>	10.0 oz.-in. <u>max.</u>

Torque specifications available from Bourns

Shaft Interfacing

A number of different techniques have been developed for transmitting linear or rotary motion to an encoder. When selecting the appropriate method, typical considerations are space, cost, operating speed, side and end loading, accuracy and cycle life. Choosing the optimum solution may require some specification compromises. For example, a shaft coupling device chosen to minimize side loading for long cycle life may not provide the best system accuracy.

Shaft couplers are commercially available flexible couplers and can be the simplest means of directly interfacing the encoder shaft with another shaft in the system. Two important performance considerations for couplers are:

- 1) *the accuracy with which rotary motion is transmitted to the encoder, (i.e., backlash of the coupler) and*
- 2) *the ability to insulate the encoder from side and end loading. Some commonly used flexible couplers are shown below.*

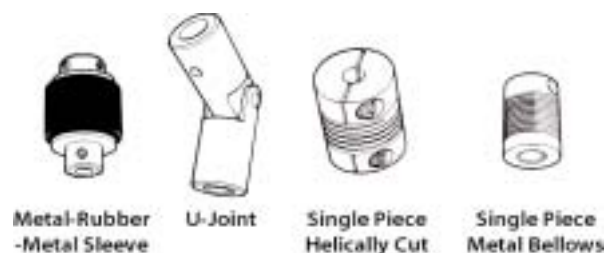

Application Notes

Belt and pulley arrangement can be used to transmit rotary or linear motion to the encoder. Standard timing belts or chains, round belts, wire fishing line, etc., are commonly utilized. A pulley or gear can be mounted directly to the encoder shaft. In some cases it is necessary to reduce heavy side loading created by belt tension. Adding a separate pulley with suitable bearings and connecting the pulley shaft to the encoder with a flexible coupling can accomplish this.

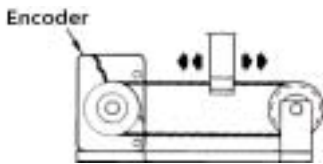

Rack and pinion arrangement can easily transmit linear motion to the encoder. The pinion can be attached directly onto the encoder shaft.

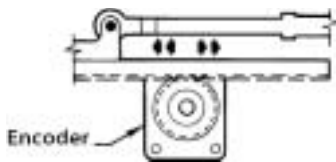

Other methods of interfacing encoder shafts are:

- *Tubing or springs pressed onto the shafts*
- *Interlocking shafts*
- *Rubber wheels*
- *Flatted shafts and receptacles*
- *Gear transmission systems*

When choosing an interfacing technique, remember that the accuracy of the encoder will be no better than the accuracy of the transmission system.

Typical Interface Circuits

The EN Series Optical Encoder may be used as a manual input device for digitally controlled equipment such as CAD/CAM systems, electronic test equipment, medical electronics, instrumentation, computer peripherals and machine tools. Typically, the encoder drives an up/down counter and is used to control one or more functions. Common applications include motor speed control, cursor control, frequency setting, amplifier gain adjustment and table positioning.

This device can also be used for position sensing applications. In this case, a gear can be placed on the encoder shaft allowing it to be interfaced with a moving table, rotating shaft, stepping motor, etc. Movement of the encoder shaft is translated into a 2-bit quadrature signal, which (fed through a logic circuit) allows the microprocessor to determine changes in position. As a position feedback device, there are a wide variety of possible uses for an optical encoder including machine tools, plotters, automated storage systems and robotics.

Application Notes

The logic circuits in Figures 22 and 23 illustrate two techniques for interfacing a quadrature output encoder with a system's microprocessor.

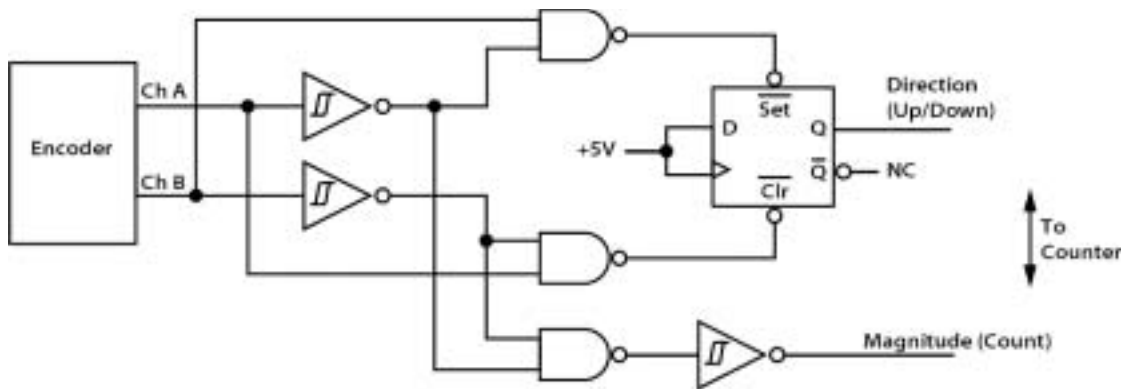

Figure 22: Typical Circuit for Producing Direction (up/down) and Magnitude (count) Signals

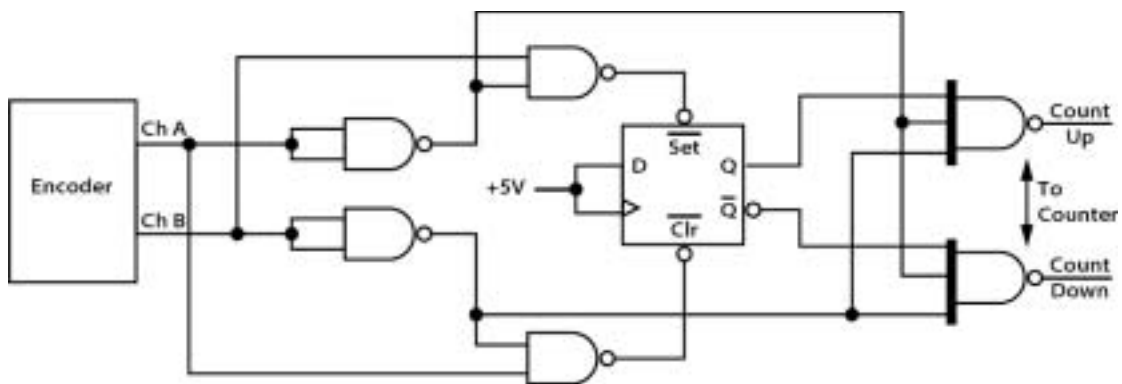

Figure 23: Typical Circuit for Producing Count Up and Count Down Signal

If necessary, rise/fall times can be reduced using the inverters as illustrated in Figure 24.

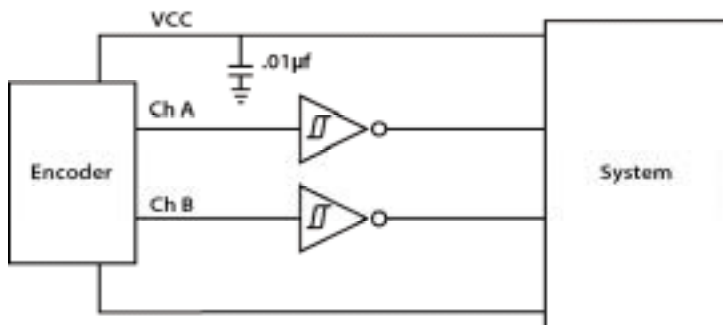

Figure 24: Circuit for Reducing Signal Rise/Fall Times

The typical switch time for the ASIC used in the EN Series is 500 nanoseconds. In applications where high-speed transition times are encountered, voltage spikes may cause a code output error. To eliminate the voltage spikes, we suggest placing a 0.01mf capacitor in the circuit between Vcc and GND.





PRODUCT SELECTION GUIDES





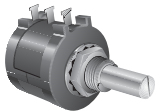
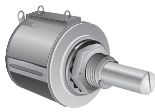
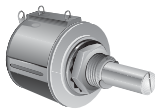

Specifications		3700	3701	3750	3751
Physical	Package Diameter (inch)	1/2	1/2	1/2	1/2
	Shape	Round	Round	Round	Round
	Turns	10	11	12	13
	Sealable	Sealable to IP64	Sealable to IP64	N/A	N/A
Color	Blue	Standard	Standard	Standard	Standard
	Black	Optional	Optional	Optional	Optional
Mounting	Bushing	Standard	Standard	N/A	N/A
	Servo	N/A	N/A	Standard	Standard
	Snap in	N/A	N/A	N/A	N/A
Shaft Material	Metal	Standard	Standard	Standard	Standard
	Plastic	N/A	N/A	N/A	N/A
	Color	Metal	Metal	Metal	Metal
Shaft Dimensions	Standard Diameter in mm	0.24	0.24	0.24	0.24
	Standard Diameter in inches	0.094	0.094	0.094	0.094
	Standard Length in mm	17.45	17.45	9.53	9.53
	Standard Length in inches	0.687	0.687	0.375	0.375
Plastic Shaft	Standard Diameter in mm	N/A	N/A	N/A	N/A
	Standard Diameter in inches	N/A	N/A	N/A	N/A
Shaft Features	Knurl	Optional	Optional	Optional	Optional
	Rear Extension	Optional	Optional	Optional	Optional
	Flatted	Optional	Optional	Optional	Optional
Shaft Torque	Starting & Running	0.6 oz.-in. max.	0.6 oz.-in. max.	0.5 oz.-in. max.	0.5 oz.-in. max.
Bushing	Metal	Standard	Standard	N/A	N/A
	Plastic	N/A	N/A	N/A	N/A
	Split Locking	N/A	N/A	N/A	N/A
Element	Wirewound	Standard	N/A	Standard	N/A
	Hybritron®	N/A	Standard	N/A	Standard
	Cermet	N/A	N/A	N/A	N/A
	TR Tolerances	±5 %	±10 %	±5 %	±10 %
EEA	Maximum	3600 °	3600 °	3600 °	3600 °
	Noise ENR	100 ohms max.	N/A	100 ohms max.	N/A
	Output Smoothness	N/A	0.10 %	N/A	0.10 %
Terminal	PC Pins	Optional	Optional	Optional	Optional
	Solder Lug	Standard	Standard	Standard	Standard
	Rear	N/A	N/A	N/A	N/A
	Side	Standard	Standard	Standard	Standard
	J-Hooks	N/A	N/A	N/A	N/A
Taper	Linear	Standard	Standard	Standard	Standard
	Linearity	±0.25 %	±0.25 %	±0.25 %	±0.25 %
	Repeatability of Dial Readout	N/A	N/A	N/A	N/A

					
Resistance	Min. Resistance (ohms)	100	1 K	100	1 K
	Max. Resistance (ohms)	100 K	100 K	100 K	100 K
Power Rating	Watts	1	1	1	1
Life	Rotational (No Load)	1 M	4 M	1 M	10 M
	Ganging Available	1	1	1	1
Special Options	Ball Bearings	<i>Optional</i>	<i>Optional</i>	<i>Optional</i>	<i>Optional</i>
	Cabling/Connectors	<i>Optional</i>	<i>Optional</i>	<i>Optional</i>	<i>Optional</i>
	Marking	<i>Optional</i>	<i>Optional</i>	<i>Optional</i>	<i>Optional</i>
	A/R Pin	<i>Optional</i>	<i>Optional</i>	N/A	N/A
	Special Linearity	<i>Optional</i>	<i>Optional</i>	<i>Optional</i>	<i>Optional</i>
	Slip Clutch	<i>Optional</i>	<i>Optional</i>	<i>Optional</i>	<i>Optional</i>
	Low Temp Lube	<i>Optional</i>	<i>Optional</i>	<i>Optional</i>	<i>Optional</i>
	Center Tap	<i>Optional</i>	<i>Optional</i>	<i>Optional</i>	<i>Optional</i>
Order Guidelines	Min. Order Quantity	50	50	50	50
	Min. Special Order Quantity	100	100	100	100

 Reliable Electronic Solutions							
Specifications		3590	3540	3541	3543	3545	3500/3501
Physical	Package Diameter (inch)	7/8	7/8	7/8	7/8	7/8	7/8
	Shape	Round	Round	Round	Round	Round	Round
	Turns	10	10	10	3	5	10
	Sealable	Sealable to IP65	Sealable to IP61	Sealable to IP61	Sealable to IP61	Sealable to IP61	Sealable to IP65
Color	Blue	Standard	Standard	Standard	Standard	Standard	Standard
	Black	Optional	Optional	Optional	Optional	Optional	Optional
Mounting	Bushing	Standard	Standard	Standard	Standard	Standard	Standard
	Servo	Optional	Optional	Optional	Optional	Optional	Optional
	Snap in	N/A	N/A	N/A	N/A	N/A	N/A
Shaft Material	Metal	Standard	Standard	Standard	Standard	Standard	Standard
	Plastic	Standard	N/A	N/A	N/A	N/A	N/A
	Color	Metal/Blue	Metal	Metal	Metal	Metal	Metal
Shaft Dimensions	Standard Diameter in mm	6	6.34	6.34	6.34	6.34	6.34
	Standard Diameter in inches	0.249	0.249	0.249	0.249	0.249	0.249
	Standard Length in mm	20.62	20.62	20.62	20.62	20.62	20.62
	Standard Length in inches	0.812	0.812	0.812	0.812	0.812	0.812
Plastic Shaft	Standard Diameter in mm	6	N/A	N/A	N/A	N/A	N/A
	Standard Diameter in inches	0.248	N/A	N/A	N/A	N/A	N/A
Shaft Features	Knurl	N/A	Optional	Optional	Optional	Optional	Optional
	Rear Extension	N/A	Optional	Optional	N/A	N/A	N/A
	Flatted	Optional	Optional	Optional	Optional	Optional	Optional
Shaft Torque	Starting & Running	0.5 oz.-in. max.	0.6 oz.-in. max.	0.6 oz.-in. max.	0.5 oz.-in. max.	0.5 oz.-in. max.	0.6 oz.-in. max.
Bushing	Metal	Standard	Standard	Standard	Standard	Standard	Standard
	Plastic	Standard	N/A	N/A	N/A	N/A	N/A
	Split Locking	N/A	N/A	N/A	N/A	N/A	Optional
Element	Wirewound	Standard	Standard	N/A	Standard	Standard	Standard
	Hybritron®	N/A	N/A	Standard	Optional	Optional	Standard
	Cermet	N/A	N/A	N/A	N/A	N/A	N/A
	TR Tolerances	±5 %	±5 %	±10 %	±5 %	±5 %	±3 %
EEA	Maximum	3600 °	3600 °	3600 °	1080 °	1800 °	3600 °
	Noise ENR	100 ohms max.	100 ohms max.	N/A	100 ohms max.	100 ohms max.	100 ohms max.
	Output Smoothness	N/A	N/A	0.1 %	N/A	N/A	0.1 %
Terminal	PC Pins	Standard	N/A	N/A	N/A	N/A	N/A
	Solder Lug	Standard	Standard	Standard	Standard	Standard	Standard
	Rear	N/A	N/A	N/A	N/A	N/A	N/A
	Side	Standard	Standard	Standard	Standard	Standard	Standard
	J-Hooks	N/A	N/A	N/A	N/A	N/A	N/A
Taper	Linear	Standard	Standard	Standard	Standard	Standard	Standard
	Linearity	±0.25 %	±0.25 %	±0.25 %	±0.25 %	±0.25 %	±0.2 %
	Repeatability of Dial Readout	N/A	N/A	N/A	N/A	N/A	N/A

									
Specifications		3590	3540	3541	3543	3545	3500/3501		
Resistance	Min. Resistance (ohms)	200	100	1 K	20	50	50		
	Max. Resistance (ohms)	100 K	100 K	100 K	50 K	100 K	200 K		
Power Rating	Watts	2.0	2	2	1	1.5	2		
Life	Rotational (No Load)	1 M	1 M	5 M	300 K	500 K	2 M		
Special Options	Multi-section	0	2	2	2	2	2		
	Ball Bearings	N/A	N/A	N/A	N/A	N/A	<i>Optional</i>		
	Cabling/Connectors	<i>Optional</i>	<i>Optional</i>	<i>Optional</i>	<i>Optional</i>	<i>Optional</i>	<i>Optional</i>	<i>Optional</i>	
	Marking	<i>Optional</i>	<i>Optional</i>	<i>Optional</i>	<i>Optional</i>	<i>Optional</i>	<i>Optional</i>	<i>Optional</i>	
	A/R Pin	<i>Standard</i>	<i>Optional</i>	<i>Optional</i>	<i>Optional</i>	<i>Optional</i>	<i>Optional</i>	<i>Optional</i>	
	Special Linearity	<i>Optional</i>	<i>Optional</i>	<i>Optional</i>	<i>Optional</i>	<i>Optional</i>	<i>Optional</i>	<i>Optional</i>	
	Slip Clutch	N/A	<i>Optional</i>	<i>Optional</i>	<i>Optional</i>	<i>Optional</i>	<i>Optional</i>	<i>Optional</i>	
	Low Temp Lube	<i>Optional</i>	<i>Optional</i>	<i>Optional</i>	<i>Optional</i>	<i>Optional</i>	<i>Optional</i>	<i>Optional</i>	
	Center Tap	<i>Optional</i>	<i>Optional</i>	<i>Optional</i>	<i>Optional</i>	<i>Optional</i>	<i>Optional</i>		
Order Guidelines	Min. Order Quantity	50	25	50	50	50	50		
	Min. Special Order Quantity	500	500	500	500	500	500		

					
Specifications		3400	3600	3610	3680
Physical	Package Diameter (inch)	1-13/16	3/4	7/8	N/A
	Shape	Round	Round	Round	Square
	Turns	10	10	10	N/A
	Sealable	Sealable to IP65	N/A	N/A	N/A
Color	Blue	<i>Standard</i>	N/A	N/A	N/A
	Black	N/A	<i>Standard</i>	<i>Standard</i>	<i>Standard</i>
Mounting	Bushing	<i>Standard</i>	<i>Standard</i>	N/A	N/A
	Servo	<i>Optional</i>	N/A	N/A	N/A
	Snap in	N/A	N/A	<i>Standard</i>	<i>Standard</i>
Shaft Material	Metal	<i>Standard</i>	Clock Face	Digital Face	Push Button
	Plastic	N/A	N/A	N/A	N/A
	Color	Metal	N/A	N/A	N/A
Shaft Dimensions	Standard Diameter in mm	6.34	N/A	N/A	N/A
	Standard Diameter in inches	0.249	N/A	N/A	N/A
	Standard Length in mm	20.62	N/A	N/A	N/A
	Standard Length in inches	0.812	N/A	N/A	N/A
Plastic Shaft	Standard Diameter in mm	N/A	N/A	N/A	N/A
	Standard Diameter in inches	N/A	N/A	N/A	N/A
Shaft Features	Knurl	<i>Optional</i>	N/A	N/A	N/A
	Rear Extension	N/A	N/A	N/A	N/A
	Flatted	<i>Optional</i>	N/A	N/A	N/A
Shaft Torque	Starting & Running	2.0 oz.-in. max.	4.0 oz.-in.	4.0 oz.-in.	N/A
Bushing	Metal	<i>Standard</i>	Clock Face	Digital Face	Push Button
	Plastic	N/A	N/A	N/A	N/A
	Split Locking	N/A	N/A	N/A	N/A
Element	Wirewound	<i>Standard</i>	<i>Standard</i>	<i>Standard</i>	N/A
	Hybritron®	N/A	N/A	N/A	N/A
	Cermet	N/A	N/A	N/A	<i>Standard</i>
	TR Tolerances	±3 %	±5 %	±5 %	±3 %
EEA	Maximum	3600 °	3600 °	3600 °	N/A
	Noise ENR	100 ohms max.	100 ohms max.	100 ohms max.	N/A
	Output Smoothness	N/A	N/A	N/A	0.1 %
Terminal	PC Pins	N/A	N/A	N/A	N/A
	Solder Lug	<i>Standard</i>	N/A	N/A	<i>Standard</i>
	Rear	N/A	<i>Standard</i>	<i>Standard</i>	<i>Standard</i>
	Side	<i>Standard</i>	N/A	N/A	N/A
	J-Hooks	N/A	<i>Standard</i>	<i>Standard</i>	N/A
Taper	Linear	<i>Standard</i>	<i>Standard</i>	<i>Standard</i>	<i>Standard</i>
	Linearity	±0.15 %	±0.5 %	±0.5 %	±1 %
	Repeatability of Dial Readout	N/A	.1 % VR	±5 % VR	N/A

					
Specifications		3400	3600	3610	3680
Resistance	Min. Resistance (ohms)	100	100	100	50
	Max. Resistance (ohms)	500 K	100 K	100 K	1 M
Power Rating	Watts	5	1.5	1.5	2
Life	Rotational (No Load)	2 M	200 K	50 K	75 K
Special Options	Multi-section	2	0	0	5
	Ball Bearings	<i>Optional</i>	N/A	N/A	N/A
	Cabling/Connectors	<i>Optional</i>	<i>Optional</i>	<i>Optional</i>	<i>Optional</i>
	Marking	<i>Optional</i>	<i>Optional</i>	<i>Optional</i>	<i>Optional</i>
	A/R Pin	N/A	<i>Standard</i>	N/A	N/A
	Special Linearity	<i>Optional</i>	N/A	N/A	N/A
	Slip Clutch	<i>Optional</i>	N/A	N/A	N/A
	Low Temp Lube	<i>Optional</i>	<i>Optional</i>	<i>Optional</i>	N/A
	Center Tap	<i>Optional</i>	N/A	N/A	N/A
Order Guidelines	Min. Order Quantity	25	50	50	50
	Min. Special Order Quantity	500	500	500	500

 Reliable Electronic Solutions						
Specifications		3435	6534	6537	6538	6539
Physical	Package Diameter (inch)	1-1/16	7/8	7/8	7/8 BB	7/8
	Shape	Round	Round	Round	Round	Round
	Turns	1	1	1	1	1
	Sealable	N/A	Sealable to IP61	Sealable to IP61	Sealable to IP61	Sealable to IP61
Color	Blue	Standard	N/A	N/A	N/A	N/A
	Black	N/A	N/A	N/A	N/A	N/A
	Aluminum	Standard	Standard	Standard	Standard	Standard
Mounting	Bushing	Standard	N/A	N/A	N/A	N/A
	Servo	N/A	Standard	Standard	Standard	Standard
Shaft	Metal	Standard	Standard	Standard	Standard	Standard
	Plastic	N/A	N/A	N/A	N/A	N/A
	Color	Metal	Metal	Metal	Metal	Metal
	Standard Diameter in mm	3.17	3.17	3.17	3.17	3.17
	Standard Diameter in inches	0.125	0.125	0.125	0.125	0.125
	Standard Length in mm	22.23	12.7	12.7	12.7	9.53
	Standard Length in inches	0.875	0.5	0.5	0.5	0.375
	Flatted	Optional	Optional	Optional	Optional	Optional
O-ring Shaft Seal	Optional	N/A	N/A	N/A	N/A	
Shaft Torque	Starting & Running	0.2 oz.-in.	0.25 oz.-in.	0.5 oz.-in.	0.5 oz.-in.	0.5 oz.-in.
Bushing	Metal	Standard	N/A	N/A	N/A	N/A
	Modifications	Optional	Optional	Optional	Optional	Optional
	Double Flatted	Optional	N/A	N/A	N/A	N/A
	Shorter	Optional	N/A	N/A	N/A	N/A
Element	Conductive Plastic	N/A	Standard	Standard	Standard	Standard
	Wirewound	Standard	N/A	N/A	N/A	N/A
	Total Resistance Tolerances	±3 %	±10 %	±10 %	±10 %	±15 %
	Effective Electrical Angle	350 °	320 °	340 °	340 °	340 °
	Output Smoothness (OPS)	N/A	0.1 %	0.1 %	0.1 %	0.1 %
Terminal	PC Pins	N/A	N/A	Optional	Optional	Optional
	Solder Lug	Standard	Standard	Standard	Standard	Standard
	Rear	N/A	N/A	Standard	Standard	Standard
	Side	Standard	Standard	N/A	N/A	N/A
Taper	Linear	Standard	Standard	Standard	Standard	Standard
	Linearity, Standard	0.50 %	0.50 %	±1 %	±1 %	±2 %
	Special Linearity	0.25 %	N/A	0.50 %	0.50 %	0.50 %

 Reliable Electronic Solutions						
Specifications		3435	6534	6537	6538	6539
Resistance	Min. Resistance (ohms)	50	1 K	1 K	1 K	1 K
	Max. Resistance (ohms)	50 K	100 K	100 K	100 K	100 K
Power Rating	Power-Linear (watts)	1.5	1	1	1	1
Life	Rotational (No Load)	2 M	25 M	10 M	20 M	10 M
Special Options	Multiple section	8	4	N/A	N/A	N/A
	Ball Bearings	N/A	<i>Standard</i>	<i>Optional</i>	<i>Standard</i>	<i>Optional</i>
	Front Bearing	<i>Standard</i>	<i>Standard</i>	<i>Optional</i>	<i>Standard</i>	<i>Optional</i>
	Rear Bearing	<i>Standard</i>	<i>Standard</i>	<i>Optional</i>	<i>Standard</i>	<i>Optional</i>
	A/R Pin	N/A	N/A	N/A	N/A	N/A
	Orientation @ Contact Spring	N/A	<i>Optional</i>	<i>Optional</i>	<i>Optional</i>	<i>Optional</i>
	Low Temp Lube -40 °C	<i>Optional</i>	<i>Optional</i>	<i>Optional</i>	<i>Optional</i>	<i>Optional</i>
	Center Tap (Current)	<i>Optional</i>	<i>Optional</i>	<i>Optional</i>	<i>Optional</i>	<i>Optional</i>
	Cable/Connectors	<i>Optional</i>	<i>Optional</i>	<i>Optional</i>	<i>Optional</i>	<i>Optional</i>
	Marking Label	<i>Optional</i>	<i>Optional</i>	<i>Optional</i>	<i>Optional</i>	<i>Optional</i>
	Special EEA	<i>Optional</i>	<i>Optional</i>	<i>Optional</i>	<i>Optional</i>	<i>Optional</i>
Special OPS on Shorter EEA	N/A	<i>Optional</i>	<i>Optional</i>	<i>Optional</i>	<i>Optional</i>	
Order Guidelines	Min. Order Quantity	25	50	50	50	50
	Min. Special Order Quantity	500	500	500	500	500

 Reliable Electronic Solutions							
Specifications		6639	6637	6638	6657	6574	6674
Physical	Package Diameter (inch)	7/8	7/8	7/8	1-5/16	2	2
	Shape	Round	Round	Round	Round	Round	Round
	Turns	1	1	1	1	1	1
	Sealable	Sealable to IP65	Sealable to IP65	Sealable to IP64	Sealable to IP65	Sealable to IP64	Sealable to IP64
Color	Blue	<i>Standard</i>	<i>Standard</i>	N/A	<i>Standard</i>	N/A	N/A
	Black	<i>Optional</i>	<i>Optional</i>	N/A	<i>Optional</i>	N/A	N/A
	Aluminum	N/A	N/A	<i>Standard</i>	N/A	<i>Standard</i>	<i>Standard</i>
Mounting	Bushing	<i>Standard</i>	<i>Standard</i>	<i>Standard</i>	<i>Standard</i>	N/A	<i>Standard</i>
	Servo	N/A	N/A	N/A	N/A	<i>Standard</i>	N/A
Shaft	Metal	<i>Standard</i>	<i>Standard</i>	<i>Standard</i>	<i>Standard</i>	<i>Standard</i>	<i>Standard</i>
	Plastic	<i>Optional</i>	N/A	N/A	<i>Optional</i>	N/A	N/A
	Color	Metal	Metal	Metal	Metal	Metal	N/A
	Standard Diameter in mm	6.34	3.17	3.17	6.34	6.34	6.34
	Standard Diameter in inches	0.249	0.125	0.125	0.249	0.249	0.249
	Standard Length in mm	22.23	22.23	22.23	22.23	15.9	22.23
	Standard Length in inches	0.875	0.875	0.875	0.875	0.625	0.875
	Flatted	<i>Optional</i>	<i>Optional</i>	<i>Optional</i>	<i>Optional</i>	<i>Optional</i>	<i>Optional</i>
O-ring Shaft Seal	<i>Optional</i>	<i>Optional</i>	<i>Optional</i>	<i>Optional</i>	N/A	<i>Optional</i>	
Shaft Torque	Starting & Running	0.5 oz.-in.	0.5 oz.-in.	0.25 oz.-in.	0.5 oz.-in.	0.75 oz.-in.	0.75 oz.-in.
Bushing	Metal	<i>Standard</i>	<i>Standard</i>	<i>Standard</i>	<i>Standard</i>	N/A	<i>Standard</i>
	Modifications	<i>Optional</i>	<i>Optional</i>	<i>Optional</i>	<i>Optional</i>	<i>Optional</i>	<i>Optional</i>
	Double Flatted	<i>Optional</i>	<i>Optional</i>	<i>Optional</i>	<i>Optional</i>	N/A	<i>Optional</i>
	Shorter	<i>Optional</i>	<i>Optional</i>	<i>Optional</i>	<i>Optional</i>	N/A	<i>Optional</i>
Element	Conductive Plastic	<i>Standard</i>	<i>Standard</i>	<i>Standard</i>	<i>Standard</i>	<i>Standard</i>	<i>Standard</i>
	Wirewound	N/A	N/A	N/A	N/A	N/A	N/A
	Total Resistance Tolerances	±15 %	±10 %	±10 %	±10 %	±10 %	±10 %
	Effective Electrical Angle	340 °	340 °	340 °	340 °	350 °	350 °
	Output Smoothness (OPS)	0.1 %	0.1 %	0.1 %	0.1 %	0.1 %	0.1 %
Terminal	PC Pins	<i>Optional</i>	<i>Optional</i>	<i>Optional</i>	<i>Optional</i>	N/A	N/A
	Solder Lug	<i>Standard</i>	<i>Standard</i>	<i>Standard</i>	<i>Standard</i>	<i>Standard</i>	<i>Standard</i>
	Rear	<i>Standard</i>	<i>Standard</i>	<i>Standard</i>	<i>Standard</i>	N/A	N/A
	Side	N/A	N/A	N/A	N/A	<i>Standard</i>	<i>Standard</i>
Taper	Linear	<i>Standard</i>	<i>Standard</i>	<i>Standard</i>	<i>Standard</i>	<i>Standard</i>	<i>Standard</i>
	Linearity, Standard	±2 %	±1 %	±1 %	±1 %	0.25 %	0.25 %
	Special Linearity	0.50 %	0.50 %	0.50 %	0.50 %	N/A	N/A

		Specifications		6639		6637		6638		6657		6574	
Resistance	Min. Resistance (ohms)	1 K		1 K		1 K		1 K		1 K		1 K	
	Max. Resistance (ohms)	100 K		100 K		100 K		100 K		100 K		100 K	
Power Rating	Power-Linear (watts)	1		1		1		1		2		2	
Life	Rotational (No Load)	10 M		10 M		20 M		10 M		25 M		25 M	
Special Options	Multiple section	N/A		N/A		N/A		N/A		4		10	
	Ball Bearings	<i>Optional</i>		<i>Optional</i>		<i>Standard</i>		<i>Optional</i>		<i>Standard</i>		<i>Standard</i>	
	Front Bearing	<i>Optional</i>		<i>Optional</i>		<i>Standard</i>		<i>Optional</i>		<i>Standard</i>		<i>Standard</i>	
	Rear Bearing	<i>Optional</i>		<i>Optional</i>		<i>Standard</i>		<i>Optional</i>		<i>Standard</i>		<i>Standard</i>	
	A/R Pin	<i>Optional</i>		<i>Optional</i>		N/A		<i>Optional</i>		N/A		N/A	
	Orientation @ Contact Spring	<i>Optional</i>		<i>Optional</i>		<i>Optional</i>		<i>Optional</i>		<i>Optional</i>		<i>Optional</i>	
	Low Temp Lube -40 °C	<i>Optional</i>		<i>Optional</i>		<i>Optional</i>		<i>Optional</i>		<i>Optional</i>		<i>Optional</i>	
	Center Tap (Current)	<i>Optional</i>		<i>Optional</i>		<i>Optional</i>		<i>Optional</i>		<i>Optional</i>		<i>Optional</i>	
	Cable/Connectors	<i>Optional</i>		<i>Optional</i>		<i>Optional</i>		<i>Optional</i>		<i>Optional</i>		<i>Optional</i>	
	Marking Label	<i>Optional</i>		<i>Optional</i>		<i>Optional</i>		<i>Optional</i>		<i>Optional</i>		<i>Optional</i>	
	Special EEA	<i>Optional</i>		<i>Optional</i>		<i>Optional</i>		<i>Optional</i>		<i>Optional</i>		<i>Optional</i>	
Special OPS on Shorter EEA	<i>Optional</i>		<i>Optional</i>		<i>Optional</i>		<i>Optional</i>		<i>Optional</i>		<i>Optional</i>		
Order Guidelines	Min. Order Quantity	50		50		50		50		25		25	
	Min. Special Order Quantity	500		500		500		500		500		500	

 Reliable Electronic Solutions				
Specifications		3310	39	3862
Physical	Package Diameter	9 mm	1/2 inch	1/2 inch
	Shape	Square	Round	Round
	Turns	1	1	1
	Sealable	Sealable to IP67	Sealable to IP64	Sealable to IP65
	Detents	N/A	N/A	N/A
Shaft	Metal Shaft	N/A	Standard	Standard
	Plastic Shaft	Standard	N/A	N/A
	Standard Diameter in mm	3.15	4.9	6.0, 4.0
	Standard Diameter in inches	0.125	0.193	0.250, 0.125
	Shaft Color	White	Metal	Metal
Bushing	Metal Bushing	Standard	Standard	Standard
	Plastic Bushing	Standard	N/A	N/A
	No Bushing	Standard	N/A	N/A
	Locking Bushing	N/A	N/A	Standard
	Standard Diameter in mm	6.35	6.0, 4.9	10.0, 7.0
	Standard Diameter in inches	0.250	0.250	0.375, 0.250
Element	Conductive Plastic	Standard	Standard	N/A
	Cermet	N/A	N/A	Standard
	Wirewound	N/A	N/A	N/A
	Hybritron®	N/A	N/A	N/A
Terminal	J-Hooks	N/A	N/A	Standard
	PC Pins	Standard	Standard	Standard
	Solder Lug	N/A	N/A	N/A
	Rear	Standard	Standard	Standard
	Forward Facing	N/A	N/A	N/A
	Side	Standard	N/A	N/A
Taper	Linear Cermet ±10 %	N/A	N/A	Standard
	Linear Cermet ±5 %	N/A	N/A	Optional
	Linear CP ±20 %	Standard	Standard	N/A
	Linear CP ±10 %	N/A	N/A	N/A
	CW Audio Cermet ±10 %	N/A	N/A	N/A
	CCW Audio Cermet ±10 %	N/A	N/A	N/A
	CW Audio CP ±20 %	Optional	Optional	N/A
	CW Audio CP ±10 %	N/A	N/A	N/A
	CCW Audio CP ±20 %	Optional	Optional	N/A
	CCW Audio CP ±10 %	N/A	N/A	N/A
	Linear Wirewound	N/A	N/A	N/A
Independent Linearity	±5 %	±5 %	±5 %	
Resistance	Min. Resistance (ohms)	1 K	5 K	100
	Max. Resistance (ohms)	1 M	100 K	1 M
Power Rating	Power-Linear Cermet (watts)	N/A	N/A	1.0
	Power-Linear CP (watts)	0.25	0.25	N/A
	Power-Audio Cermet (watts)	N/A	N/A	N/A
	Power-Audio CP (watts)	N/A	0.125	N/A
	Wirewound	N/A	N/A	N/A
Life	Rotational (No Load)	50 K	50 K	50 K
Switch	Rotary Switch Available	Standard	Standard	N/A
	Push Momentary Switch	N/A	Standard	N/A

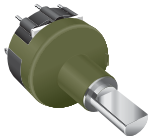
				
Specifications		3310	39	3862
Special Options	Multi-section	2	N/A	N/A
	Anti-rotation lug	Optional	Optional	Standard
	Shaft End Features	Optional	N/A	Optional
	Shaft Flat	Optional	Optional	Optional
	Shaft Length Variations	Optional	Optional	Optional
	Maximum 2 inches (50 mm)	N/A	N/A	N/A
	Dual Concentric Shaft	N/A	N/A	N/A
	Electrical Angle Variations	Optional	Optional	Optional
	Terminal Length Variations	Optional	Optional	Optional
	Surface Mount	N/A	N/A	N/A
	Torque	Optional	Optional	Optional
	Wire Harness	N/A	Optional	Optional
	Connectors	N/A	N/A	Optional
	Extra Hardware	Optional	Optional	Optional
	Mounting Bracket	N/A	N/A	N/A
	Extended Life	N/A	N/A	N/A
	Bushing Styles	Optional	Optional	Optional
	Flatted	N/A	Optional	Optional
	Double Flatted	N/A	Optional	Optional
	Marking	Optional	Optional	Optional
	Servo Mount	N/A	N/A	N/A
Low Temperature (-40 °C)	Optional	Optional	Optional	
Continuous Turn	N/A	N/A	N/A	
Center Detent	N/A	N/A	N/A	
Multiple Detents	N/A	N/A	N/A	
Center Tap	Optional	Optional	Optional	
Order Guidelines	Min. Order Qty - 1 & 2 cup	100	1,000	500
	Min. Order Qty - 3+ cups	N/A	N/A	N/A
	Min. Special Order Quantity	1,000	1,000	1,000



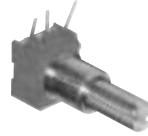
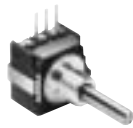



 Reliable Electronic Solutions				
Specifications		51	52	53
Physical	Package Diameter (inch)	1/2	1/2	1/2
	Shape	Square	Square	Square
	Turns	1	1	1
	Sealable	Sealable to IP65	Sealable to IP65	Sealable to IP65
	Detents	<i>Optional</i>	<i>Optional</i>	<i>Optional</i>
Shaft	Metal Shaft	<i>Standard</i>	<i>Standard</i>	<i>Standard</i>
	Plastic Shaft	N/A	N/A	N/A
	Standard Diameter in mm	6.0, 4.0, 3.0	6.0, 4.0, 3.0	6.0, 4.0, 3.0
	Standard Diameter in inches	0.250, 0.125	0.250, 0.125	0.250, 0.125
	Shaft Color	Metal	Metal	Metal
Bushing	Metal Bushing	<i>Standard</i>	<i>Standard</i>	<i>Standard</i>
	Plastic Bushing	N/A	N/A	N/A
	No Bushing	N/A	N/A	N/A
	Locking Bushing	N/A	N/A	N/A
	Standard Diameter in mm	10.0, 7.0, 6.0	10.0, 7.0, 6.0	10.0, 7.0, 6.0
	Standard Diameter in inches	0.375, 0.250	0.375, 0.250	0.375, 0.250
Element	Conductive Plastic	<i>Standard</i>	<i>Standard</i>	<i>Standard</i>
	Cermet	<i>Standard</i>	<i>Standard</i>	<i>Standard</i>
	Wirewound	N/A	N/A	N/A
	Hybritron®	N/A	N/A	N/A
Terminal	J-Hooks	N/A	N/A	N/A
	PC Pins	<i>Standard</i>	<i>Standard</i>	N/A
	Solder Lug	N/A	N/A	<i>Standard</i>
	Rear	<i>Optional</i>	<i>Optional</i>	N/A
	Forward Facing	N/A	N/A	N/A
	Side	<i>Standard</i>	<i>Standard</i>	<i>Standard</i>
Taper	Linear Cermet ±10 %	<i>Standard</i>	<i>Standard</i>	<i>Standard</i>
	Linear Cermet ±5 %	<i>Optional</i>	<i>Optional</i>	<i>Optional</i>
	Linear CP ±20 %	<i>Standard</i>	<i>Standard</i>	<i>Standard</i>
	Linear CP ±10 %	<i>Optional</i>	<i>Optional</i>	<i>Optional</i>
	CW Audio Cermet ±10 %	<i>Optional</i>	<i>Optional</i>	<i>Optional</i>
	CCW Audio Cermet ±10 %	<i>Optional</i>	<i>Optional</i>	<i>Optional</i>
	CW Audio CP ±20 %	<i>Standard</i>	<i>Standard</i>	<i>Standard</i>
	CW Audio CP ±10 %	<i>Optional</i>	<i>Optional</i>	<i>Optional</i>
	CCW Audio CP ±20 %	<i>Optional</i>	<i>Optional</i>	<i>Optional</i>
	CCW Audio CP ±10 %	<i>Optional</i>	<i>Optional</i>	<i>Optional</i>
	Linear Wirewound	N/A	N/A	N/A
Independent Linearity	±10 %	±10 %	±10 %	
Resistance	Min. Resistance (ohms)	150	150	150
	Max. Resistance (ohms)	1 M	1 M	1 M
Power Rating	Power-Linear Cermet (watts)	1.0	1.0	0.5
	Power-Linear CP (watts)	0.5	0.5	0.5
	Power-Audio Cermet (watts)	0.5	0.5	0.5
	Power-Audio CP (watts)	0.25	0.25	0.25
	Wirewound	N/A	N/A	N/A
Life	Rotational (No Load)	25 K or 50 K	25 K or 50 K	25 K or 50 K
Switch	Rotary Switch Available	N/A	N/A	N/A
	Push Momentary Switch	N/A	N/A	N/A

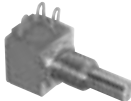

Specifications		51	52	53
Special Options	Multi-section	6	6	6
	Anti-rotation lug	Optional	Optional	Optional
	Shaft End Features	Optional	Optional	Optional
	Shaft Flat	Optional	Optional	Optional
	Shaft Length Variations	Optional	Optional	Optional
	Maximum 2 inches (50 mm)	Optional	Optional	Optional
	Dual Concentric Shaft	Optional	Optional	Optional
	Electrical Angle Variations	Optional	Optional	Optional
	Terminal Length Variations	Optional	Optional	N/A
	Surface Mount	N/A	N/A	N/A
	Torque	Optional	Optional	Optional
	Wire Harness	Optional	Optional	Optional
	Connectors	Optional	Optional	Optional
	Extra Hardware	Optional	Optional	Optional
	Mounting Bracket	Optional	Optional	Optional
	Extended Life	N/A	N/A	N/A
	Bushing Styles	Optional	Optional	Optional
	Flatted	Optional	Optional	Optional
	Double Flatted	Optional	Optional	Optional
	Marking	Optional	Optional	Optional
	Servo Mount	Optional	Optional	Optional
	Low Temperature (-40 °C)	Optional	Optional	Optional
Continuous Turn	N/A	N/A	N/A	
Center Detent	Standard	Standard	Standard	
Multiple Detents	N/A	N/A	N/A	
Center Tap	Optional	Optional	Optional	
Order Guidelines	Min. Order Qty - 1 & 2 cup	500	500	500
	Min. Order Qty - 3+ cups	250	250	250
	Min. Special Order Quantity	1,000	1,000	1,000

Panel Controls Product Selection Guide

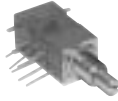





BOURNS®



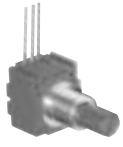

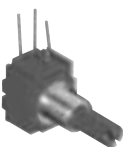

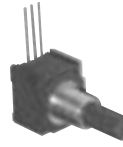
							
Specifications		81	82	83	84	85	86
Physical	Package Diameter (inch)	5/8	5/8	5/8	5/8	5/8	5/8
	Shape	Square	Square	Square	Square	Square	Square
	Turns	1	1	10	10	1	1
	Sealable	Sealable to IP61	Sealable to IP61	Sealable to IP61	Sealable to IP61	Sealable to IP61	Sealable to IP61
	Detents	N/A	N/A	N/A	N/A	N/A	N/A
Shaft	Metal Shaft	Standard	Standard	Standard	Standard	Standard	Standard
	Plastic Shaft	N/A	N/A	N/A	N/A	N/A	N/A
	Standard Diameter in mm	6.0, 4.0	6.0, 4.0	6.0, 4.0	6.0, 4.0	6.0, 4.0	6.0, 4.0
	Standard Diameter in inches	0.250, 0.125	0.250, 0.125	0.250, 0.125	0.250, 0.125	0.250, 0.125	0.250, 0.125
	Shaft Color	Metal	Metal	Metal	Metal	Metal	Metal
Bushing	Metal Bushing	Standard	Standard	Standard	Standard	Standard	Standard
	Plastic Bushing	N/A	N/A	N/A	N/A	N/A	N/A
	No Bushing	N/A	N/A	N/A	N/A	N/A	N/A
	Locking Bushing	Optional	Optional	Optional	Optional	Optional	Optional
	Standard Diameter in mm	10.0, 7.0	10.0, 7.0	10.0, 7.0	10.0, 7.0	10.0, 7.0	10.0, 7.0
Standard Diameter in inches	0.375, 0.250	0.375, 0.250	0.375, 0.250	0.375, 0.250	0.375, 0.250	0.375, 0.250	
Element	Conductive Plastic	Standard	Standard	N/A	N/A	Standard	Standard
	Cermet	Standard	Standard	N/A	N/A	Standard	Standard
	Wirewound	N/A	N/A	Standard	Standard	N/A	N/A
	Hybritron®	N/A	N/A	Standard	Standard	N/A	N/A
Terminal	J-Hooks	N/A	Standard	N/A	N/A	N/A	Standard
	PC Pins	Standard	N/A	Standard	N/A	Standard	N/A
	Solder Lug	N/A	N/A	N/A	Standard	N/A	N/A
	Rear	N/A	N/A	N/A	N/A	N/A	N/A
	Forward Facing	N/A	N/A	N/A	N/A	N/A	N/A
	Side	Standard	Standard	Standard	Standard	Standard	Standard
Taper	Linear Cermet ±10 %	Standard	Standard	N/A	N/A	Standard	Standard
	Linear Cermet ±5 %	Optional	Optional	N/A	N/A	Optional	Optional
	Linear CP ±20 %	Standard	Standard	N/A	N/A	Standard	Standard
	Linear CP ±10 %	Optional	Optional	N/A	N/A	Optional	Optional
	CW Audio Cermet ±10 %	Optional	Optional	N/A	N/A	Optional	Optional
	CCW Audio Cermet ±10 %	Optional	Optional	N/A	N/A	Optional	Optional
	CW Audio CP ±20 %	Standard	Standard	N/A	N/A	Standard	Standard
	CW Audio CP ±10 %	Optional	Optional	N/A	N/A	Optional	Optional
	CCW Audio CP ±20 %	Optional	Optional	N/A	N/A	Optional	Optional
	CCW Audio CP ±10 %	Optional	Optional	N/A	N/A	Optional	Optional
Resistance	Linear Wirewound	N/A	N/A	Standard	Standard	N/A	N/A
	Independent Linearity	±5 %	±5 %	±0.25 %	±0.25 %	±5 %	±5 %
Power Rating	Min. Resistance (ohms)	50	50	200	200	50	50
	Max. Resistance (ohms)	1 M	1 M	100 K	100 K	1 M	1 M
Life	Power-Linear Cermet (watts)	2.0	2.0	N/A	N/A	2.0	2.0
	Power-Linear CP (watts)	1.0	1.0	N/A	N/A	1.0	1.0
	Power-Audio Cermet (watts)	1.0	1.0	N/A	N/A	1.0	1.0
	Power-Audio CP (watts)	0.5	0.5	N/A	N/A	0.5	0.5
	Wirewound	N/A	N/A	1.0	1.0	N/A	N/A
Switch	Rotational (No Load)	100 K	100 K	1 M	4 M	25 K	25 K
	Rotary Switch Available	N/A	N/A	N/A	N/A	Standard	Standard
	Push Momentary Switch	N/A	N/A	N/A	N/A	N/A	N/A

 Reliable Electronic Solutions							
Specifications		81	82	83	84	85	86
Special Options	Multi-section	4	4	3	3	4	4
	Anti-rotation lug	Optional	Optional	Optional	Optional	Optional	Optional
	Shaft End Features	Optional	Optional	Optional	Optional	Optional	Optional
	Shaft Flat	Optional	Optional	Optional	Optional	Optional	Optional
	Shaft Length Variations	Optional	Optional	Optional	Optional	Optional	Optional
	Maximum 2 inches (50 mm)	Optional	Optional	Optional	Optional	Optional	Optional
	Dual Concentric Shaft	Optional	Optional	Optional	Optional	Optional	Optional
	Electrical Angle Variations	Optional	Optional	Optional	Optional	Optional	Optional
	Terminal Length Variations	Optional	N/A	Optional	N/A	Optional	N/A
	Surface Mount	N/A	N/A	N/A	N/A	N/A	N/A
	Torque	Optional	Optional	Optional	Optional	Optional	Optional
	Wire Harness	Optional	Optional	Optional	Optional	Optional	Optional
	Connectors	Optional	Optional	Optional	Optional	Optional	Optional
	Extra Hardware	Optional	Optional	Optional	Optional	Optional	Optional
	Mounting Bracket	N/A	N/A	N/A	N/A	N/A	N/A
	Extended Life	Optional	Optional	N/A	N/A	N/A	N/A
	Bushing Styles	Optional	Optional	Optional	Optional	Optional	Optional
	Flatted	Optional	Optional	Optional	Optional	Optional	Optional
	Double Flatted	Optional	Optional	Optional	Optional	Optional	Optional
	Marking	Optional	Optional	Optional	Optional	Optional	Optional
Servo Mount	Optional	Optional	Optional	Optional	Optional	Optional	
Low Temperature (-40 °C)	Optional	Optional	Optional	Optional	Optional	Optional	
Continuous Turn	Optional	Optional	N/A	N/A	N/A	N/A	
Center Detent	N/A	N/A	N/A	N/A	N/A	N/A	
Multiple Detents	N/A	N/A	N/A	N/A	N/A	N/A	
Center Tap	Optional	Optional	Optional	Optional	Optional	Optional	
Order Guidelines	Min. Order Qty - 1 & 2 cup	500	500	250	250	250	250
	Min. Order Qty - 3+ cups	250	250	100	100	N/A	N/A
	Min. Special Order Quantity	1,000	1,000	500	500	1,000	1,000

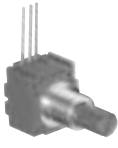
Panel Controls Product Selection Guide

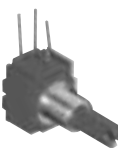
BOURNS®

								
Specifications		91	92	93	94	95	96	99
Physical	Package Diameter (inch)	5/8	5/8	5/8	5/8	5/8	5/8	5/8
	Shape	Square	Square	Square	Square	Square	Square	Square
	Turns	1	1	1	1	1	1	1
	Sealable	Sealable to IP61	Sealable to IP61	Sealable to IP61	Sealable to IP61	Sealable to IP61	Sealable to IP65	Sealable to IP61
	Detents	N/A	N/A	N/A	N/A	N/A	N/A	N/A
Shaft	Metal Shaft	Optional	Optional	Optional	Optional	Optional	Optional	N/A
	Plastic Shaft	Standard	Standard	Standard	Standard	Standard	Standard	Standard
	Standard Diameter in mm	6.0, 4.0	6.0, 4.0	6.0, 4.0	6.0, 4.0	6.0, 4.0	6.0, 4.0	6.0, 4.0
	Standard Diameter in inches	0.250, 0.125	0.250, 0.125	0.250, 0.125	0.250, 0.125	0.250, 0.125	0.250, 0.125	0.250, 0.125
	Shaft Color	Blue	Blue	Blue	Blue	Blue	Blue	Blue
Bushing	Metal Bushing	Standard	Standard	Standard	Standard	Standard	Standard	Standard
	Plastic Bushing	Standard	Standard	Standard	Standard	Standard	Standard	Standard
	No Bushing	N/A	N/A	N/A	N/A	N/A	N/A	N/A
	Locking Bushing	N/A	N/A	N/A	N/A	N/A	N/A	N/A
	Standard Diameter in mm	10.0, 7.0	10.0, 7.0	10.0, 7.0	10.0, 7.0	10.0, 7.0	10.0, 7.0	10.0, 7.0
	Standard Diameter in inches	0.375, 0.250	0.375, 0.250	0.375, 0.250	0.375, 0.250	0.375, 0.250	0.375, 0.250	0.375, 0.250
Element	Conductive Plastic	Standard	Standard	Standard	Standard	Standard	Standard	Standard
	Cermet	Standard	Standard	Standard	Standard	Standard	Standard	Standard
	Wirewound	N/A	N/A	N/A	N/A	N/A	N/A	N/A
	Hybritron®	N/A	N/A	N/A	N/A	N/A	N/A	N/A
Terminal	J-Hooks	N/A	In-Line	N/A	L-Pattern	N/A	N/A	N/A
	PC Pins	In-Line	N/A	L-Pattern	N/A	N/A	In-Line	N/A
	Solder Lug	N/A	N/A	N/A	N/A	Triangle-Pattern	N/A	Triangle Pattern
	Rear	Optional	N/A	N/A	N/A	N/A	Optional	N/A
	Forward Facing	N/A	N/A	N/A	N/A	N/A	N/A	N/A
	Side	Standard	Standard	Standard	Standard	Standard	Standard	Standard
Taper	Linear Cermet ±10 %	Standard	Standard	Standard	Standard	Standard	Standard	Standard
	Linear Cermet ±5 %	Optional	Optional	Optional	Optional	Optional	Optional	Optional
	Linear CP ±20 %	Standard	Standard	Standard	Standard	Standard	Standard	Standard
	Linear CP ±10 %	Optional	Optional	Optional	Optional	Optional	Optional	Optional
	CW Audio Cermet ±10 %	Optional	Optional	Optional	Optional	Optional	Optional	Optional
	CCW Audio Cermet ±10 %	Optional	Optional	Optional	Optional	Optional	Optional	Optional
	CW Audio CP ±20 %	Standard	Standard	Standard	Standard	Standard	Standard	Standard
	CW Audio CP ±10 %	Optional	Optional	Optional	Optional	Optional	Optional	Optional
	CCW Audio CP ±20 %	Optional	Optional	Optional	Optional	Optional	Optional	Optional
	CCW Audio CP ±10 %	Optional	Optional	Optional	Optional	Optional	Optional	Optional
	Linear Wirewound	N/A	N/A	N/A	N/A	N/A	N/A	N/A
Independent Linearity	±5 %	±5 %	±5 %	±5 %	±5 %	±5 %	±5 %	
Resistance	Min. Resistance (ohms)	100	100	100	100	100	100	100
	Max. Resistance (ohms)	1 M	1 M	1 M	1 M	1 M	1 M	1 M
Power Rating	Power-Linear Cermet (watts)	2.0	2.0	2.0	2.0	2.0	2.0	2.0
	Power-Linear CP (watts)	1.0	1.0	1.0	1.0	1.0	1.0	1.0
	Power-Audio Cermet (watts)	1.0	1.0	1.0	1.0	1.0	1.0	1.0
	Power-Audio CP (watts)	0.25	0.25	0.25	0.25	0.25	0.25	0.25
	Wirewound	N/A	N/A	N/A	N/A	N/A	N/A	N/A
Life	Rotational (No Load)	100 K	100 K	100 K	100 K	100 K	100 K	100 K
	Switch							
Switch	Rotary Switch Available	N/A	N/A	N/A	N/A	N/A	N/A	Standard
	Push Momentary Switch	N/A	N/A	N/A	N/A	N/A	N/A	N/A

								
Specifications		91	92	93	94	95	96	99
Special Options	Multi-section	2	2	2	2	2	2	2
	Anti-rotation lug	Optional	Optional	Optional	Optional	Optional	Optional	Optional
	Shaft End Features	Optional	Optional	Optional	Optional	Optional	Optional	Optional
	Shaft Flat	Optional	Optional	Optional	Optional	Optional	Optional	Optional
	Shaft Length Variations	Optional	Optional	Optional	Optional	Optional	Optional	Optional
	Maximum 2 inches (50 mm)	N/A	N/A	N/A	N/A	N/A	N/A	N/A
	Dual Concentric Shaft	N/A	N/A	N/A	N/A	N/A	N/A	N/A
	Electrical Angle Variations	Optional	Optional	Optional	Optional	Optional	Optional	Optional
	Terminal Length Variations	Optional	Optional	Optional	Optional	N/A	Optional	N/A
	Surface Mount	N/A	N/A	N/A	N/A	N/A	N/A	N/A
	Torque	Optional	Optional	Optional	Optional	Optional	Optional	Optional
	Wire Harness	Optional	Optional	Optional	Optional	Optional	Optional	Optional
	Connectors	Optional	Optional	Optional	Optional	Optional	Optional	Optional
	Extra Hardware	Optional	Optional	Optional	Optional	Optional	Optional	Optional
	Mounting Bracket	Optional	Optional	Optional	Optional	Optional	Optional	N/A
	Extended Life	Optional	Optional	Optional	Optional	Optional	Optional	Optional
	Bushing Styles	Optional	Optional	Optional	Optional	Optional	Optional	Optional
	Flatted	Optional	Optional	Optional	Optional	Optional	Optional	Optional
	Double Flatted	Optional	Optional	Optional	Optional	Optional	Optional	Optional
	Marking	Optional	Optional	Optional	Optional	Optional	Optional	Optional
Servo Mount	N/A	N/A	N/A	N/A	N/A	N/A	N/A	
Low Temperature (-40 °C)	Optional	Optional	Optional	Optional	Optional	Optional	Optional	
Continuous Turn	Optional	Optional	Optional	Optional	Optional	Optional	Optional	
Center Detent	N/A	N/A	N/A	N/A	N/A	N/A	N/A	
Multiple Detents	N/A	N/A	N/A	N/A	N/A	N/A	N/A	
Center Tap	Optional	Optional	Optional	Optional	Optional	Optional	Optional	
Order Guidelines	Min. Order Qty - 1 & 2 cup	500	500	500	500	500	500	500
	Min. Order Qty - 3+ cups	N/A	N/A	N/A	N/A	N/A	N/A	N/A
	Min. Special Order Quantity	1,000	1,000	1,000	1,000	1,000	1,000	1,000

 Reliable Electronic Solutions					
Specifications		3851	3852	3856	PC
Physical	Package Diameter (inch)	3/4	3/4	3/4	7/8
	Shape	Round	Round	Round	Square
	Turns	1	1	3-3/4	1
	Sealable	Sealable to IP65	Sealable to IP65	Sealable to IP65	N/A
	Detents	N/A	N/A	N/A	Optional
Shaft	Metal Shaft	Standard	Standard	Standard	N/A
	Plastic Shaft	N/A	N/A	N/A	Standard
	Standard Diameter in mm	6.0, 4.0	6.0, 4.0	6.0, 4.0	N/A
	Standard Diameter in inches	0.250, 0.125	0.250, 0.125	0.250, 0.125	0.250, 0.187
	Shaft Color	Metal	Metal	Metal	Black
Bushing	Metal Bushing	Standard	Standard	Standard	N/A
	Plastic Bushing	N/A	N/A	N/A	Standard
	No Bushing	N/A	N/A	N/A	N/A
	Locking Bushing	Standard	Standard	Standard	N/A
	Standard Diameter in mm	10.0, 7.0	10.0, 7.0	10.0, 7.0	9.0
	Standard Diameter in inches	0.375, 0.250	0.375, 0.250	0.375, 0.250	N/A
Element	Conductive Plastic	Standard	N/A	N/A	Standard
	Cermet	N/A	Standard	Standard	N/A
	Wirewound	N/A	N/A	N/A	N/A
	Hybritron®	N/A	N/A	N/A	N/A
Terminal	J-Hooks	N/A	N/A	N/A	N/A
	PC Pins	Standard	Standard	Standard	Standard
	Solder Lug	Standard	Standard	Standard	Standard
	Rear	Optional	Optional	Optional	Standard
	Forward Facing	Optional	Optional	Optional	Optional
	Side	Standard	Standard	Standard	Standard
Taper	Linear Cermet ±10 %	N/A	Standard	Standard	N/A
	Linear Cermet ±5 %	N/A	Optional	Optional	N/A
	Linear CP ±20 %	N/A	N/A	N/A	Standard
	Linear CP ±10 %	Optional	N/A	N/A	N/A
	CW Audio Cermet ±10 %	N/A	Optional	Optional	N/A
	CCW Audio Cermet ±10 %	N/A	Optional	Optional	N/A
	CW Audio CP ±20 %	Optional	N/A	N/A	Optional
	CW Audio CP ±10 %	Optional	N/A	N/A	N/A
	CCW Audio CP ±20 %	Optional	N/A	N/A	Optional
	CCW Audio CP ±10 %	N/A	N/A	N/A	N/A
	Linear Wirewound	N/A	N/A	N/A	N/A
Independent Linearity	±10 %	±10 %	±10 %	±5 %	
Resistance	Min. Resistance (ohms)	1 K	100	100	500
	Max. Resistance (ohms)	1 M	1 M	1 M	1 M
Power Rating	Power-Linear Cermet (watts)	N/A	2.0	2.0	N/A
	Power-Linear CP (watts)	1.0	N/A	N/A	0.75
	Power-Audio Cermet (watts)	N/A	1.0	1.0	N/A
	Power-Audio CP (watts)	0.5	N/A	N/A	0.25
	Wirewound	N/A	N/A	N/A	N/A
Life	Rotational (No Load)	100 K	50 K	50 K	50 K
Switch	Rotary Switch Available	N/A	N/A	N/A	N/A
	Push Momentary Switch	N/A	N/A	N/A	N/A

 Reliable Electronic Solutions					
Specifications		3851	3852	3856	PC
Special Options	Multi-section	N/A	N/A	N/A	N/A
	Anti-rotation lug	Standard	Standard	Standard	Optional
	Shaft End Features	Optional	Optional	Optional	Optional
	Shaft Flat	Optional	Optional	Optional	Optional
	Shaft Length Variations	Optional	Optional	Optional	Optional
	Maximum 2 inches (50 mm)	Optional	Optional	Optional	N/A
	Dual Concentric Shaft	N/A	N/A	N/A	N/A
	Electrical Angle Variations	Optional	Optional	Optional	Optional
	Terminal Length Variations	Optional	Optional	Optional	Optional
	Surface Mount	N/A	N/A	N/A	N/A
	Torque	Optional	Optional	Optional	Optional
	Wire Harness	Optional	Optional	Optional	Optional
	Connectors	Optional	Optional	Optional	Optional
	Extra Hardware	Optional	Optional	Optional	Optional
	Mounting Bracket	N/A	N/A	N/A	Optional
	Extended Life	N/A	N/A	N/A	Optional
	Bushing Styles	Optional	Optional	Optional	Optional
	Flatted	Optional	Optional	Optional	N/A
	Double Flatted	Optional	Optional	Optional	N/A
	Marking	Optional	Optional	Optional	Optional
	Servo Mount	N/A	N/A	N/A	N/A
	Low Temperature (-40 °C)	Optional	Optional	Optional	Optional
	Continuous Turn	N/A	N/A	N/A	N/A
Center Detent	N/A	N/A	N/A	Standard	
Multiple Detents	N/A	N/A	N/A	Standard	
Center Tap	Optional	Optional	Optional	Optional	
Order Guidelines	Min. Order Qty - 1 & 2 cup	500	500	500	1,000
	Min. Order Qty - 3+ cups	N/A	N/A	N/A	N/A
	Min. Special Order Quantity	1,000	1,000	1,000	1,000

 Reliable Electronic Solutions						
Specifications		PTV09	PTD90/PTR90	PTV111/PTT111	PDB12	PTV142
Physical	Package Diameter (mm)	9	9	12	12	14
	Shape	Square	Square	Square	Round	Square
	Turns	1	1	1	1	1
	Sealable	No	No	No	No	No
	Detents	Center	Center	Center	Center	Center
Shaft	Metal Shaft	N/A	Standard	N/A	N/A	N/A
	Plastic Shaft	Standard	N/A	Standard	Standard	Standard
	Standard Diameter in mm	6.0	6.0	6.0	6.0	6.0
	Shaft Color	Black	Metal	Black	Black	Black
Bushing	Metal Bushing	Optional	Standard	Standard	Optional	Standard
	No Bushing	Standard	N/A	Standard	Standard	Standard
	Locking Bushing	N/A	N/A	N/A	N/A	N/A
	Standard Diameter in mm	N/A	M7x0.75	M9x0.75	N/A	M9x0.75
Element	Carbon	Standard	Standard	Standard	Standard	Standard
Terminal	PC Pins	Standard	Standard	Standard	Standard	Standard
	Rear	Standard	N/A	Standard	Standard	Standard
	Forward Facing	N/A	N/A	N/A	Optional	N/A
	Side	Standard	Optional	Standard	Standard	Standard
Taper	Linear $\pm 20\%$	Standard	Standard	Standard	Standard	Standard
	Audio $\pm 20\%$	Standard	Standard	Standard	Standard	Standard
	Independent Linearity	$\pm 20\%$	$\pm 20\%$	$\pm 20\%$	$\pm 20\%$	$\pm 20\%$
Resistance	Min. Resistance (ohms)	1 K	1 K	1 K	1 K	1 K
	Max. Resistance (ohms)	1 M	1 M	1 M	1 M	1 M
Power Rating	Power-Linear (watts)	0.5	0.5	0.5	0.2	0.5
	Power-Audio (watts)	0.5	0.5	0.5	0.1	0.5
Life	Rotational (No Load)	10 K	10 K	10 K	15 K	15 K
Switch	Rotary Switch Available	N/A	Standard	N/A	N/A	N/A
Special Options	Multi-Section	N/A	8	N/A	2	2
	Shaft End Features	Optional	Optional	Optional	Optional	Optional
	Shaft Flat	Standard	Optional	Standard	Standard	Standard
	Shaft Length	Optional	Optional	Optional	Optional	Optional
	Pin Length	Optional	Optional	Optional	Optional	Optional
	Torque	Optional	Optional	Optional	N/A	Optional
	Extra Hardware	Optional	Optional	Optional	Optional	Optional
	Mounting Bracket	Optional	N/A	Optional	Optional	Optional
	Low Temperature (-40 °C)	Optional	Optional	Optional	Optional	Optional
Center Tap	N/A	N/A	Standard	N/A	N/A	
Order Guidelines	Min. Order Quantity	1,000	1,000	1,000	1,000	1,000
	Min. Special Order Quantity	50,000	50,000	50,000	50,000	50,000

 Reliable Electronic Solutions						
Specifications		PDA17	PDB18	PDV	PTA	PTB
Physical	Package Diameter (mm)	17	12	10-30	15-60	45-100
	Shape	Round	Round	Slide	Slide	Slide
	Turns	1	1	1	1	1
	Sealable	No	No	No	Dust Cover	Dust Cover
	Detents	N/A	Optional	Center	Center	Center
Shaft	Metal Shaft	N/A	Standard	Optional	Optional	Optional
	Plastic Shaft	Standard	N/A	Optional	Optional	Optional
	Standard Diameter in mm	6.0	6.0	6.0	6.0	6.0
	Shaft Color	Black	Metal	White	White	White
Bushing	Metal Bushing	Standard	Standard	N/A	N/A	N/A
	No Bushing	N/A	N/A	Standard	Standard	Standard
	Locking Bushing	N/A	N/A	N/A	N/A	N/A
	Standard Diameter in mm	M7x0.75	M7x0.75	N/A	N/A	N/A
Element	Carbon	Standard	Standard	Standard	Standard	Standard
Terminal	PC Pins	Standard	Standard	Standard	Standard	Standard
	Rear	Standard	Optional	Optional	Optional	Optional
	Forward Facing	Optional	Optional	N/A	N/A	N/A
	Side	Standard	Standard	N/A	N/A	N/A
Taper	Linear $\pm 20\%$	Standard	Standard	Standard	Standard	Standard
	Audio $\pm 20\%$	Standard	Standard	Standard	Standard	Standard
	Independent Linearity	$\pm 20\%$	$\pm 20\%$	$\pm 20\%$	$\pm 20\%$	$\pm 20\%$
Resistance	Min. Resistance (ohms)	1 K	1 K	1 K	1 K	1 K
	Max. Resistance (ohms)	1 M	1 M	1 M	1 M	1 M
Power Rating	Power-Linear (watts)	0.1	0.2	0.1	0.5	0.125
	Power-Audio (watts)	0.05	0.1	0.05	0.025	0.025
Life	Rotational (No Load)	15 K	15 K	10 K	15 K	15 K
Switch	Rotary Switch Available	Standard	N/A	N/A	N/A	N/A
Special Options	Multi-Section	N/A	2	N/A	N/A	N/A
	Shaft End Features	Optional	Optional	Optional	Optional	Optional
	Shaft Flat	Optional	Optional	N/A	N/A	N/A
	Shaft Length	Optional	Optional	N/A	N/A	N/A
	Pin Length	Optional	Optional	Optional	Optional	Optional
	Torque	N/A	Optional	Optional	Optional	Optional
	Extra Hardware	N/A	Optional	Optional	Optional	Optional
	Mounting Bracket	N/A	Optional	N/A	N/A	N/A
	Low Temperature (-40 °C)	Optional	Optional	Optional	Optional	Optional
Center Tap	N/A	N/A	N/A	N/A	N/A	
Order Guidelines	Min. Order Quantity	1,000	1,000	1,000	1,000	1,000
	Min. Special Order Quantity	50,000	50,000	50,000	50,000	50,000

 Reliable Electronic Solutions							
Specifications		3315	ES	EPS	ECW	EAW	EN
Physical	Package (LxW) without Shaft Length	0.375 mm x 0.375 mm	.78 " square	0.874 x 1.061 x 0.496 "	0.874 x 1.122 x 0.585 "	0.940 x 1.10 x 0.596 "	0.835 x 0.625 x 0.73 "
	Sealable	Sealable to IP67	N/A	N/A	N/A	N/A	Sealable to IP65
	Switch Available	N/A	N/A	Standard	N/A	N/A	N/A
	Detents	N/A	12, 24	24	0, 12, 24, 36	30, 36	N/A
Shaft	Material	Plastic	N/A	Plastic	Plastic	Plastic	Stainless Steel
	Standard Diameter in inches	0.125	N/A	N/A	0.250, 0.187	0.250	0.250, 0.125
	Standard Diameter in mm	3.18, 2.39 flatted	N/A	4.8	6.0	6.0	N/A
	Shaft Length (FMS)	5.59 mm; 12.7 mm; 19.05 mm (w/bushing)	N/A	15.2 mm	1/2 " to 1-1/8 " 19, 22 & 24 mm	3/4 "	1/2 " to 7/8 "
Bushing	Material	Plastic; Plated Brass	Plastic	Plastic	Plastic	Plastic	Aluminum; Ni-Plated Brass
	Standard Diameter in inches	0.250	0.375	N/A	N/A	N/A	0.375; 0.250
	Standard Diameter in mm	6.35	9.52	9.0	9.0	9.0	N/A
Terminal	Configuration	3 Pin	3 Pin	5 Pin	3 Pin	10 Pin	5 Pin or Cables with & without connector
Operational Information	Output Type	Incremental 2-bit gray code, quadrature output	Incremental 2-bit gray code, quadrature output	Incremental 2-bit gray code, quadrature output	Incremental 2-bit gray code, quadrature output	Absolute, unique gray code output	Incremental, 2-bit quadrature output, Index channel optional
	Resolution (pulses per rev.)	6, 16 ppr	6, 9, 12, 24 ppr	6, 9, 12, 24, 36 ppr	6, 9, 12, 24, 36 ppr	30, 36, 128 ppr	25, 50, 64, 100, 125, 128, 200, 256 ppr
	Rotational Speed (max.)	120 RPM	120 RPM	120 RPM	120 RPM	120 RPM	200 RPM std. 3000 RPM w/ Ball Bearing
	Oper. Temperature Range	-55 °C to +125 °C	+1 °C to +125 °C	-40 °C to +85 °C	+1 °C to +125 °C	+1 °C to +125 °C	-40 °C to +85 °C
	Rise/Fall Times	N/A	N/A	N/A	N/A	N/A	200 ns
	Contact Bounce (max.)	5 milliseconds	5 milliseconds	5 milliseconds	5 milliseconds	2.7 milliseconds	N/A
	Contact Rating	10 mA @ 10 VDC or 0.1 watt max.	10 mA @ 10 VDC or 0.1 watt max.	10 mA @ 10 VDC or 0.1 watt max.	10 mA @ 10 VDC or 0.1 watt max.	10 mA @ 10 VDC or 0.1 watt max.	26 mA @ 5 VDC or 0.1 watt max.
	Mounting Torque	4.0 lbs.-in. max.	7 lbs.-in. max.	7 lbs.-in. max.	7 lbs.-in. max.	7 lbs.-in. max.	15-18 lbs.-in. max.
Running Torque	5 oz.-in max.	N/A	0.75 to 2.25 oz.-in.	0.75 to 2.25 oz.-in.	0.75 to 2.25 oz.-in.	0.1 to 1.5 oz.-in.	
Life	Rotational Life (shaft revs.)	25,000 @ 16 ppr 100,000 @ 6 ppr	200,000	200,000	200,000	50,000	10 million std. 200 million w/ Ball Bearing
Special Options	Shaft End Features	N/A	N/A	Optional	Optional	Optional	Optional
	Shaft Length 1 in. or longer	N/A	N/A	N/A	N/A	N/A	Optional
	Shaft Flat	Optional	N/A	Optional	Optional	Optional	Optional
	Anti-rotation lug	Optional	N/A	Optional	Optional	Optional	Optional
	Extra Hardware	Optional	N/A	Optional	Optional	Optional	Optional
	Servo Mount	N/A	N/A	N/A	N/A	N/A	Optional
	Ball Bearing version	N/A	N/A	N/A	N/A	N/A	Optional
	Index Channel (up to 128 ppr)	N/A	N/A	N/A	N/A	N/A	Optional
	PC Mounting Bracket	N/A	N/A	N/A	Optional	Optional	Optional
	Pin Length	N/A	N/A	Optional	Optional	Optional	Optional
	Terminal Configuration	Optional	Optional	Optional	Optional	Optional	Optional
	Cabling/Connectors	Optional	Optional	Optional	Optional	Optional	Optional
	Low Temperature	Optional	Optional	Optional	Optional	Optional	Optional
Marking	Optional	Optional	Optional	Optional	Optional	Optional	
Custom Resolution	Optional	Optional	Optional	Optional	Optional	Optional	
Order Guidelines	Min. Order Quantity	100	270	135	135	135	50
	Min. Special Order Quantity	1,000	990	990	990	990	500

 Reliable Electronic Solutions				
Specifications		PEC11	PEC12	PEC16
Physical	Package (LxW in mm) without Shaft Length	12.5 x 13.2 mm	12.4 x 13.2 mm	16 x 12.5 mm
	Sealable	N/A	N/A	N/A
	Switch Available	Standard	Standard	Standard
	Detents	18, 24	12, 24	12, 24
Shaft	Material	Zinc	Plastic	Plastic
	Standard Diameter in inches	N/A	0.250	0.250
	Standard Diameter in mm	6.0	6.0	6.0
	Shaft Length (FMS)	15, 20, 25, 30 mm	15, 20, 25 mm	17.5, 20, 22.5, 25, 30 mm
Bushings	Material	Zinc	N/A	Zinc
	Standard Diameter in inches	N/A	N/A	N/A
	Standard Diameter in mm	M7	N/A	M9
Terminal	Configuration	3, 5 Pin	3, 5 Pin	3, 5 Pin
Operational Information	Output Type	Incremental 2-bit gray code, quadrature output	Incremental 2-bit gray code, quadrature output	Incremental 2-bit gray code, quadrature output
	Resolution (pulses per rev.)	12, 18, 24 ppr	12, 24 ppr	12, 24 ppr
	Rotational Speed (max.)	60 RPM	100 RPM	100 RPM
	Oper. Temperature Range	-30 °C to +70 °C	-10 °C to +70 °C	-10 °C to +70 °C
	Rise/Fall Times	N/A	N/A	N/A
	Contact Bounce (max.)	5 milliseconds	5 milliseconds	5 milliseconds
	Contact Rating	1 mA @ 5 VDC	1 mA @ 5 VDC	1 mA @ 5 VDC
	Running Torque	50 to 200 gf-cm	30.6 to 204 g-cm	30.6 to 204 g-cm
Life	Rotational Life (shaft revs.)	30,000	30,000	100,000
Special Options	Shaft End Features	N/A	N/A	N/A
	Shaft Length 1 in. or longer	N/A	N/A	N/A
	Shaft Flat	Optional	Optional	Optional
	Anti-rotation lug	Optional	Optional	Optional
	Extra Hardware	Optional	Optional	Optional
	Servo Mount	N/A	N/A	N/A
	Ball Bearing version	N/A	N/A	N/A
	Index Channel (up to 128 ppr)	N/A	N/A	N/A
	PC Mounting Bracket	N/A	N/A	N/A
	Pin Length	N/A	N/A	N/A
	Terminal Configuration	Optional	Optional	Optional
	Cabling/Connectors	Optional	Optional	Optional
	Low Temperature	Optional	Optional	Optional
	Marking	N/A	N/A	N/A
Custom Resolution	N/A	N/A	N/A	
Order Guidelines	Min. Order Quantity	1,000	1,000	1,000
	Min. Special Order Quantity	50,000	50,000	50,000

Specifications		H-22	H-23	H-46	H-490
Physical	Turns	0-15	0-15	0-20	0-30
	Readout	Concentric Scale	Concentric Scale	Concentric Scale	Concentric Scale
	Package Diameter (mm)	22	22	46	25.4
	Depth (mm)	24	25	25	23
	Division/Turn	50	50	100	100
	Weight	15 g	15 g	73 g	1/4 oz.
Shaft Dimensions	Part No./Shaft Diameter	H-22-6A: 1/4 " H-22-6M: 6 mm H-22-3A: 1/8 "	H-23-6A: 1/4 " H-23-6M: 6 mm H-23-3A: 1/8 "	H-46-6A: 1/4 " H-46-6M: 6 mm	H-493-2: 1/8 " H-494-2: 1/8 " H-491-3: 1/4 " H-492-3: 1/4 " H-493-3: 1/4 " H-494-3: 1/4 " H-492-2: 1/4 "
	POT/ Dial Selection	Bourns Matching POTS	3540S 3541H 3543S 3545S 3590S	3540S 3541H 3543S 3545S 3590S	3540S 3541H 3543S 3545S 3590S

Specifications		H-506	H-550	CT-23	CT-26
Physical	Turns	0-15	0-11	0-10	0-10
	Readout	Concentric Scale	Concentric Scale	Digital	Digital
	Package Diameter (mm)	22	46	27	28
	Depth (mm)	25	25	31.5	31.5
	Division/Turn	50	100	500	500
	Weight	7 g	13 g	34 g	34 g
Shaft Dimensions	Part No./Shaft Diameter	H-506-1/4: 1/4 " H-506-6M: 6 mm	H-550-6A: 1/4 " H-550-6A-1: 1/4 "	CT-23-6A: 1/4 " CT-23-6M: 6 mm	CT-26-6A: 1/4 " CT-26-6M: 6 mm
	POT/ Dial Selection	Bourns Matching POTS	3540S 3541H 3543S 3545S 3590S	3540S 3541H 3543S 3545S 3590S	3540S 3541H 3543S 3545S 3590S

Panel control mounting hardware is determined by bushing style. The "X" in the bushing style column indicates what hardware is used with the bushing. Hardware indicated by a shaded area is normally supplied with unit. Other hardware may be ordered separately. Hardware may be bulk packaged or individually packaged with units, depending on the model.

Part Number and Description	Bushing Style and Dimension									
	A	B	C	E	F	J	L	U	N	R
	3/8 " dia.	locking, 3/8 " dia.	1/4 " dia.	locking, 1/4 " dia.	1/4 " dia.	3/8 " dia.	9 mm dia.	7 mm dia.	1/4 " dia.	10 mm dia.
H-36-1 Flat Washer			X	X	X				X	
H-36-2 Flat Washer	X	X				X				
H-37-1 Lockwasher			X	X	X				X	
H-37-2 Lockwasher	X	X				X	X			
H-38-1 Mounting Nut			X	X	X				X	
H-38-2 Mounting Nut	X	X				X				
H-38-3 Lock Nut				X						
H-38-4 Lock Nut		X								
H-37-3 Lockwasher								X		
H-37-4 Lockwasher										X
H-37-5 Lockwasher										
H-38-8 M7 Mounting Nut								X		
H-38-9 M10 Mounting Nut										X
H-38-11 M9 Mounting Nut							X			
H-38-14 M6 Mounting Nut										
H-W06-MM Flat Washer & Mounting Nut set (1 each)										
H-W09-MM Flat Washer & Mounting Nut set (1 each)										

Part Number and Description	Bushing Style and Dimension				Model					
	S Model 50	S Model EN	T Model 3862	W	3310/3315	PDA17	PDB18	PTD90	PTV111	PTV142
	6 mm dia.	3/8 " dia.	1/4 " dia.	9 mm dia.	1/4" dia.					
H-36-1 Flat Washer			X							
H-36-2 Flat Washer		X								
H-37-1 Lockwasher	X		X							
H-37-2 Lockwasher		X		X						
H-38-1 Mounting Nut			X		X					
H-38-2 Mounting Nut		X								
H-38-3 Lock Nut			X							
H-38-4 Lock Nut										
H-37-3 Lockwasher										
H-37-4 Lockwasher					X					
H-37-5 Lockwasher					X					
H-38-8 M7 Mounting Nut										
H-38-9 M10 Mounting Nut										
H-38-11 M9 Mounting Nut				X						
H-38-14 M6 Mounting Nut	X									
H-W06-MM Flat Washer & Mounting Nut set (1 each)						X	X	X		
H-W09-MM Flat Washer & Mounting Nut set (1 each)									X	X

Glossary of Terms

Absolute code

Binary code where only 1-bit changes logic state from one angular position to the next (a.k.a. Gray code).

ASIC

Application-specific integrated circuit

Backlash

The maximum difference in shaft position that occurs when the shaft is moved to the same actual output ratio point from opposite directions.

Binary

Two logical states (High, 1, true/Low, 0 false); the basis of binary data-processing systems.

Binary code

A specific code utilizing the binary numbering system (i.e. "0" and "1").

Bit

(incremental encoders) Refers to 1 quantum of data or 1 increment of digital code. (absolute encoders) Refers to the number of tracks which normally equate to 2^{nth} power, i.e., 8 bits = 2⁸ = 256 discrete positions, likewise 12 bits = 2¹² = 4,096 discrete positions.

Carbon

A mixture of carbon powder and phenolic resin that is sprayed, screened, or brushed onto a phenolic or ceramic substrate.

Cermet

A mixture of metal particles, precious metal oxides, glass powders, blended with a liquid vehicle. This material is typically screened onto a substrate (commonly ceramic) and fired at temperatures that flow glass to fabricate resistive elements for potentiometers.

Code

The digital output signal produced by an encoder.

Conductive plastic (CP)

A binder or resin blended with carbon powder and/or other conductive material. This material is screened onto an insulating substrate to fabricate resistive elements for potentiometers.

Contact resistance variation (CRV)

The variation in resistance between the wiper and a non-wirewound resistive element when the wiper is energized with a specified current and moved over the electrical travel in either direction at a specified speed (does not include the effects of roll-on or roll-off).

Cycles per revolution (CPR)

The number of full quadrature cycles per full shaft revolution (360 mechanical degrees).

Cup

A single mechanical section of a potentiometer. A multi-cup potentiometer may contain one or more sections, either electrical resistance elements or switch modules.

Current tap

An electrical connection fixed to the resistance element, which is capable of carrying, rated element current and may distort the output characteristic.

Electrical cycle

One complete four-state quadrature cycle. Each cycle is divided into 360 electrical degrees (°e) and can be decoded into 1, 2, or 4 counts, referred to as X1, X2, or X4 resolution multipliers.

Electrical degree (°e)

1/360 of one full quadrature cycle.

Glossary of Terms

Dielectric withstanding voltage

Ability to withstand under prescribed conditions, a specified potential of a given characteristic between the terminals of each cup and the exposed conducting surfaces of the potentiometer, or between the terminals of each cup and the terminals of every other cup in the potentiometer without exceeding a specified leakage current.

Effective electrical angle (EEA)

The total amount of angular input rotation over which the output ratio actually varies.

Encoder

A device that produces a digital output signal; typically an incremental quadrature, binary, or absolute output signal. This device eliminates the need for analog-to-digital (A/D) signal conversion.

End resistance

The resistance measured between the wiper terminal and end terminal with the shaft positioned at the corresponding end of mechanical travel.

End voltage (non-wirewound)

The voltage between the wiper terminal and an end terminal when the shaft is positioned at the corresponding theoretical end point. End voltage is expressed as a percent of the total applied voltage.

End voltage (wirewound)

The voltage between the wiper terminal and an end terminal when the shaft is positioned at the corresponding end point. End voltage is expressed as a percent of the total applied voltage.

Equivalent noise resistance (ENR)

The variation in resistance between the wiper and a wirewound resistive element that occurs when the wiper is energized with a specified current and moved over the electrical travel in either direction at a specified speed (does not include the effects of roll-on or roll-off).

Gang

An assembly of two or more cups on a common operating shaft.

Gray code

Binary code where only 1-bit changes logic state from one angular position to the next (a.k.a. Absolute code).

Hybritron®

A hybrid element consisting of a wirewound element with a conductive plastic coating; this element will exhibit the stability characteristics of a wirewound element with the long operational life of a conductive plastic element.

Incremental

The repetitive pattern of logic states (High, 1, true/Low, 0 false) in the output signal of an encoder occurring with each successive electrical cycle of resolution.

Index

The output signal of an index channel is normally a single pulse per revolution. This output can be used to indicate a “zero” or “home” position in the shaft rotation. Adding an index channel to an incremental encoder allows the encoder to provide absolute position. (Also referred to as “Index channel” and “Z-channel”)

Independent linearity

The maximum deviation of the actual wiper output function from a straight reference line with its slope and position chosen to minimize deviations.

Interpolation

A multiplication technique used to increase encoder resolution.

Insulation resistance

The resistance to a specified impressed DC voltage between the terminals of each cup and the exposed conducting surfaces of the potentiometer, or between the terminals of each cup and the terminals of every other cup in the potentiometer, under prescribed conditions.

Glossary of Terms

Lateral runout

The perpendicularity of the mounting surface with respect to the rotational axis of the shaft measured on the mounting surface at a specified distance from the outside edge of the mounting surface. The shaft is held fixed and the body of the potentiometer is rotated with specified loads applied radial and axial to the body of the pot. The lateral runout is expressed in inches, TIR.

Load

The ability of a component to dissipate rated power for a specified length of time under specific operating conditions while remaining within allowable specifications.

Mechanical angle

The total travel of the shaft between integral stops; in potentiometers without stops, the mechanical travel is continuous.

Minimum resistance

The resistance measured between the wiper terminal and any other terminal with the shaft positioned to give the minimum value.

Noise

Any spurious variation in the electrical output not present in the input.

Non-wirewound

A resistive element made by screening a film of conductive plastic, cermet or carbon inks on a substrate, which may be fabricated from ceramic, phenolic or other type of insulator material.

Output ratio

The ratio of the output voltage to the designated input reference voltage. Unless otherwise specified, the reference voltage is the total applied voltage.

Output smoothness

A measurement of any instantaneous variation in the electrical output not present in the input.

Output voltage

The voltage between the wiper and the designated reference point. Unless otherwise specified, the designated reference point is the CCW terminal.

Potentiometer

A variable resistive device used in applications, which typically require frequent or even constant adjustment.

Phase

The relationship between channel A and channel B; the rising edge on channel A to rising edge on channel B measured in electrical degrees ($^{\circ}$ e).

Phase reference point

The reference point on a potentiometer cup, usually an output ratio or an intermediate tap. The reference point is used to align the cups in a multi-cup potentiometer.

Pilot diameter runout

The eccentricity of the pilot diameter with respect to the rotational axis of the shaft, measured on the pilot diameter. The shaft is held fixed and the body of the potentiometer is rotated with a specified load applied radial to the body of the pot. The eccentricity is expressed in inches, TIR.

Power rating

The maximum power that a component can dissipate under specified conditions while meeting specified performance requirements.

PPR Pulses per Revolution

(see Resolution)

Quadrature

The square wave output code generated by an incremental encoder. Normally, two output channels out of phase by 90° e.

Glossary of Terms

Resolution (encoder)

The number of full quadrature cycles per full shaft revolution (360 mechanical degrees). Each cycle can provide 1, 2, or 4 counts (i.e., X1, X2, and X4 decoding or multiplication) depending on how the signal is decoded. Resolution is normally stated in pulses per revolution (PPR).

Resolution (potentiometer)

A measure of the sensitivity to which the output ratio of the potentiometer may be set.

Rheostat

A variable resistor configured so that all the current flows through the wiper.

Roll-on/Roll-off

The abrupt output voltage or resistance change observed as the shaft is displaced from the end of mechanical travel into the electrical travel.

Rotational life

The ability of a component to withstand a specified number of cycles under specific operating conditions while remaining within allowable specifications.

Running torque

The rotational force required to sustain uniform shaft rotation at a specified speed in the clockwise or counterclockwise directions throughout the mechanical travel.

Shaft

The mechanical input interface of the potentiometer.

Shaft endplay

The total axial excursion of the shaft, measured at the end of the shaft with a specified axial load supplied alternately in opposite directions. Shaft endplay is expressed in inches.

Shaft radial play

The total radial excursion of the shaft, measured at a specified distance from the front surface of the component. A specified radial load is applied alternately in opposite directions at a specified point. Shaft radial play is expressed in inches.

Shaft revolution

One complete 360° turn of the shaft of a rotary encoder in a single direction.

Shaft runout

The eccentricity of the shaft diameter with respect to the rotational axis of the shaft, measured at a specified distance from the end of the shaft. The body of the potentiometer is held fixed and the shaft is rotated with a specified load applied radial to the shaft. The eccentricity is expressed in inches, TIR.

Solderability

The adhesion of molten solder to the terminals of a component, producing a continuous coat of solder without voids and pinholes under specified conditions.

Starting torque

The rotational force required to initiate shaft rotation of a rotary component in the clockwise or counterclockwise directions anywhere in the mechanical travel.

State

The logic levels generated in the output signal of a digital component (High, 1, true/Low, 0 false).

Stop strength

The maximum load that can be applied to the shaft at each mechanical stop for a specified period of time without permanent change of the stop positions greater than specified.

Glossary of Terms

Tap

An electrical connection fixed to an intermediate point on the resistive element.

Taper

The output curve of resistance measured between one end of the element and the wiper.

Temperature coefficient

The unit of change in resistance per °C temperature of resistance (TC) change from a reference temperature to a specified test temperature, expressed in PPM/°C.

Total applied voltage

The total voltage applied between the designated input terminals.

Total resistance (TR)

The DC resistance between the end terminals with the shaft positioned to give a maximum resistance value.

Voltage divider

A potentiometer configured in a circuit such that the resistive element is substituted for two resistors in series with the wiper providing an adjustable output voltage.

Voltage tap

An electrical connection fixed to the resistive element, which introduces no significant distortion in the output characteristic. A voltage tap usually has significant tap resistance and may not be capable of carrying the rated element current.

Wirewound

A resistive element made from multiple turns of wire around an insulated mandrel or cord.

Worldwide Sales Offices

Country	Phone	Fax
Benelux:	+31-70-3004333	+31-70-3004345
China:	+86-21-64821250	+86-21-64821249
France:	+33-254-735151	+33-254-735156
Germany:	+49-69-80078212	+49-69-80078299
Hong Kong:	+852-2411 5599	+852-2412 3611
Ireland:	+44-1276-691087	+44-1276-691088
Italy:	+39- 02-38900041	+39-02-38900042
Japan:	+81-49-269 3204	+81-49-269 3297
Singapore:	+65- 63461933	+65- 63461911
Switzerland:	+41-41-7685555	+41-41-7685510
Taiwan:	+886-2-25624117	+886-2-25624116
UK:	+44-1276-691087	+44-1276-691088
USA:	+1-909-781-5500	+1-909-781-5006
Non-Listed European Countries:	+41- 41-7685555	+41- 41-7685510

Technical Assistance

Region	Phone	Fax
Asia-Pacific:	+886-2-25624117	+886-2-25624116
Europe:	+41- 41-7685555	+41- 41-7685510
North America:	+1-909 781-5500	+1-909 781-5700

www.bourns.com

Bourns® products are available through an extensive network of manufacturer's representatives, agents and distributors. To obtain technical applications assistance, a quotation, or to place an order, contact a Bourns representative in your area.



Reliable Electronic Solutions

"Hybitron" is a registered trademark of Hybitron, Inc.
"Bourns" is a registered trademark of Bourns, Inc. in the U.S. and other countries.
COPYRIGHT © 2003, BOURNS, INC. • LITHO IN U.S.A. • DP 04/03 • 15M/S0213

X-ON Electronics

Largest Supplier of Electrical and Electronic Components

Click to view similar products for [Potentiometer Tools & Fixings](#) category:

Click to view products by [Bourns](#) manufacturer:

Other Similar products are found below :

[7071](#) [7071E](#) [7072E](#) [FKS-1/4](#) [H-38-3](#) [1220A](#) [ACCPOTDBB173190100](#) [H-858](#) [H-137-000](#) [H-37-5](#) [H-38-1](#) [7090E](#) [7074E](#) [RK14K1240A4S](#)
[HARDWARE](#) [H-862](#) [100P8](#) [H-80-1](#) [RKZ00020NA](#) [34-1032-1A](#) [006-1-0](#) [1-150](#) [T4845 09](#) [T4845 26](#) [H-38-2](#) [H-37-1](#) [DA-01](#) [P0700-21](#)
[P0700-7](#) [DA-02](#) [008T000](#) [T4845 13](#) [T4845 18](#) [T4857](#) [GSD-675](#) [H-114P](#) [H-83P](#) [H-90](#) [H-91](#) [DA-83](#) [DA-88](#) [6533E](#) [6591E](#) [7070E](#) [7091E](#)
[5465](#) [RKZ00023UA](#) [ZB4BD912](#) [T4844](#) [T4847](#) [T4847 0](#)