



**BOURNS®**

### Features

- Formerly J.W. Miller® model
- Available in E12 series
- Inductance as low as 1.0  $\mu$ H
- Current rating up to 9.4 A
- RoHS compliant\*

### Applications

- Input/output of DC/DC converters
- Power supplies for:
  - Portable communication equipment
  - Camcorders
  - LCD TVs
  - Car radios

## PM125SH Series - Shielded SMD Power Inductor

### Electrical Specifications

Bourns Part No.	Inductance 100 kHz		Q Typ.	Test Frequency (MHz)	SRF Typ. (MHz)	RDC Max. (m $\Omega$ )	I rms Max. (A)	I sat Typ. (A)
	( $\mu$ H)	Tol. %						
PM125SH-100M-RC	10	$\pm 20$	32	2.52	21.00	20.0	5.50	5.50
PM125SH-120M-RC	12	$\pm 20$	27	2.52	19.40	23.0	5.20	5.00
PM125SH-150M-RC	15	$\pm 20$	25	2.52	17.60	27.0	5.00	4.60
PM125SH-180M-RC	18	$\pm 20$	28	2.52	15.50	36.0	4.20	3.90
PM125SH-220M-RC	22	$\pm 20$	29	2.52	13.40	43.0	4.00	3.70
PM125SH-270M-RC	27	$\pm 20$	26	2.52	12.70	45.0	3.60	3.30
PM125SH-330M-RC	33	$\pm 20$	27	2.52	9.97	60.0	3.00	2.80
PM125SH-390M-RC	39	$\pm 20$	22	2.52	10.40	70.0	2.80	2.70
PM125SH-470M-RC	47	$\pm 20$	22	2.52	7.63	86.0	2.60	2.50
PM125SH-560M-RC	56	$\pm 20$	24	2.52	7.92	100.0	2.30	2.20
PM125SH-680M-RC	68	$\pm 20$	22	2.52	7.43	110.0	2.10	2.10
PM125SH-820M-RC	82	$\pm 20$	25	2.52	6.85	145.0	1.95	1.90
PM125SH-101M-RC	100	$\pm 20$	26	0.796	6.07	180.0	1.70	1.70
PM125SH-121K-RC	120	$\pm 10$	26	0.796	5.50	210.0	1.65	1.65
PM125SH-151K-RC	150	$\pm 10$	20	0.796	5.00	260.0	1.55	1.55
PM125SH-181K-RC	180	$\pm 10$	26	0.796	4.50	320.0	1.40	1.40
PM125SH-221K-RC	220	$\pm 10$	22	0.796	4.20	380.0	1.38	1.30
PM125SH-271K-RC	270	$\pm 10$	20	0.796	3.60	450.0	1.30	1.20
PM125SH-331K-RC	330	$\pm 10$	22	0.796	3.20	580.0	1.15	1.10
PM125SH-391K-RC	390	$\pm 10$	20	0.796	2.80	700.0	1.08	1.00
PM125SH-471K-RC	470	$\pm 10$	18	0.796	2.60	820.0	0.95	0.90
PM125SH-561K-RC	560	$\pm 10$	22	0.796	2.40	1000.0	0.88	0.80
PM125SH-681K-RC	680	$\pm 10$	18	0.796	2.20	1150.0	0.80	0.75
PM125SH-821K-RC	820	$\pm 10$	20	0.796	2.00	1500.0	0.73	0.63
PM125SH-102K-RC	1000	$\pm 10$	30	0.252	1.80	1700.0	0.68	0.60

### General Specifications

Test Voltage ..... 0.1 V  
 Reflow Soldering .. 230 °C, 50 sec. max.  
 Operating Temperature  
 ..... -40 °C to +125 °C  
 (Temperature rise included)  
 Storage Temperature .. -40 °C to +125 °C  
 Resistance to Soldering Heat  
 ..... 260 °C for 10 sec.

### Materials

Core ..... Ferrite DR and RI  
 Wire ..... Enameled copper wire 130  
 Terminal ..... Cu/Ni/Sn  
 Rated Current  
 ..... Ind. drop 25 % typ. at Isat  
 Temperature Rise ..... 40 °C max.  
 at rated I rms  
 Packaging ..... 500 pcs. per reel

### Product Dimensions

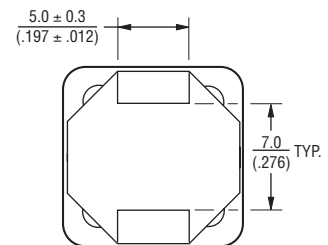
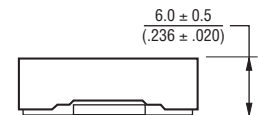
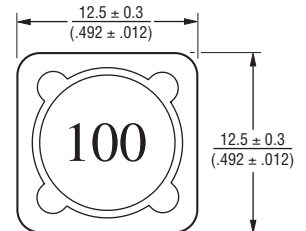

DIMENSIONS:  $\frac{\text{MM}}{\text{(INCHES)}}$

### Electrical Schematic

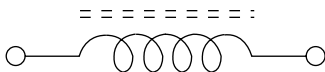

### Recommended Layout

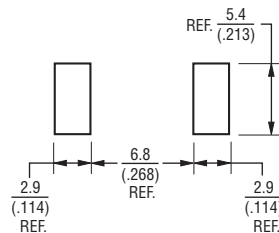

\*RoHS Directive 2002/95/EC Jan. 27, 2003 including annex and RoHS Recast 2011/65/EU June 8, 2011.  
 Specifications are subject to change without notice.  
 Customers should verify actual device performance in their specific applications.

# PM125SH Series - Shielded SMD Power Inductor

**BOURNS®**

## Packaging Specifications

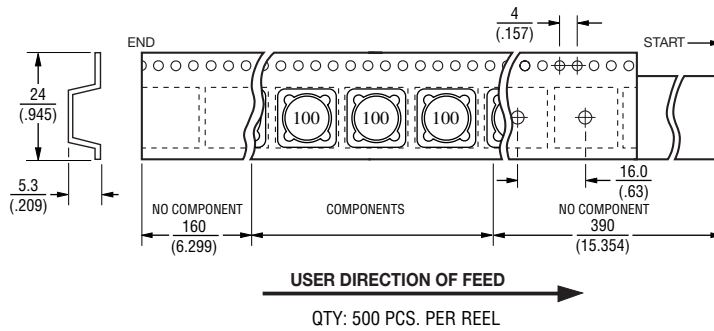
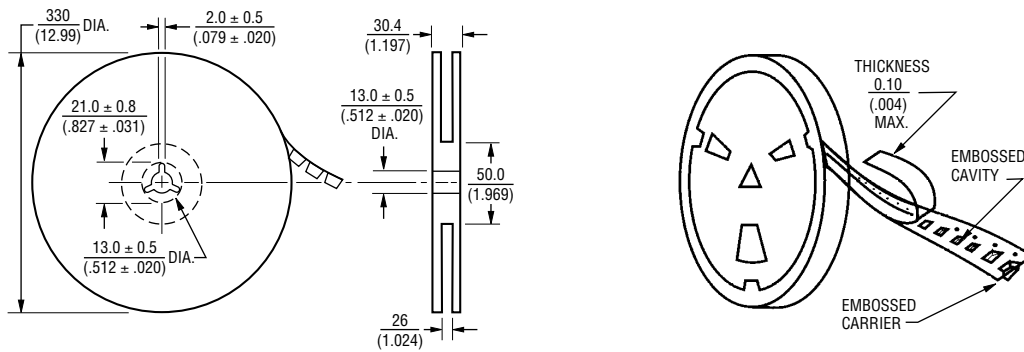

DIMENSIONS:  $\frac{\text{MM}}{\text{(INCHES)}}$

REV. 05/11

Specifications are subject to change without notice.  
Customers should verify actual device performance in their specific applications.

## X-ON Electronics

Largest Supplier of Electrical and Electronic Components

*Click to view similar products for [Fixed Inductors](#) category:*

*Click to view products by [Bourns](#) manufacturer:*

Other Similar products are found below :

[CR43NP-680KC](#) [CR54NP-820KC](#) [CR54NP-8R5MC](#) [CTX32CT-100](#) [70F224AI](#) [MGDQ4-00004-P](#) [MHL1ECTTP18NJ](#) [MHL1JCTTD12NJ](#)  
[PE-51506NL](#) [PE-53601NL](#) [PE-53602NL](#) [PE-53630NL](#) [PE-53824SNLT](#) [PE-92100NL](#) [PG0434.801NLT](#) [PG0936.113NLT](#) [9310-16](#) [PM06-2N7](#) [PM06-39NJ](#) [A01TK](#) [1206CS-471XJ](#) [HC2-2R2TR](#) [HC2LP-R47-R](#) [HC3-2R2-R](#) [1206CS-151XG](#) [RCH664NP-140L](#) [RCH664NP-4R7M](#)  
[RCH8011NP-221L](#) [RCP1317NP-332L](#) [RCP1317NP-391L](#) [RCR1010NP-470M](#) [RCR110DNP-331L](#) [DH2280-4R7M](#) [DS1608C-106](#) [ASPI-4020HI-R10M-T](#) [B10TJ](#) [B82477P4333M](#) [B82498B3101J000](#) [B82498B3680J000](#) [ELJ-RE27NJF2](#) [1812CS-153XJ](#) [1812CS-183XJ](#) [1812CS-223XJ](#) [1812LS-104XJ](#) [1812LS-105XJ](#) [1812LS-124XJ](#) [1812LS-154XJ](#) [1812LS-223XJ](#) [1812LS-224XJ](#) [1812LS-563XJ](#)