



Features

- 3 kA, 8/20 μ s surge capability
- Low clamping voltage under surge
- Bidirectional TVS
- Surface mount package

Applications

- High power DC bus protection

PTVS3-xxxC-SH Series High Current TVS Diodes

General Information

The PTVS3-xxxC-SH range of high current bidirectional TVS diodes is designed for use in high power DC bus clamping applications. These devices offer bidirectional port protection and are available with standoff voltage ratings of 58 V and 76 V.

The devices are RoHS* compliant. They also meet IEC 61000-4-5 8/20 μ s current surge requirements.



Absolute Maximum Ratings (@ $T_A = 25^\circ\text{C}$ Unless Otherwise Noted)

Rating		Symbol	Value	Unit
Repetitive Standoff Voltage	PTVS3-058C-SH PTVS3-076C-SH	V_{WM}	58 76	V
Peak Current Rating per 8/20 μ s IEC 61000-4-5		I_{PPM}	3	kA
Operating Junction Temperature Range		T_J	-55 to +125	$^\circ\text{C}$
Storage Temperature Range		T_S	-55 to +150	$^\circ\text{C}$

Electrical Characteristics (@ $T_A = 25^\circ\text{C}$ Unless Otherwise Noted)

Parameter	Test Conditions		Min.	Typ.	Max.	Unit
I_D Standby Current	$V_D = V_{WM}$				10	μA
$V_{(BR)}$ Breakdown Voltage	$I_{BR} = 10\text{ mA}$	PTVS3-058C-SH PTVS3-076C-SH	64 85	67 90	70 95	V
V_C Clamping Voltage (1)	$I_{PP} = 3\text{ kA}$	PTVS3-058C-SH PTVS3-076C-SH			110 140	V
$V_{(BR)}$ Temperature Coefficient				0.1		$\%/^\circ\text{C}$
C Capacitance	F = 10 kHz, $V_d = 1\text{ Vrms}$	PTVS3-058C-SH PTVS3-076C-SH		2.3 1.7		nF

(1) V_C measured at the time which is coincident with the peak surge current.

BOURNS®

Asia-Pacific: Tel: +886-2 2562-4117 • Fax: +886-2 2562-4116

EMEA: Tel: +36 88 520 390 • Fax: +36 88 520 211

The Americas: Tel: +1-951 781-5500 • Fax: +1-951 781-5700

www.bourns.com

*RoHS Directive 2002/95/EC Jan. 27, 2003 including annex and RoHS Recast 2011/65/EU June 8, 2011.

Specifications are subject to change without notice.

The device characteristics and parameters in this data sheet can and do vary in different applications and actual device performance may vary over time. Users should verify actual device performance in their specific applications.

PTVS3-xxxC-SH Series High Current TVS Diodes

BOURNS®

Performance Graphs

V-I Characteristic

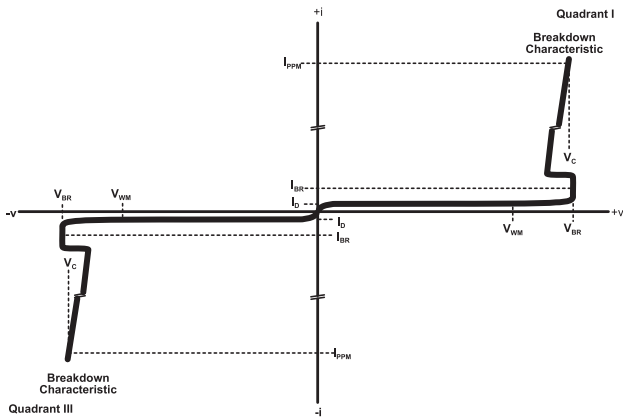

Typical V_{BR} vs. Junction Temperature

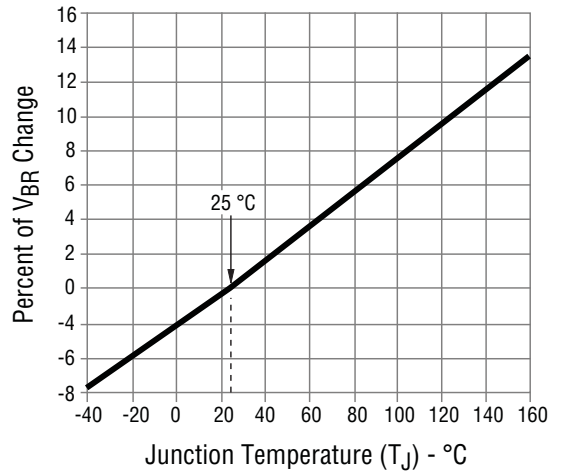

Typical Surge Current Derating

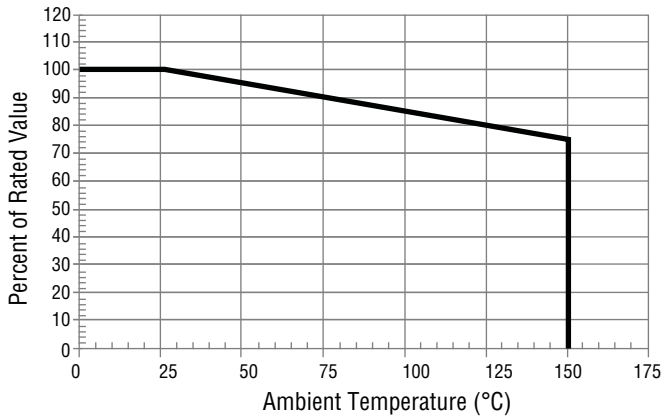

This graph shows the typical device surge current derating versus ambient temperature when subjected to the 8/20 μ s current waveform per the IEC 61000-4-5 specification. This device is not intended for continuous operation at temperatures above 125 °C.

Current 8/20 μ s Waveform per IEC 61000-4-5

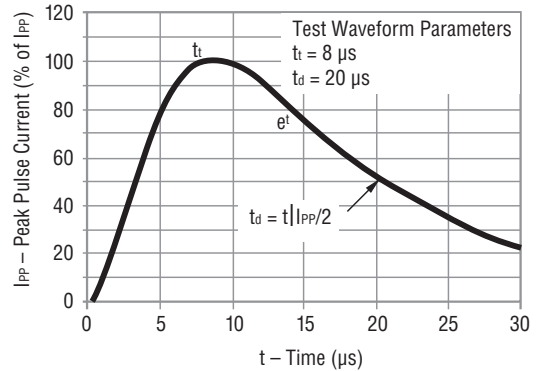

Specifications are subject to change without notice.

The device characteristics and parameters in this data sheet can and do vary in different applications and actual device performance may vary over time. Users should verify actual device performance in their specific applications.

PTVS3-xxxC-SH Series High Current TVS Diodes



Product Dimensions

This is a Pb free product, with epoxy encapsulations meeting UL Class 94V-0. Ag plated leads meet solderability requirements of JESD22-B102. Package dimensions are shown below.

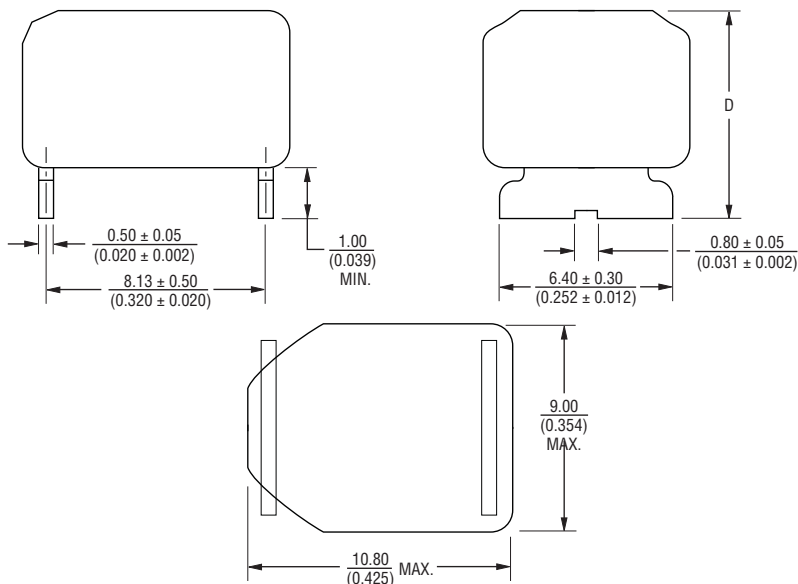

Device	Dimension D
PTVS3-058C-SH	$\frac{7.00 \pm 0.50}{(0.276 \pm 0.020)}$
PTVS3-076C-SH	$\frac{7.90 \pm 0.50}{(0.311 \pm 0.020)}$

DIMENSIONS: $\frac{\text{MM}}{(\text{INCHES})}$

Recommended Printed Wiring Land Pattern Dimensions

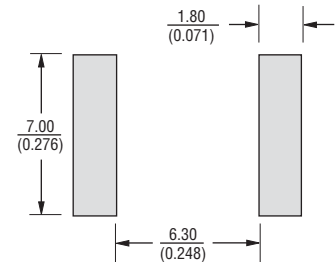

Typical Part Marking

PTVS3-058C-SH 3058
PTVS3-076C-SH 3076

How to Order

PTVS 3 - xxx C - S H

Series _____
PTVS = Power TVS High Current Diode

Peak Current Rating _____
3 = 3 kA

Repetitive Standoff Voltage _____
058 = 58 V
076 = 76 V

Suffix _____
C = Bidirectional Device

Package _____
S = Surface Mount

Temperature _____
H = High Temperature Series

Application

A typical application for Power TVS products includes DC power line protection.

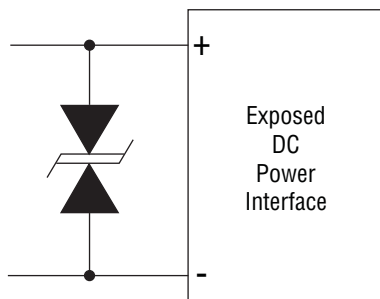

X-ON Electronics

Largest Supplier of Electrical and Electronic Components

Click to view similar products for [ESD Suppressors / TVS Diodes](#) category:

Click to view products by [Bourns](#) manufacturer:

Other Similar products are found below :

[60KS200C](#) [D12V0H1U2WS-7](#) [D18V0L1B2LP-7B](#) [82356050220](#) [D5V0M5U6V-7](#) [NTE4902](#) [P4KE27CA](#) [P6KE11CA](#) [P6KE39CA-TP](#)
[P6KE8.2A](#) [SA110CA](#) [SA60CA](#) [SA64CA](#) [SMBJ12CATR](#) [SMBJ8.0A](#) [SMLJ30CA-TP](#) [ESD101-B1-02ELS E6327](#) [ESD112-B1-02EL E6327](#)
[ESD119B1W01005E6327XTSA1](#) [ESD5V0L1B02VH6327XTSA1](#) [ESD7451N2T5G](#) [19180-510](#) [CPDT-5V0USP-HF](#) [3.0SMCJ33CA-F](#)
[3.0SMCJ36A-F](#) [HSPC16701B02TP](#) [D3V3Q1B2DLP3-7](#) [D55V0M1B2WS-7](#) [DESD5V0U1BL-7B](#) [DRTR5V0U4SL-7](#) [SCM1293A-04SO](#)
[ESD200-B1-CSP0201 E6327](#) [ESD203-B1-02EL E6327](#) [SM12-7](#) [SMF8.0A-TP](#) [SMLJ45CA-TP](#) [CEN955 W/DATA](#) [82350120560](#)
[82356240030](#) [VESD12A1A-HD1-GS08](#) [CPDUR5V0R-HF](#) [CPDUR24V-HF](#) [CPDQC5V0U-HF](#) [CPDQC5V0USP-HF](#) [CPDQC5V0-HF](#)
[D1213A-01LP4-7B](#) [D1213A-02WL-7](#) [ESDLIN1524BJ-HQ](#) [5KP100A](#) [5KP15A](#)