



## SinglFuse™ SF-1206SxxxW Series Features

- Single blow fuse for overcurrent protection
- 3216 (EIA 1206) footprint
- Slow blow fuse
- UL 248-14 listed
- RoHS compliant\* and halogen free\*\*
- Wire core SMD design
- Surface mount packaging for automated assembly

## SF-1206SxxxW Series - Slow Blow Wire Core Surface Mount Fuses

### Electrical Characteristics

Model	Rated Current (Amps)	Fusing Time	Resistance (Ω) Typ.***	Rated Voltage	Interrupting Rating	Typical I <sup>2</sup> t (A <sup>2</sup> s) ****
SF-1206S150W-2	1.50	Open within 5 sec. at 250 % rated current	0.050	DC 65 V	DC 65 V 50 A	0.37
SF-1206S160W-2	1.60		0.043			0.52
SF-1206S200W-2	2.00		0.032			0.88
SF-1206S250W-2	2.50		0.028			1.10
SF-1206S300W-2	3.00		0.022			1.90
SF-1206S315W-2	3.15		0.020			2.20
SF-1206S350W-2	3.50		0.018			2.60
SF-1206S400W-2	4.00		0.016			3.30
SF-1206S500W-2	5.00		0.013	5.40		
SF-1206S630W-2	6.30		0.010	8.90		
SF-1206S700W-2	7.00		0.0092	10.40		
SF-1206S800W-2	8.00		0.0084	13.50		
SF-1206S1000W-2	10.00		0.0050	11.20		
SF-1206S1200W-2	12.00		0.0041	15.00		
SF-1206S1500W-2	15.00		0.0035	24.50		

\*\*\* Resistance value measured with ≤10 % rated current at 25 °C ambient.

\*\*\*\* Melting I<sup>2</sup>t calculated at 0.001 second pre-arcing time.

### Reliability Testing

No.	Test	Requirement	Test Condition	Test Reference
1	Reflow and bend	DCR change ≤ 20 % (≤ 10 % for ≤1 A) No mechanical damage	3 reflows at 245 °C followed by a 2 mm bend	Refer to STP document
2	Solderability	Minimum 90 % coverage	One dip at 245 °C for 5 seconds	MIL-STD-202 Method 208
3	Soldering heat resistance	DCR change ≤ 20 % (≤ 10 % for ≤1 A) New solder coverage ≤ 75 %	One dip at 260 °C for 10 seconds	MIL-STD-202 Method 210
4	Moisture resistance	DCR change ≤ ±15 % No excessive corrosion	10 cycles	MIL-STD-202 Method 106
5	Salt spray	DCR change ≤ ±10 % No excessive corrosion	48 hour exposure, 5 % salt solution	MIL-STD-202 Method 101
6	Mechanical vibration	DCR change ≤ ±10 % No mechanical damage	0.4 inch D.A. or 30 G between 5-3000 Hz	MIL-STD-202 Method 204
7	Mechanical shock	DCR change ≤ ±10 % No mechanical damage	1500 G, 0.5 ms, half-sine shocks	MIL-STD-202 Method 213
8	Thermal Shock	DCR change ≤ ±10 % No mechanical damage	100 cycles between -65 °C and +125 °C	MIL-STD-202 Method 107
9	Life	No electrical "opens" during testing Voltage drop change shall be less than ±20 % of initial value	80 % rated current (75 % for < 1 A fuses) for 2000 hours at ambient temperature +25 °C	Refer to STP document

### Agency Recognition

UL File Number ..... E198545

<http://www.ul.com/> Follow link to Online Certificates Directory, then enter UL File No. E198545, or [click here](#)

\* RoHS Directive 2015/863, Mar 31, 2015 and Annex..

\*\* Bourns considers a product to be "halogen free" if (a) the Bromine (Br) content is 900 ppm or less; (b) the Chlorine (Cl) content is 900 ppm or less; and (c) the total Bromine (Br) and Chlorine (Cl) content is 1500 ppm or less.

"SinglFuse" is a trademark of Bourns, Inc.

Specifications are subject to change without notice.

The device characteristics and parameters in this data sheet can and do vary in different applications and actual device performance may vary over time.

Users should verify actual device performance in their specific applications.

# SingIFuse™ SF-1206SxxxW Series Applications

- LCD monitors
- Backlight drivers
- Set top boxes
- DC/DC converters
- Notebooks / ultrabooks
- Low voltage lighting power
- Industrial controllers

## SF-1206SxxxW Series - Slow Blow Wire Core Surface Mount Fuses **BOURNS®**

### Environmental Characteristics

Operating Temperature.....	-55 °C to +125 °C
Storage Conditions	
Temperature .....	+5 °C to +35 °C
Humidity.....	40 % to 75 %
Shelf Life.....	2 years from manufacturing date
Moisture Sensitivity Level.....	1
ESD Classification (HBM).....	Class 6

### Typical Part Marking

Represents total content. Layout may vary.



RATED CURRENT (A)

G = 1.50	N = 5.00
T = 1.60	O = 6.30
I = 2.00	P = 7.00
J = 2.50	R = 8.00
K = 3.00	Q = 10.00
V = 3.15	X = 12.00
L = 3.50	Y = 15.00
M = 4.00	

### How to Order

**SF - 1206 S 150 W - 2**

SingIFuse™  
 Product Designator  
 SMD Footprint  
 1206 = 3216 (EIA1206) size  
 Fuse Blow Type  
 S = Slow Blow  
 Rated Current  
 150 ~ 1500 (1.50 A ~ 15.00 A)  
 Structure Type  
 W = Wire Core  
 Packaging Type  
 - 2 = Tape & Reel

### Construction

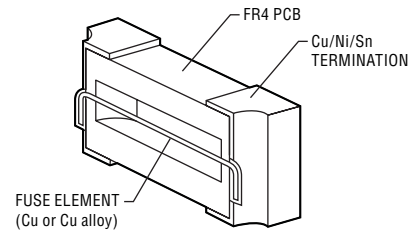

### Packaging Quantity

3,500 pieces per 7-inch reel

### Product Dimensions

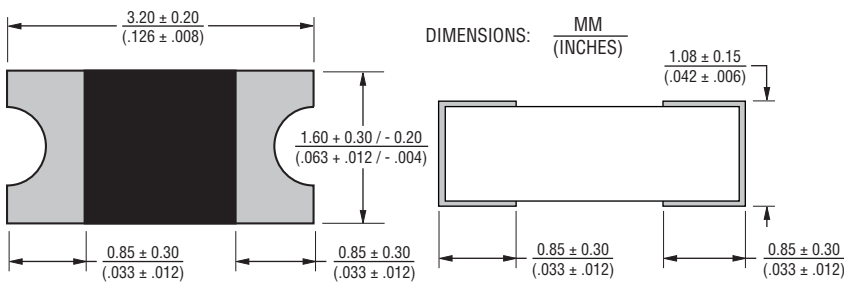

### Recommended Pad Layout

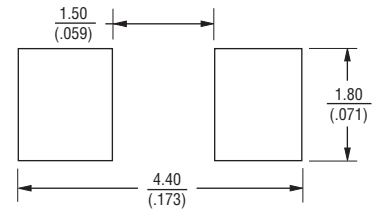

### Current Rating Thermal Derating Curve

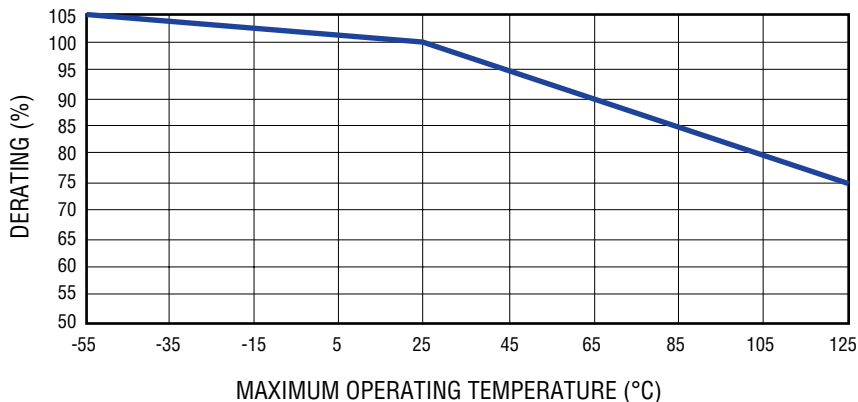

Specifications are subject to change without notice. The device characteristics and parameters in this data sheet can and do vary in different applications and actual device performance may vary over time. Users should verify actual device performance in their specific applications.

**Solder Reflow Recommendations**

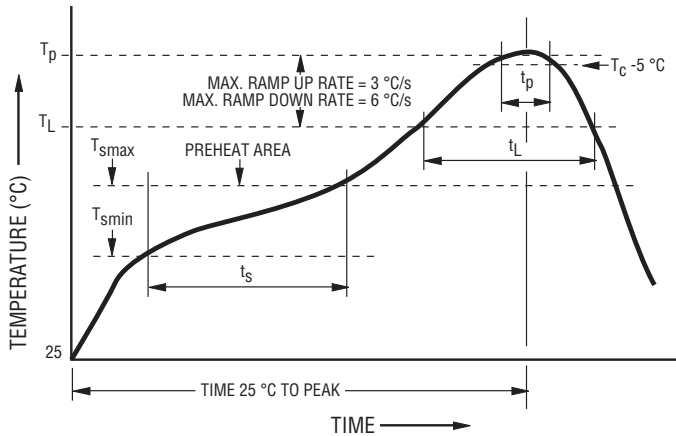

Profile Feature	Pb-Free Assembly
Preheat / Soak: Temperature Min. ( $T_{smin}$ ) Temperature Max. ( $T_{smax}$ ) Time ( $t_s$ ) from ( $T_{smin}$ to $T_{smax}$ )	150 °C 200 °C 60~120 seconds
Ramp Up Rate ( $T_l$ to $T_d$ )	3 °C / second max.
Liquidous Temperature ( $T_l$ ) Time ( $t_L$ ) maintained above $T_l$	217 °C 60~150 seconds
Peak Package Body Temperature ( $T_d$ )	260 °C
Time ( $t_p$ )* within 5 °C of the specified classification temperature ( $T_c$ )	30 seconds*
Ramp Down Rate ( $T_d$ to $T_l$ )	6 °C / second max.
Time 25 °C to Peak Temperature	8 minutes max.

\* Tolerance for peak profile temperature ( $T_p$ ) is defined as a supplier minimum and a user maximum.

**Recommended Temperature Profile for Wave Soldering**

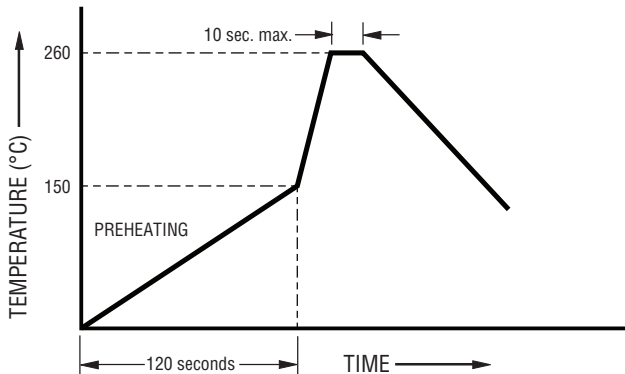

Wave soldering is suitable for 1206 size models.

Average Pre-Arcing Time vs. Current Curves

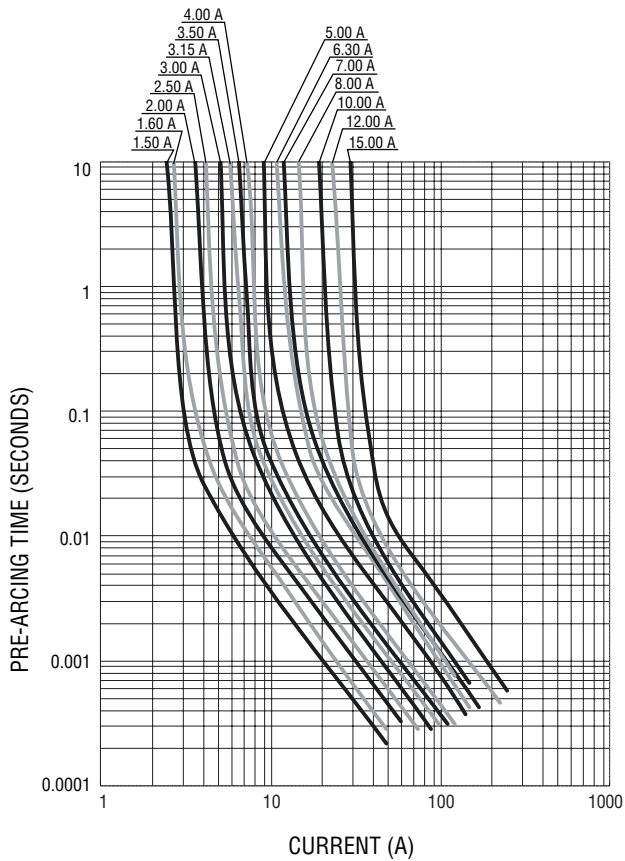

Average I<sup>2</sup>t vs. t Curves

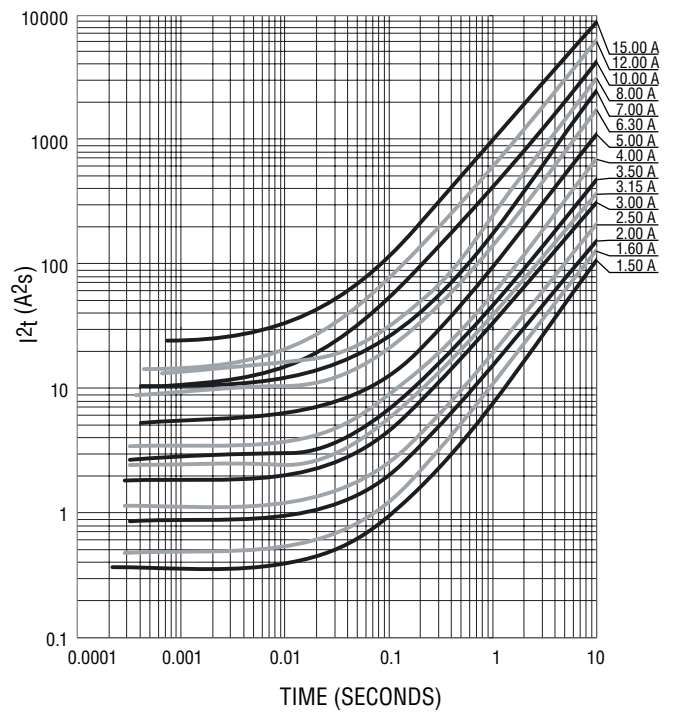

**BOURNS®**

Asia-Pacific: Tel: +886-2 2562-4117 • Email: asiacus@bourns.com

EMEA: Tel: +36 88 520 390 • Email: eurocus@bourns.com

The Americas: Tel: +1-951 781-5500 • Email: americus@bourns.com

www.bourns.com

# SF-1206SxxxW Series Tape and Reel Packaging Specifications

# BOURNS®

Tape Dimensions	SF-1206SxxxW Series per EIA 481-2
W	$\frac{8.10 \pm 0.20}{(.319 \pm .008)}$
P <sub>0</sub>	$\frac{4.0 \pm 0.10}{(.157 \pm .004)}$
P <sub>1</sub>	$\frac{4.0 \pm 0.10}{(.157 \pm .004)}$
P <sub>2</sub>	$\frac{2.0 \pm 0.05}{(.079 \pm .002)}$
A <sub>0</sub>	$\frac{2.05 \pm 0.10}{(.081 \pm .004)}$
B <sub>0</sub>	$\frac{3.50 \pm 0.10}{(.138 \pm .004)}$
F	$\frac{3.50 \pm 0.05}{(.138 \pm .002)}$
E <sub>1</sub>	$\frac{1.75 \pm 0.10}{(.069 \pm .004)}$
D <sub>0</sub>	$\frac{1.50 \pm 0.10}{(.059 \pm .004)}$
K <sub>0</sub>	$\frac{1.30 \pm 0.10}{(.051 \pm .004)}$
T	$\frac{0.22 \pm 0.05}{(.009 \pm .002)}$

PACKAGING: Plastic tape, 3,500 pcs. per reel

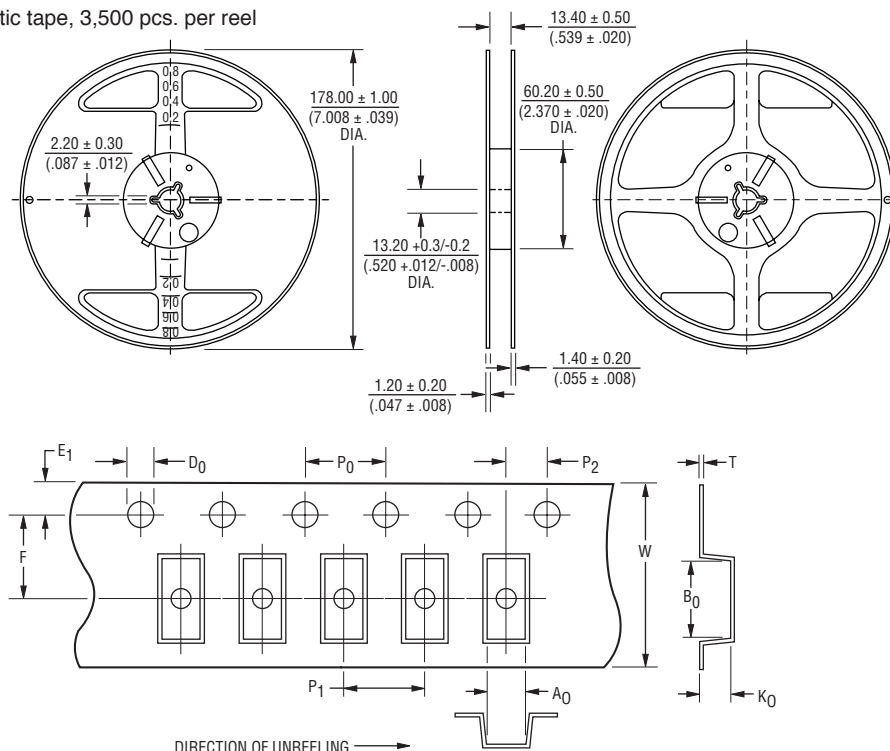

DIMENSIONS:  $\frac{\text{MM}}{(\text{INCHES})}$

Specifications are subject to change without notice.  
The device characteristics and parameters in this data sheet can and do vary in different applications and actual device performance may vary over time.  
Users should verify actual device performance in their specific applications.

## X-ON Electronics

Largest Supplier of Electrical and Electronic Components

*Click to view similar products for [Surface Mount Fuses](#) category:*

*Click to view products by [Bourns](#) manufacturer:*

Other Similar products are found below :

[FHC20402ADTP](#) [NFVC6125S0R50TRF](#) [SFT-125MA](#) [TF16SN2.00TTD](#) [TR/3216LR-500MA](#) [CCP2B20TTE](#) [FCC16501ABTP](#)  
[FHC16322ADTP](#) [0308.250UR](#) [0308.375UR](#) [0308.500UR](#) [030801.5UR](#) [FCC16202ABTP](#) [03081.25UR](#) [F0603G0R03FNTR](#) [SKY87604-11](#)  
[3404.0110.22](#) [SEF 0.375A 125V \(G\)](#) [1211015](#) [S1206-F-3.0A](#) [9321315278](#) [S0603-F-4.0A](#) [SMT1315AP](#) [0603TD-4A](#) [1240FH-30A](#)  
[R451003.L](#) [R451.500L](#) [R451001.L](#) [3-103-119](#) [3-103-123](#) [3-103-127](#) [0154002.DRL](#) [0154008.DRL](#) [0154.500DRL](#) [189140.1,25](#) [189140.0,8](#)  
[189140.0,4](#) [189140.0,63](#) [189140.0,25](#) [0468003.WR](#) [0494001.NRHF](#) [0494002.NRHF](#) [0494003.NRHF](#) [049402.5NRHF](#) [049403.5NRHF](#)  
[0494.250NRHF](#) [0494.375NRHF](#) [0494.500NRHF](#) [CF06V3T1R60](#) [CF06V3T2R50](#)