



TISP5070H3BJ THRU TISP5190H3BJ

FORWARD-CONDUCTING UNIDIRECTIONAL THYRISTOR OVERVOLTAGE PROTECTORS

TISP5xxxH3BJ Overvoltage Protector Series

Analogue Line Card and ISDN Protection

- Analogue SLIC
- ISDN U Interface
- ISDN Power Supply

8 kV 10/700, 200 A 5/310 ITU-T K.20/21/45 rating

Ion-Implanted Breakdown Region

- Precise and Stable Voltage

Low Voltage Overshoot under Surge

Device Name	V_{DRM} V	$V_{(BO)}$ V
TISP5070H3BJ	-58	-70
TISP5080H3BJ	-65	-80
TISP5095H3BJ	-75	-95
TISP5110H3BJ	-80	-110
TISP5115H3BJ	-90	-115
TISP5150H3BJ	-120	-150
TISP5190H3BJ	-160	-190

Rated for International Surge Wave Shapes

Wave Shape	Standard	I_{PPSM} A
2/10	GR-1089-CORE	500
8/20	ANSI C62.41	300
10/160	TIA-968-A	250
10/700	ITU-T K.20/21/45	200
10/560	TIA-968-A	160
10/1000	GR-1089-CORE	100

Agency Recognition

Description	
UL	File Number: E215609

SMB Package (Top View)

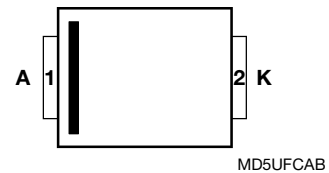

Device Symbol



..... UL Recognized Component

Description

These devices are designed to limit overvoltages on the telephone and data lines. Overvoltages are normally caused by a.c. power system or lightning flash disturbances which are induced or conducted on to the telephone line. A single device provides 2-point protection and is typically used for the protection of ISDN power supply feeds. Two devices, one for the Ring output and the other for the Tip output, will provide protection for single supply analogue SLICs. A combination of three devices will give a low capacitance protector network for the 3-point protection of ISDN lines.

The protector consists of a voltage-triggered unidirectional thyristor with an anti-parallel diode. Negative overvoltages are initially clipped by breakdown clamping until the voltage rises to the breakover level, which causes the device to crowbar into a low-voltage on state. This low-voltage on state causes the current resulting from the overvoltage to be safely diverted through the device. The high crowbar holding current helps prevent d.c. latchup as the diverted current subsides. Positive overvoltages are limited by the conduction of the anti-parallel diode.

How to Order

Device	Package	Carrier	Order As	Marking Code	Std. Quantity
TISP5xxxH3BJ	BJ (J-Bend DO-214AA/SMB)	Embossed Tape Reeled	TISP5xxxH3BJR-S	5xxxH3	3000

Insert xxx value corresponding to protection voltages of 070, 080, 110, 115 and 150.

JANUARY 1998 – REVISED JULY 2019

*RoHS Directive 2015/863, Mar 31, 2015 and Annex. Specifications are subject to change without notice.

Users should verify actual device performance in their specific applications.

The products described herein and this document are subject to specific legal disclaimers as set forth on the last page of this document, and at www.bourns.com/docs/legal/disclaimer.pdf.



WARNING Cancer and Reproductive Harm
www.P65Warnings.ca.gov

TISP5xxxH3BJ Overvoltage Protection Series

BOURNS®

Absolute Maximum Ratings, $T_A = 25\text{ °C}$ (Unless Otherwise Noted)

Rating	Symbol	Value	Unit
Repetitive peak off-state voltage (see Note 1)	'5070H3BJ	-58	V
	'5080H3BJ	-65	
	'5095H3BJ	-75	
	'5110H3BJ	-80	
	'5115H3BJ	-90	
	'5150H3BJ	-120	
	'5190H3BJ	-160	
Non-repetitive peak impulse current (see Notes 2, 3 and 4) 2/10 μs (GR-1089-CORE, 2/10 μs voltage wave shape) 8/20 μs (IEC 61000-4-5, 1.2/50 μs voltage, 8/20 μs current combination wave generator) 10/160 μs (TIA-968-A, 10/160 μs voltage wave shape) 5/200 μs (VDE 0433, 10/700 μs voltage waveshape) 0.2/310 μs (I3124, 0.5/700 μs waveshape) 5/310 μs (ITU-T K.44, 10/700 μs voltage waveshape used in K.20/21/45) 5/310 μs (FTZ R12, 10/700 μs voltage waveshape) 10/560 μs (TIA-968-A, 10/560 μs voltage wave shape) 10/1000 μs (GR-1089-CORE, 10/1000 μs voltage wave shape)	I_{PPSM}	± 500 ± 300 ± 250 ± 220 ± 200 ± 200 ± 200 ± 160 ± 100	A
Non-repetitive peak on-state current (see Notes 2, 3 and 5) 20 ms, 50 Hz (full sine wave) 16.7 ms, 60 Hz (full sine wave) 1000 s 50 Hz/60 Hz a.c.	I_{TSM}	55 60 2.1	A
Initial rate of rise of on-state current, GR-1089-CORE 2/10 μs wave shape	di_T/dt	± 400	A/ μs
Junction temperature	T_J	-40 to +150	$^{\circ}\text{C}$
Storage temperature range	T_{stg}	-65 to +150	$^{\circ}\text{C}$

- NOTES: 1. See Figure 9 for voltage values at lower temperatures.
2. Initially the device must be in thermal equilibrium with $T_J = 25\text{ °C}$.
3. The surge may be repeated after the device returns to its initial conditions.
4. See Figure 10 for current ratings at other temperatures.
5. EIA/JESD51-2 environment and EIA/JESD51-3 PCB with standard footprint dimensions connected with 5 A rated printed wiring track widths. Derate current values at $-0.61\text{ \%/}^{\circ}\text{C}$ for ambient temperatures above 25 °C . See Figure 8 for current ratings at other durations.

Electrical Characteristics, $T_A = 25\text{ °C}$ (Unless Otherwise Noted)

Parameter	Test Conditions	Min	Typ	Max	Unit
I_{DRM} Repetitive peak off-state current	$V_D = V_{DRM}$ $T_A = 25\text{ °C}$ $T_A = 85\text{ °C}$			-5 -10	μA
$V_{(BO)}$ Breakover voltage	$dv/dt = -250\text{ V/ms}$, $R_{SOURCE} = 300\ \Omega$			-70 -80 -95 -110 -115 -150 -190	V
$V_{(BO)}$ Impulse breakover voltage	$dv/dt \geq -1000\text{ V}/\mu\text{s}$, Linear voltage ramp, Maximum ramp value = -500 V $di/dt = -20\text{ A}/\mu\text{s}$, Linear current ramp, Maximum ramp value = -10 A			-80 -90 -105 -120 -125 -160 -200	V

JANUARY 1998 – REVISED JULY 2019

Specifications are subject to change without notice.

Users should verify actual device performance in their specific applications.

The products described herein and this document are subject to specific legal disclaimers as set forth on the last page of this document, and at www.bourns.com/docs/legal/disclaimer.pdf.

TISP5xxxH3BJ Overvoltage Protection Series

BOURNS®

Electrical Characteristics, $T_A = 25\text{ }^\circ\text{C}$ (Unless Otherwise Noted)

Parameter	Test Conditions	Min	Typ	Max	Unit
$I_{(BO)}$ Breakover current	$dv/dt = -250\text{ V/ms}$, $R_{SOURCE} = 300\ \Omega$	-150		-600	mA
V_F Forward voltage	$I_F = 5\text{ A}$, $t_W = 500\ \mu\text{s}$			3	V
V_{FRM} Peak forward recovery voltage	$dv/dt \leq +1000\text{ V}/\mu\text{s}$, Linear voltage ramp, Maximum ramp value = +500 V $di/dt = +20\text{ A}/\mu\text{s}$, Linear current ramp, Maximum ramp value = +10 A			5	V
V_T On-state voltage	$I_T = -5\text{ A}$, $t_W = 500\ \mu\text{s}$			-3	V
I_H Holding current	$I_T = -5\text{ A}$, $di/dt = +30\text{ mA/ms}$	-150		-600	mA
dv/dt Critical rate of rise of off-state voltage	Linear voltage ramp, maximum ramp value $< 0.85V_{DRM}$	-5			kV/ μs
I_D Off-state current	$V_D = -50\text{ V}$ $T_A = 85\text{ }^\circ\text{C}$			-10	μA
C_O Off-state capacitance (see Note 6)	$f = 1\text{ MHz}$, $V_d = 1\text{ V rms}$, $V_D = -1\text{ V}$	'5070H3BJ	300	420	pF
		'5080H3BJ	280	390	
		'5095H3BJ	260	365	
		'5110H3BJ	240	335	
		'5115H3BJ	214	300	
		'5150H3BJ	140	195	
	$f = 1\text{ MHz}$, $V_d = 1\text{ V rms}$, $V_D = -2\text{ V}$	'5190H3BJ	140	195	
		'5070H3BJ	260	365	
		'5080H3BJ	245	345	
		'5095H3BJ	225	315	
		'5110H3BJ	205	285	
	$f = 1\text{ MHz}$, $V_d = 1\text{ V rms}$, $V_D = -50\text{ V}$	'5115H3BJ	180	250	
		'5150H3BJ	120	170	
		'5190H3BJ	120	170	
		'5070H3BJ	90	125	
		'5080H3BJ	80	110	
$f = 1\text{ MHz}$, $V_d = 1\text{ V rms}$, $V_D = -100\text{ V}$	'5095H3BJ	73	100		
	'5110H3BJ	65	90		
	'5115H3BJ	56	80		
	'5150H3BJ	35	50		
$f = 1\text{ MHz}$, $V_d = 1\text{ V rms}$, $V_D = -100\text{ V}$	'5190H3BJ	35	50		
	'5150H3BJ	30	40		
$f = 1\text{ MHz}$, $V_d = 1\text{ V rms}$, $V_D = -100\text{ V}$	'5190H3BJ	30	40		
	'5150H3BJ	30	30		

NOTE: 6. Up to 10 MHz the capacitance is essentially independent of frequency. Above 10 MHz the effective capacitance is strongly dependent on connection inductance.

Thermal Characteristics, $T_A = 25\text{ }^\circ\text{C}$ (Unless Otherwise Noted)

Parameter	Test Conditions	Min	Typ	Max	Unit
$R_{\theta JA}$ Junction to ambient thermal resistance	EIA/JESD51-3 PCB, $I_T = I_{TSM(1000)}$ (see Note 7)			113	$^\circ\text{C/W}$
	265 mm x 210 mm populated line card, 4-layer PCB, $I_T = I_{TSM(1000)}$		50		

NOTE: 7. EIA/JESD51-2 environment and PCB has standard footprint dimensions connected with 5 A rated printed wiring track widths.

JANUARY 1998 – REVISED JULY 2019

Specifications are subject to change without notice.

Users should verify actual device performance in their specific applications.

The products described herein and this document are subject to specific legal disclaimers as set forth on the last page of this document, and at www.bourns.com/docs/legal/disclaimer.pdf.

Parameter Measurement Information

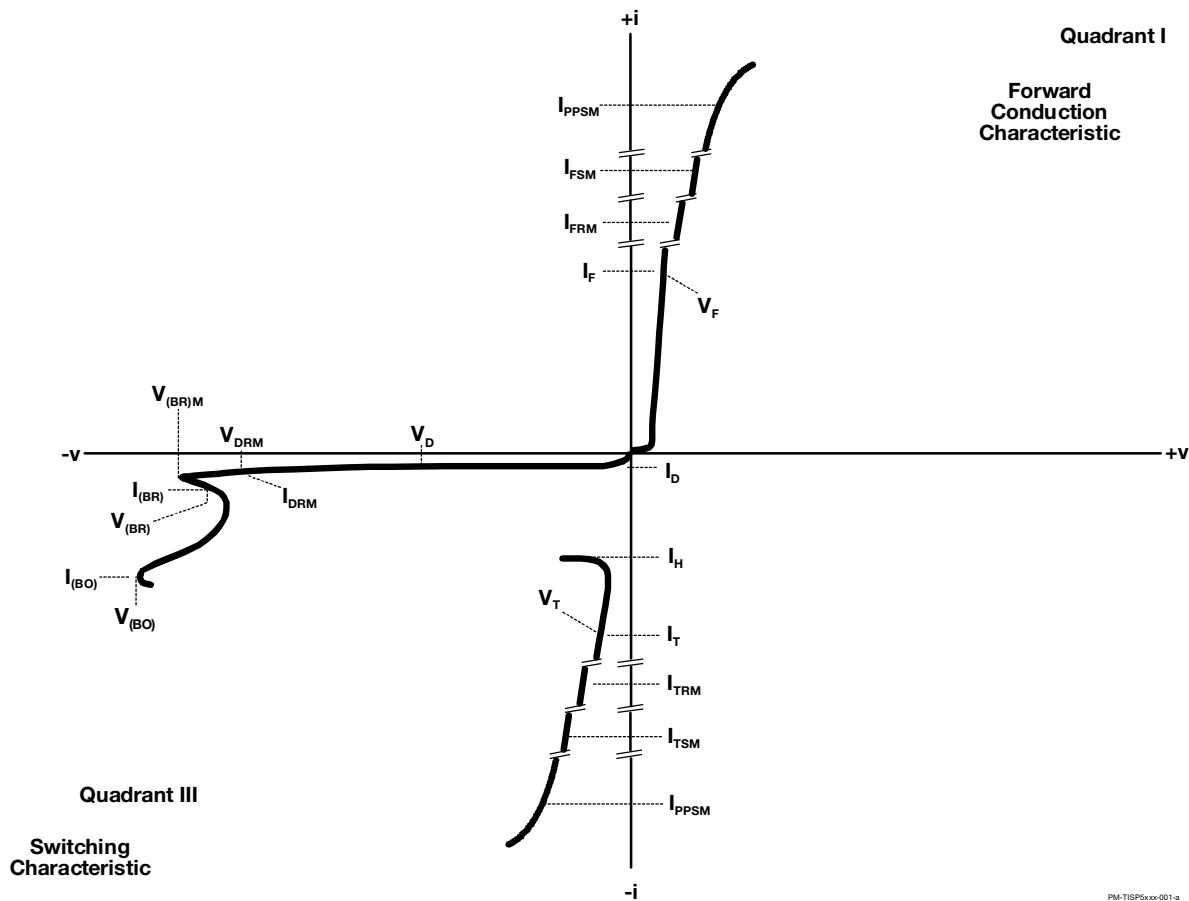

PM-TISP5xxx-001-a

Figure 1. Voltage-Current Characteristic for Terminal Pair
 All Measurements are Referenced to the Thyristor Anode, A (Pin 1)

Typical Characteristics

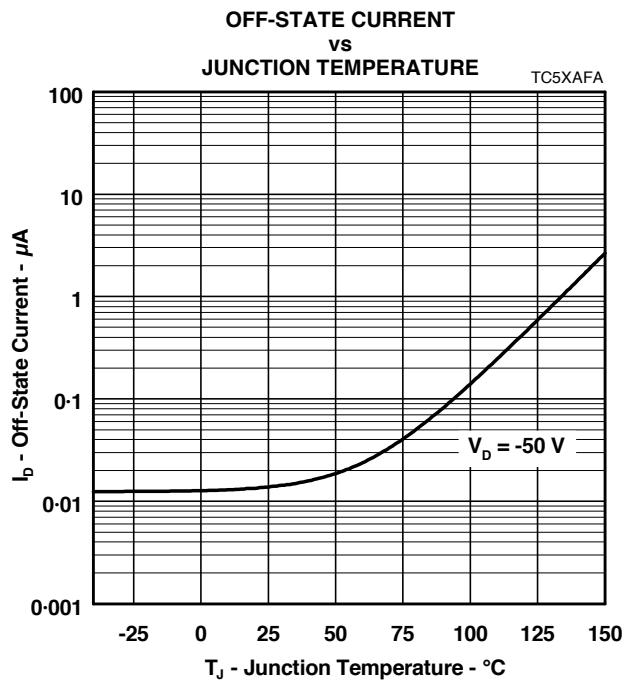

Figure 2.

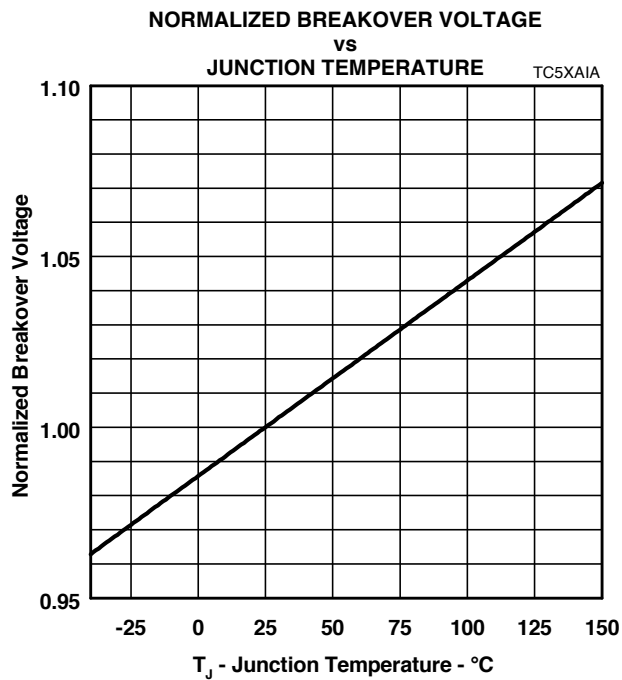

Figure 3.

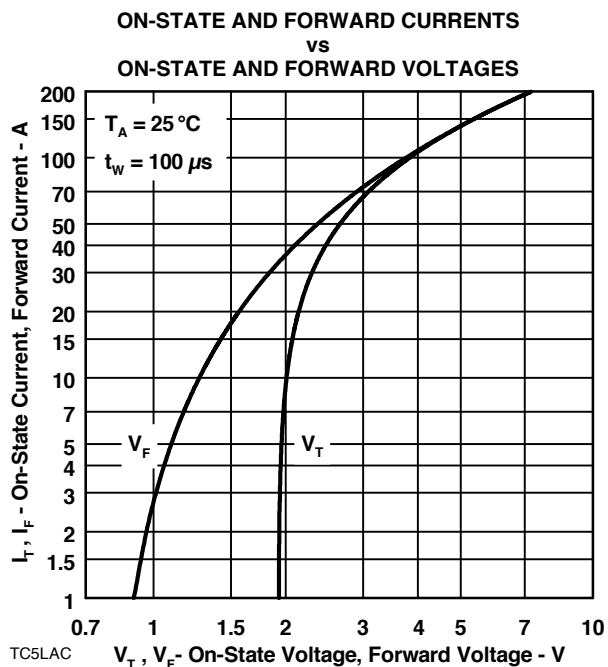

Figure 4.

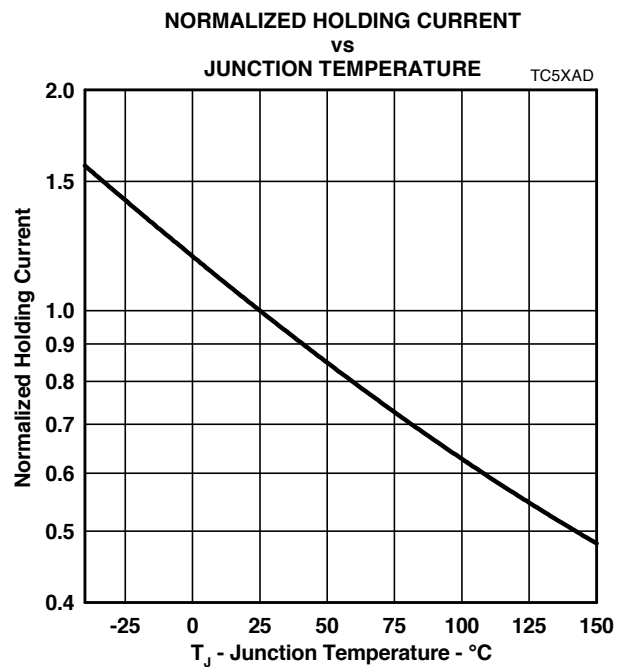

Figure 5.

JANUARY 1998 – REVISED JULY 2019

Specifications are subject to change without notice.

Users should verify actual device performance in their specific applications.

The products described herein and this document are subject to specific legal disclaimers as set forth on the last page of this document, and at www.bourns.com/docs/legal/disclaimer.pdf.

Typical Characteristics

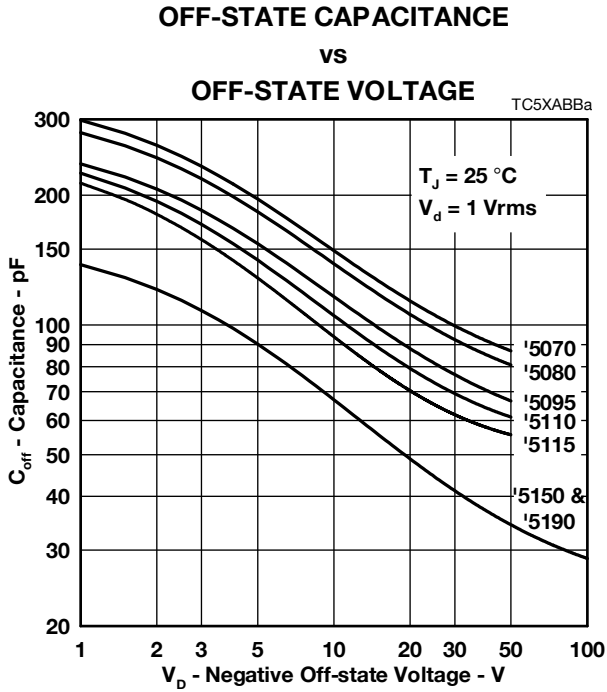

Figure 6.

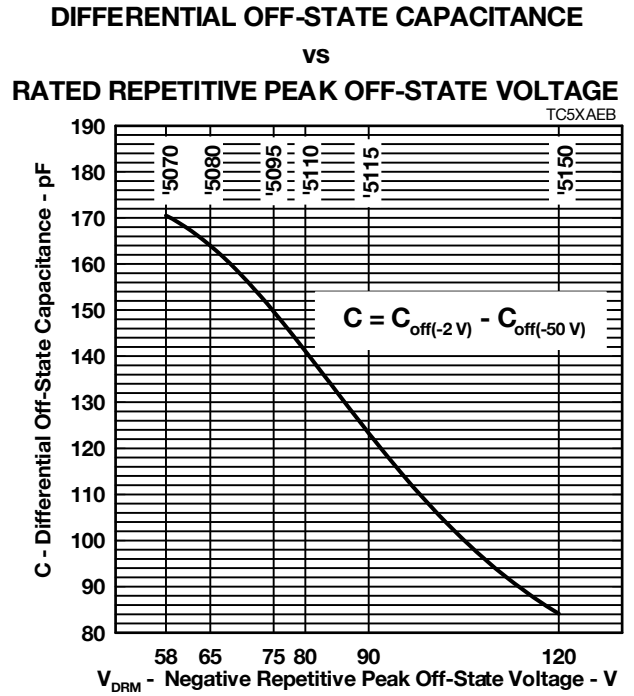
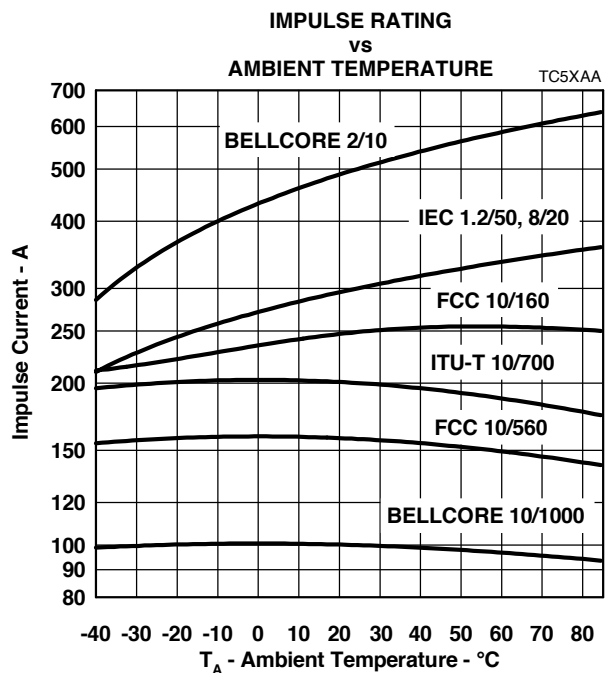
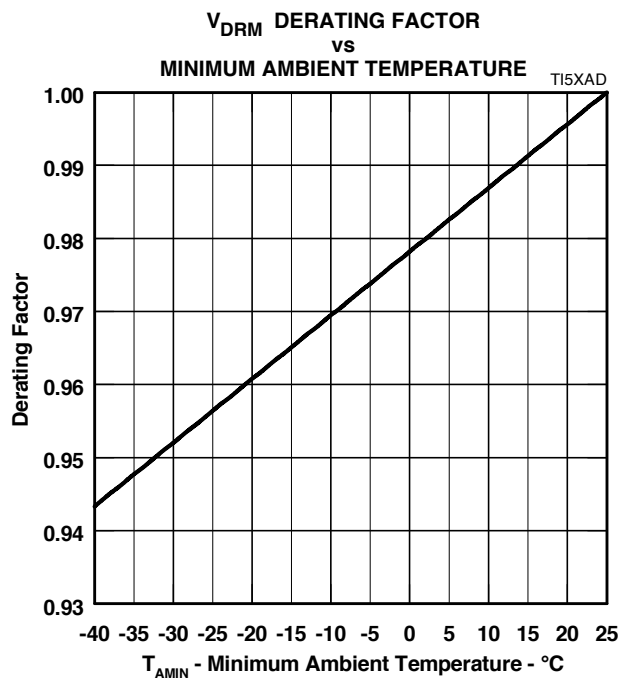
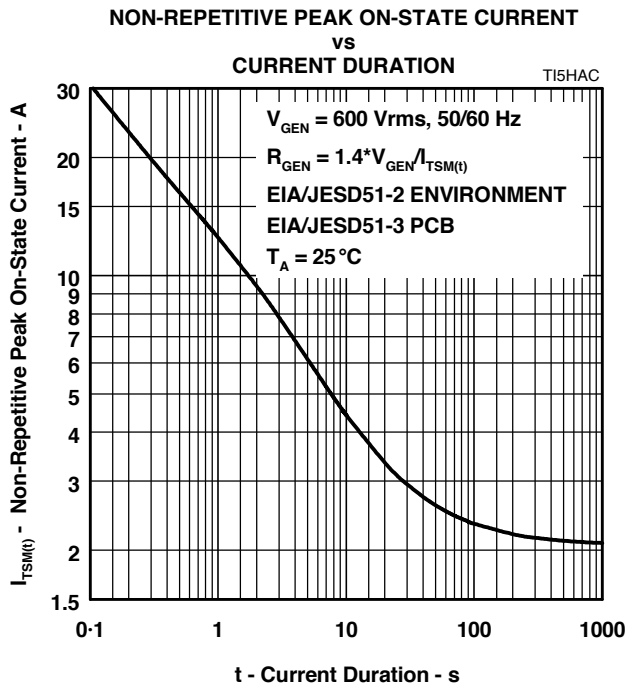

Figure 7.

Rating and Thermal Information



JANUARY 1998 – REVISED JULY 2019

Specifications are subject to change without notice.

Users should verify actual device performance in their specific applications.

The products described herein and this document are subject to specific legal disclaimers as set forth on the last page of this document, and at www.bourns.com/docs/legal/disclaimer.pdf.

APPLICATIONS INFORMATION

Deployment

These devices are two terminal overvoltage protectors. They may be used either singly to limit the voltage between two points (Figure 11) or in multiples to limit the voltage at several points in a circuit (Figure 12).

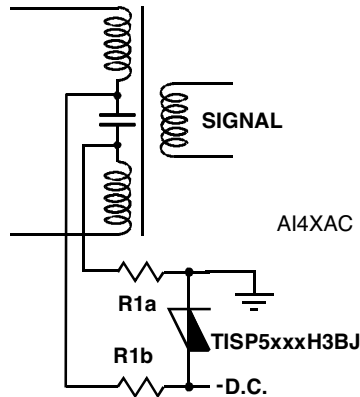

Figure 11. Power Supply Protection

In Figure 11, the TISP5xxxH3BJ limits the maximum voltage of the negative supply to $-V_{(BO)}$ and $+V_F$. This configuration can be used for protecting circuits where the voltage polarity does not reverse in normal operation. In Figure 12, the two TISP5xxxH3BJ protectors, Th4 and Th5, limit the maximum voltage of the SLIC (Subscriber Line Interface Circuit) outputs to $-V_{(BO)}$ and $+V_F$. Ring and test protection is given by protectors Th1, Th2 and Th3. Protectors Th1 and Th2 limit the maximum tip and ring wire voltages to the $\pm V_{(BO)}$ of the individual protector. Protector Th3 limits the maximum voltage between the two conductors to its $\pm V_{(BO)}$ value. If the equipment being protected has all its vulnerable components connected between the conductors and ground, then protector Th3 is not required.

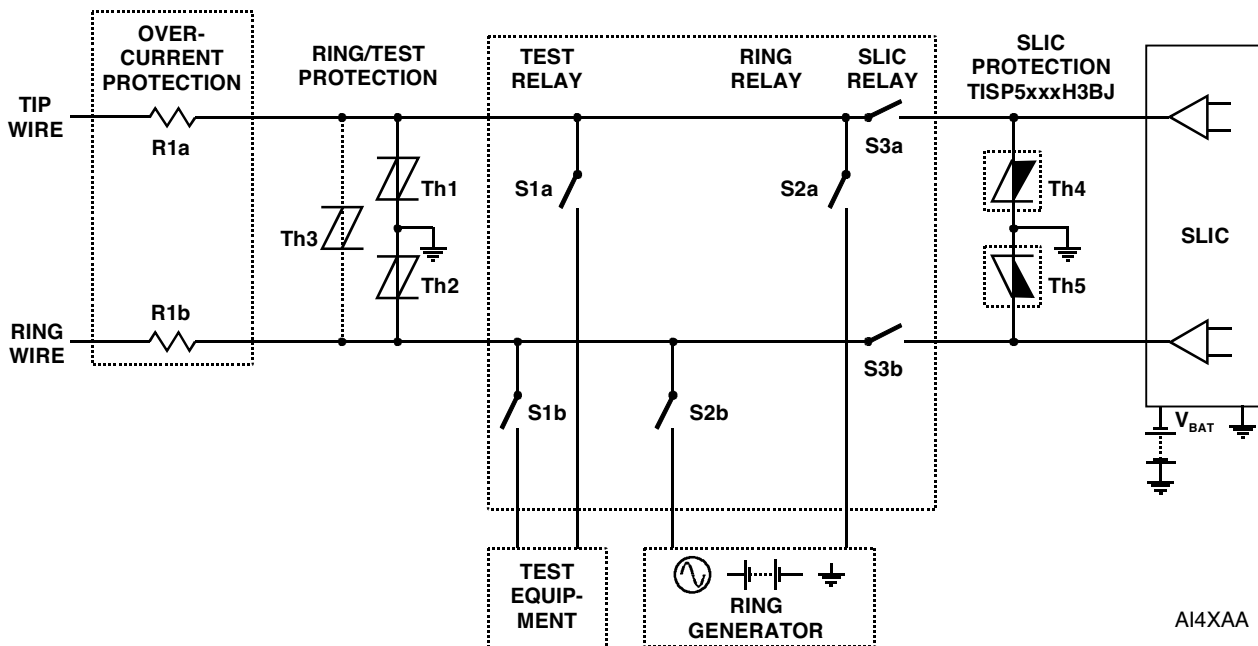

Figure 12. Line Card SLIC Protection

APPLICATIONS INFORMATION (CONTINUED)

The star-connection of three TISP5xxxH3BJ protectors gives a protection circuit which has a low differential capacitance to ground (Figure 13). This example, a -100 V ISDN line is protected. In Figure 13, the circuit illustration A shows that protector Th1 will be forward biased as it is connected to the most negative potential. The other two protectors, Th2 and Th3 will be reverse biased as protector Th1 will pull their common connection to within 0.5 V of the negative voltage supply.

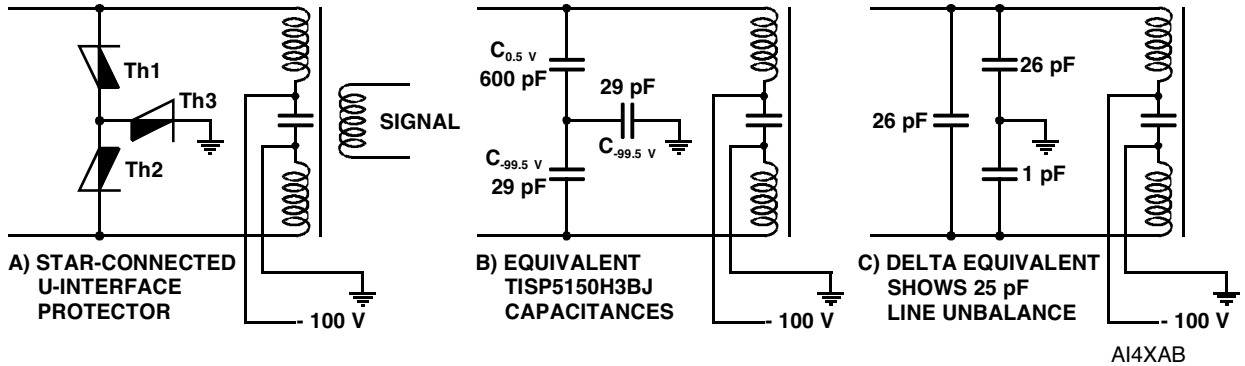

Figure 13. ISDN Low Capacitance U-Interface Protection

Illustration B shows the equivalent capacitances of the two reverse biased protectors (Th2 and Th3) as 29 pF each and the capacitance of the forward biased protector (Th1) as 600 pF. Illustration C shows the delta equivalent of the star capacitances of illustration B. The protector circuit differential capacitance will be $26 - 1 = 25$ pF. In this circuit, the differential capacitance value cannot exceed the capacitance value of the ground protector (Th3).

A bridge circuit can be used for low capacitance differential. Whatever the potential of the ring and tip conductors are in Figure 14, the array of steering diodes, D1 through to D6, ensure that terminal 1 of protector Th1 is always positive with respect to terminal 2. The protection voltage will be the sum of the protector Th1, $V_{(BO)}$, and the forward voltage of the appropriate series diodes. It is important to select the correct diodes. Diodes D3 through to D6 divert the currents from the ring and tip lines. Diodes D1 and D2 will carry the sum of the ring and tip currents and so conduct twice the current of the other four diodes. The diodes need to be specified for forward recovery voltage, V_{FRM} , under the expected impulse conditions. (Some conventional a.c. rectifiers can produce as much as 70 V of forward recovery voltage, which would be an extra 140 V added to the $V_{(BO)}$ of Th1). In principle the bridge circuit can be extended to protect more than two conductors by adding extra legs to the bridge.

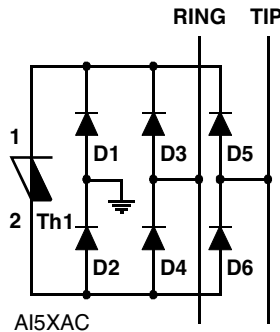

Figure 14. Low Capacitance Bridge Protection Circuit

APPLICATIONS INFORMATION

ISDN Device Selection

The ETSI Technical Report ETR 080:1993 defines several range values in terms of maximum and minimum ISDN feeding voltages. The following table shows that ranges 1 and 2 can use a TISP5110H3BJ protector and ranges 3 to 5 can use a TISP5150H3BJ protector.

Range	Feeding Voltage		Standoff Voltage V_{DRM} V	Device Name
	Minimum V	Maximum V		
1	51	69	-75	TISP5095H3BJ
2	66	70	-80	TISP5110H3BJ
3	91	99	-120	TISP5150H3BJ
4	90	110		
5	105	115		

Impulse Testing

To verify the withstand capability and safety of the equipment, standards require that the equipment is tested with various impulse wave forms. The table below shows some common values.

Standard	Peak Voltage Setting V	Voltage Waveshape μs	Peak Current Value A	Current Waveshape μs	TISP5xxxH3BJ 25 °C Rating A	Series Resistance Ω
GR-1089-CORE	2500	2/10	500	2/10	500	0
	1000	10/1000	100	10/1000	100	
TIA-968-A	1500	10/160	200	10/160	250	0
	800	10/560	100	10/560	160	0
	1500	9/720 †	37.5	5/320 †	200	0
	1000	9/720 †	25	5/320 †	200	0
I3124	1500	0.5/700	37.5	0.2/310	200	0
ITU-T K.20/21/45	1500	10/700	37.5	5/310	200	0
	4000		100			
	6000		150			

† TIA-968-A terminology for the waveforms produced by the ITU-T recommendation K.21 10/700 impulse generator.

If the impulse generator current exceeds the protector's current rating then a series resistance can be used to reduce the current to the protector's rated value and so prevent possible failure. The required value of series resistance for a given waveform is given by the following calculations. First, the minimum total circuit impedance is found by dividing the impulse generator's peak voltage by the protector's rated current. The impulse generator's fictive impedance (generator's peak voltage divided by peak short circuit current) is then subtracted from the minimum total circuit impedance to give the required value of series resistance. In some cases the equipment will require verification over a temperature range. By using the rated waveform values from Figure 10, the appropriate series resistor value can be calculated for ambient temperatures in the range of -40 °C to 85 °C.

If the devices are used in a star-connection, then the ground return protector, Th3 in Figure 13, will conduct the combined current of protectors Th1 and Th2. Similarly in the bridge connection (Figure 14), the protector Th1 must be rated for the sum of the conductor currents. In these cases, it may be necessary to include some series resistance in the conductor feed to reduce the impulse current to within the protector's ratings.

APPLICATIONS INFORMATION

AC Power Testing

The protector can withstand currents applied for times not exceeding those shown in Figure 8. Currents that exceed these times must be terminated or reduced to avoid protector failure. Fuses, PTC (Positive Temperature Coefficient) resistors and fusible resistors are overcurrent protection devices which can be used to reduce the current flow. Protective fuses may range from a few hundred milliamperes to one ampere. In some cases it may be necessary to add some extra series resistance to prevent the fuse opening during impulse testing. The current versus time characteristic of the overcurrent protector must be below the line shown in Figure 8. In some cases there may be a further time limit imposed by the test standard (e.g. UL 1459 wiring simulator failure).

Capacitance

The protector characteristic off-state capacitance values are given for d.c. bias voltage, V_D , values of -1 V, -2 V and -50 V. The TISP5150H3BJ and TISP5190H3BJ are also given for a bias of -100 V. Values for other voltages may be determined from Figure 6. Up to 10 MHz, the capacitance is essentially independent of frequency. Above 10 MHz, the effective capacitance is strongly dependent on connection inductance. In Figure 12, the typical conductor bias voltages will be about -2 V and -50 V. Figure 7 shows the differential (line unbalance) capacitance caused by biasing one protector at -2 V and the other at -50 V. For example, the TISP5070H3BJ has a differential capacitance value of 166 pF under these conditions.

Normal System Voltage Level

The protector should not clip or limit the voltages that occur in normal system operation. Figure 9 allows the calculation of the protector V_{DRM} value at temperatures below 25 °C. The calculated value should not be less than the maximum normal system voltages. The TISP5150H3BJ, with a V_{DRM} of -120 V, can be used to protect ISDN feed voltages having maximum values of -99 V, -110 V and -115 V (range 3 through to range 5). These three range voltages represent 0.83 (99/120), 0.92 (110/120) and 0.96 (115/120) of the -120 V TISP5150H3BJ V_{DRM} . Figure 9 shows that the V_{DRM} will have decreased to 0.944 of its 25 °C value at -40 °C. Thus, the supply feed voltages of -99 V (0.83) and -110 V (0.92) will not be clipped at temperatures down to -40 °C. The -115 V (0.96) feed supply may be clipped if the ambient temperature falls below -21 °C.

JESD51 Thermal Measurement Method

To standardize thermal measurements, the EIA (Electronic Industries Alliance) has created the JESD51 standard. Part 2 of the standard (JESD51-2, 1995) describes the test environment. This is a 0.0283 m³ (1 ft³) cube which contains the test PCB (Printed Circuit Board) horizontally mounted at the center. Part 3 of the standard (JESD51-3, 1996) defines two test PCBs for surface mount components; one for packages smaller than 27 mm on a side and the other for packages up to 48 mm. The SMB (DO-214AA) measurements used the smaller 76.2 mm x 114.3 mm (3.0" x 4.5") PCB. The JESD51-3 PCBs are designed to have low effective thermal conductivity (high thermal resistance) and represent a worse case condition. The PCBs used in the majority of applications will achieve lower values of thermal resistance and so can dissipate higher power levels than indicated by the JESD51 values.

BOURNS®

Asia-Pacific: Tel: +886-2 2562-4117 • Email: asiacus@bourns.com

Europe: Tel: +36 88 885 877 • Email: eurocus@bourns.com

The Americas: Tel: +1-951 781-5500 • Email: americus@bourns.com

www.bourns.com

JANUARY 1998 – REVISED JULY 2019

"TISP" is a trademark of Bourns, Ltd., a Bourns Company, and is registered in the U.S. Patent and Trademark Office. "Bourns" is a registered trademark of Bourns, Inc. in the U.S. and other countries.

Specifications are subject to change without notice.

Users should verify actual device performance in their specific applications.

The products described herein and this document are subject to specific legal disclaimers as set forth on the last page of this document, and at www.bourns.com/docs/legal/disclaimer.pdf.

This legal disclaimer applies to purchasers and users of Bourns® products manufactured by or on behalf of Bourns, Inc. and its affiliates (collectively, “Bourns”).

Unless otherwise expressly indicated in writing, Bourns® products and data sheets relating thereto are subject to change without notice. Users should check for and obtain the latest relevant information and verify that such information is current and complete before placing orders for Bourns® products.

The characteristics and parameters of a Bourns® product set forth in its data sheet are based on laboratory conditions, and statements regarding the suitability of products for certain types of applications are based on Bourns’ knowledge of typical requirements in generic applications. The characteristics and parameters of a Bourns® product in a user application may vary from the data sheet characteristics and parameters due to (i) the combination of the Bourns® product with other components in the user’s application, or (ii) the environment of the user application itself. The characteristics and parameters of a Bourns® product also can and do vary in different applications and actual performance may vary over time. Users should always verify the actual performance of the Bourns® product in their specific devices and applications, and make their own independent judgments regarding the amount of additional test margin to design into their device or application to compensate for differences between laboratory and real world conditions.

Unless Bourns has explicitly designated an individual Bourns® product as meeting the requirements of a particular industry standard (e.g., ISO/TS 16949) or a particular qualification (e.g., UL listed or recognized), Bourns is not responsible for any failure of an individual Bourns® product to meet the requirements of such industry standard or particular qualification. Users of Bourns® products are responsible for ensuring compliance with safety-related requirements and standards applicable to their devices or applications.

Bourns® products are not recommended, authorized or intended for use in nuclear, lifesaving, life-critical or life-sustaining applications, nor in any other applications where failure or malfunction may result in personal injury, death, or severe property or environmental damage. Unless expressly and specifically approved in writing by two authorized Bourns representatives on a case-by-case basis, use of any Bourns® products in such unauthorized applications might not be safe and thus is at the user’s sole risk. Life-critical applications include devices identified by the U.S. Food and Drug Administration as Class III devices and generally equivalent classifications outside of the United States.

Bourns expressly identifies those Bourns® standard products that are suitable for use in automotive applications on such products’ data sheets in the section entitled “Applications.” Unless expressly and specifically approved in writing by two authorized Bourns representatives on a case-by-case basis, use of any other Bourns® standard products in an automotive application might not be safe and thus is not recommended, authorized or intended and is at the user’s sole risk. If Bourns expressly identifies a sub-category of automotive application in the data sheet for its standard products (such as infotainment or lighting), such identification means that Bourns has reviewed its standard product and has determined that if such Bourns® standard product is considered for potential use in automotive applications, it should only be used in such sub-category of automotive applications. Any reference to Bourns® standard product in the data sheet as compliant with the AEC-Q standard or “automotive grade” does not by itself mean that Bourns has approved such product for use in an automotive application.

Bourns® standard products are not tested to comply with United States Federal Aviation Administration standards generally or any other generally equivalent governmental organization standard applicable to products designed or manufactured for use in aircraft or space applications. Bourns expressly identifies Bourns® standard products that are suitable for use in aircraft or space applications on such products’ data sheets in the section entitled “Applications.” Unless expressly and specifically approved in writing by two authorized Bourns representatives on a case-by-case basis, use of any other Bourns® standard product in an aircraft or space application might not be safe and thus is not recommended, authorized or intended and is at the user’s sole risk.

The use and level of testing applicable to Bourns® custom products shall be negotiated on a case-by-case basis by Bourns and the user for which such Bourns® custom products are specially designed. Absent a written agreement between Bourns and the user regarding the use and level of such testing, the above provisions applicable to Bourns® standard products shall also apply to such Bourns® custom products.

Users shall not sell, transfer, export or re-export any Bourns® products or technology for use in activities which involve the design, development, production, use or stockpiling of nuclear, chemical or biological weapons or missiles, nor shall they use Bourns® products or technology in any facility which engages in activities relating to such devices. The foregoing restrictions apply to all uses and applications that violate national or international prohibitions, including embargos or international regulations. Further, Bourns® products and Bourns technology and technical data may not under any circumstance be exported or re-exported to countries subject to international sanctions or embargoes. Bourns® products may not, without prior authorization from Bourns and/or the U.S. Government, be resold, transferred, or re-exported to any party not eligible to receive U.S. commodities, software, and technical data.

To the maximum extent permitted by applicable law, Bourns disclaims (i) any and all liability for special, punitive, consequential, incidental or indirect damages or lost revenues or lost profits, and (ii) any and all implied warranties, including implied warranties of fitness for particular purpose, non-infringement and merchantability.

For your convenience, copies of this Legal Disclaimer Notice with German, Spanish, Japanese, Traditional Chinese and Simplified Chinese bilingual versions are available at:

Web Page: <http://www.bourns.com/legal/disclaimers-terms-and-policies>

PDF: <http://www.bourns.com/docs/Legal/disclaimer.pdf>

X-ON Electronics

Largest Supplier of Electrical and Electronic Components

Click to view similar products for [Thyristor Surge Protection Devices - TSPD category](#):

Click to view products by [Bourns manufacturer](#):

Other Similar products are found below :

[BEP3100TA](#) [P0720SB](#) [P0720SC](#) [P1100SC](#) [P2300SB](#) [P2300SD](#) [P2600SB](#) [P3500SB](#) [SKKH 57/16E](#) [SKKH 72/22E H4](#) [SKKH 72/08E](#)
[NP1100SAT3G](#) [NP3100SBT3G](#) [SK20NHMH10](#) [P3800FNLTP](#) [TISP4P035L1NR-S](#) [TISP4011H1BJR-S](#) [SKKH 72/20E H4](#) [SKKH92/16E](#)
[SKKH 172/16E](#) [TISP4350H3BJR-S](#) [TISP4A265H3BJR](#) [TISP7082F3DR-S](#) [TB0640H-13-F](#) [TB3100H-13-F](#) [TB3100M-13-F](#) [TB3500L-13-F](#)
[TD330N16KOFHPSA2](#) [P0080EAL](#) [P0080ECL](#) [P0080Q22CLRP](#) [P0080S3NLRP](#) [P0080SALRP](#) [P0080SAMCLRP](#) [P0080SB](#) [P0080SBLRP](#)
[P0080SCLRP](#) [P0080SCMCLRP](#) [P0080SDLRP](#) [P3203UCLRP](#) [P0220SALRP](#) [P0220SCMCLRP](#) [P0300EAL](#) [P0300SALRP](#) [P0300SBLRP](#)
[P0300SCLRP](#) [P0300SCMCLRP](#) [P3100Q12BLRP](#) [P0640SALRP](#) [P0640SBLRP](#)