

承 认 书
SPECIFICATION FOR APPROVAL

客 户Customer: _____

产品名称Project: FPC排线 _____

规格型号Part No: AB03A0100000170A _____

贵公司承认印 Approval signatures

料 号/Part No.	签 章/Signatures

Send us a copy of reference, thank you!

日期 Date:

地址: 浙江省乐清市虹桥镇仙垟陈工业区
Add: Xianyangchen Industry Zone Hongqiao
Yueqing Zhejiang
电话/Tel: 86-0577-57573366
传真/Fax: 86-0577-57573373
Http://www.cnbozhong.com
Alibaba: Http://dezhimei.cn.alibaba.com

拟制/Drawn	赵晓峰
审核/Check	陈东峰
批准/Approved	朱旭静

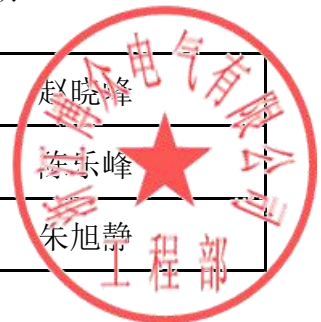

MATERIAL SPECIFICATION

PRODUCT	FLEXIBLE FLAT CABLE					
UL STYLE NO.	VOLTAGE RATING	OPERATING TEMPERATURE	UL FILE NO.	MARKING		
<input type="checkbox"/> AWM 2896	30V	80°C		AWM 2896 80°C VW-1		
<input checked="" type="checkbox"/> AWM 20624	60V	80°C		AWM 20624 80°C VW-1		
<input type="checkbox"/> AWM 20706	60V	105°C		AWM 20706 105°C VW-1		
CONDUCTOR	SIZE (Ct×Cw)	RATED CURRENT	RESISTANCE	REMARKS		
	<input type="checkbox"/> 0.1X1.27	2A	0.17Ω/M	* TIN PLATED COPPER WIRE		
	<input type="checkbox"/> 0.1X0.8	2A	0.27Ω/M	: 99.994% PURE COPPER		
	<input type="checkbox"/> 0.1X0.7	2A	0.33Ω/M	* TOLERANCE OF THICKNESS		
	<input type="checkbox"/> 0.1X0.65	2A	0.35Ω/M	: ±0.005		
	<input type="checkbox"/> 0.1X0.5	1A	0.42Ω/M	* TOLERANCE OF WIDTH		
	<input type="checkbox"/> 0.1X0.3	1A	0.70Ω/M	: ±0.03		
	<input type="checkbox"/> 0.05X0.8	1A	0.53Ω/M	* EXTENSION RATE		
	<input type="checkbox"/> 0.05X0.65	1A	0.63Ω/M	: OVER THAN 15%		
	<input type="checkbox"/> 0.05X0.6	1A	0.65Ω/M	* STRAIN STRENGTH		
	<input type="checkbox"/> 0.035X0.8	1A	0.83Ω/M	: OVER THAN 13Kgf/mm ²		
	<input type="checkbox"/> 0.035X0.7	1A	0.60Ω/M	* PLATING THICKNESS		
	<input type="checkbox"/> 0.035X0.65	1A	0.96Ω/M	: 0.075 μ 以上		
	<input checked="" type="checkbox"/> 0.035X0.3	0.5A	1.89Ω/M			
	<input type="checkbox"/> 0.022X0.32	0.5A	3.18Ω/M			
	<input type="checkbox"/> 0.1X0.5 (PBW)	0.5A	2.80Ω/M	* TIN PLATED PHOSPHORUS BRONZE WIRE		
LEAD FREE <input checked="" type="checkbox"/>			GOLD <input type="checkbox"/>			
INSULATION FILM	NO.	BASE FILM	ADHESIVE	TOTAL THICKNESS	REMARK	COLOR
	<input type="checkbox"/> 1	PET 25μm	35μm	60μm	REGULAR	<input type="checkbox"/> WHITE <input type="checkbox"/> BLACK
	<input checked="" type="checkbox"/> 2	PET 19μm	24μm	43μm	SUPER FLEX	<input checked="" type="checkbox"/> WHITE
	<input type="checkbox"/> 3	PET 12μm	25μm	37μm	ULTRA FLEX	<input type="checkbox"/> WHITE
DECA FREE <input type="checkbox"/>						
SUPPORTING TAPE	NO.	BASE FILM	ADHESIVE	TOTAL THICKNESS	COLOR	
	<input type="checkbox"/> 1	PET 125μm	35μm	160μm	<input type="checkbox"/> WHITE	<input type="checkbox"/> BLUE
	<input checked="" type="checkbox"/> 2	PET 190μm	35μm	225μm	<input type="checkbox"/> WHITE	<input checked="" type="checkbox"/> BLUE
	<input type="checkbox"/> 3	PET 215μm	35μm	250μm	<input type="checkbox"/> WHITE	<input type="checkbox"/> BLUE
<input type="checkbox"/> 4	PET 250μm	35μm	285μm	<input type="checkbox"/> WHITE	<input type="checkbox"/> BLUE	
EMI SHIELD	ALUMINIUM FOIL [um] COPPER FOIL [um] FABRIC TAPE [um] LAMINATION [um]					
DOUBLE SIDE TAPE						
DIELECTRIC VOLTAGE WITHSTAND TEST			AC 500V/10mA 1分钟			
INSULATION RESISTANCE TEST			DC 500V/100Ω/M			
AGING			85°C/96 HR			
FLEXIBILITY	GENERAL	10,000 Min (R5×240/Min×40mm/Reciprocating)				
	FLEX	100,000 Min (R5×240/Min×40mm/Reciprocating)				
	SUPER	3,000,000 Min (R5×240/Min×40mm/Reciprocating)				
	ULTRA	6,000,000 Min (R5×240/Min×40mm/Reciprocating)				
FLAMMABILITY		PASS UL VW-1				

Matters that demand special attention :

- * When insert to connector, please insert straight correctly with Joiner's supporting-tape.

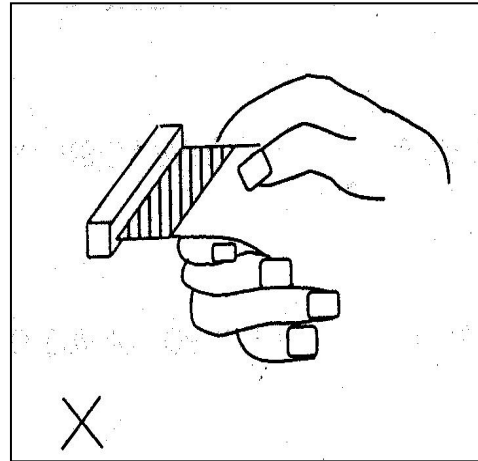
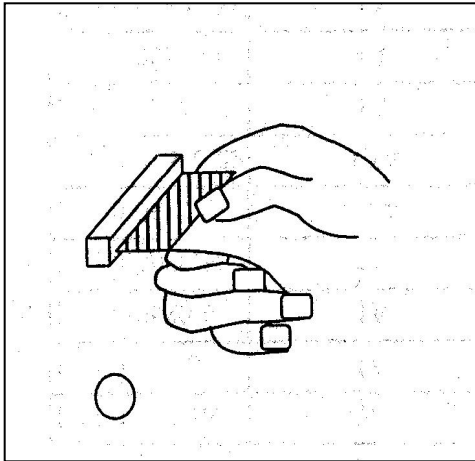

- * When insert to connector, please avoid excessive force.

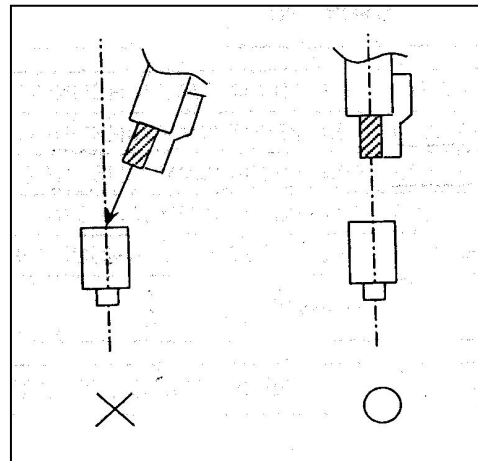
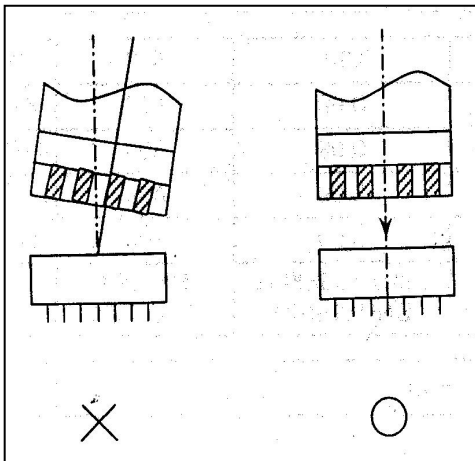

- * After insert to connector, shall be not bend at supporting-tape excessive because Joiner is broken

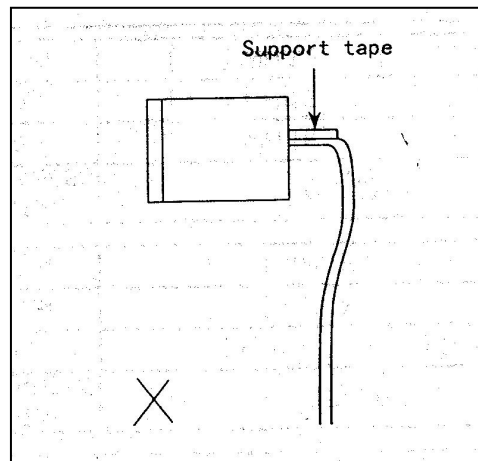
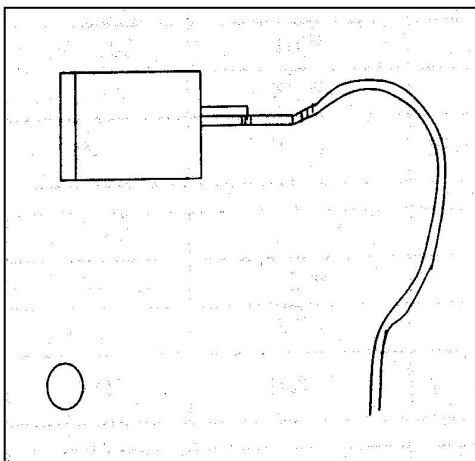

X-ON Electronics

Largest Supplier of Electrical and Electronic Components

Click to view similar products for [FFC / FPC Jumper Cables](#) category:

Click to view products by [Bozhong Electric](#) manufacturer:

Other Similar products are found below :

[8-1474659-7](#) [FSK-21.5A-20](#) [FSK-23A](#) [FSN-14.5A-6](#) [1474494-5](#) [1557385-1](#) [2-1437211-4](#) [2-6447164-4](#) [1-6437133-3](#) [FSK-21A](#) [FSN-21.5A-32](#) [FSN-24A](#) [2-1437181-9](#) [4-1437186-9](#) [4-1474659-8](#) [5-1474654-9](#) [6-6437158-0](#) [1474544-1](#) [7-6474640-3](#) [8-1474644-8](#) [FSK-22Z-12](#) [1437190-1](#) [2-6437158-6](#) [3-1437213-7](#) [FSK-11.25A-40](#) [FSN-11A-10](#) [FSP-22A](#) [FST-41B-5](#) [1-1437203-7](#) [6447164-6](#) [1474678-7](#) [3-1437219-8](#) [FSK-11.1A-40](#) [FSN-11.5A-3](#) [1437219-2](#) [05-001-152FB](#) [05-001.5-152FB](#) [7-1437166-1](#) [5-1474677-4](#) [3-1447175-2](#) [4-6447189-2](#) [15020-1538](#) [FSK-21.3A-25](#) [07-004.5-172-P](#) [JS05B-12P-030-3-4](#) [JS05A-16P-080-4-8](#) [JS05A-12P-050-3-4](#) [JS05A-16P-100-3-4](#) [JS05A-12P-100-3-4](#) [JS05A-12P-030-3-4](#)