

TSC003*****

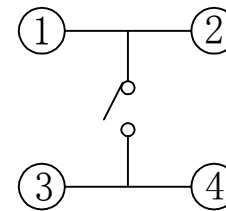

电路图
CIRCUIT DIAGRAM

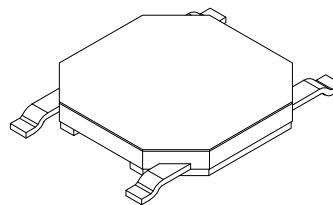
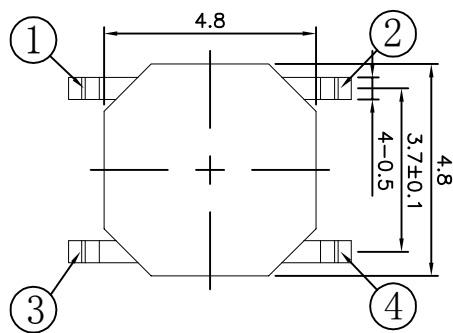
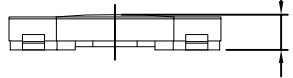
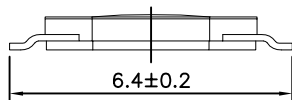
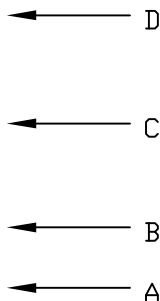
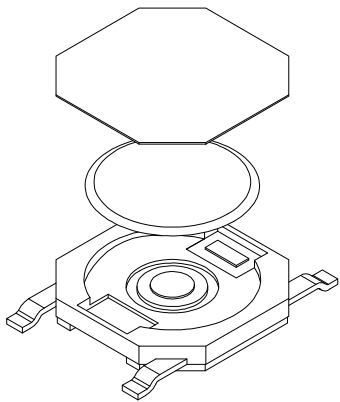
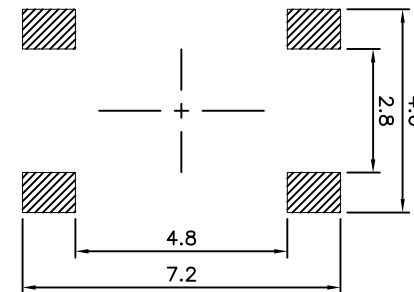

PCB. 焊接图
PCB. WELDING DRAWING

主要技术参数、性能
The Main Thchnology Performance

额定电流、电压 Rate voltage,current	50mA DC12V
接触电阻 Contact resistance	≤100mΩ
按力 Operating force	±50gf
行程 Travel	0.20±0.10mm
绝缘电阻 Insulated resistance	≥100MΩ
介电强度 Dielectric strength	≥250VAC/1min

T S C 0 0 3

寿命:
A: ≥100000次
B: ≥200000次
C: ≥300000次

高度H:
08:0.8H

力度:
18:180g
26:260g

包装方式:
A:散件
B:冷封编带
C:热封编带

D	防尘膜	聚酰亚胺	1	橙黄色
C	弹片	不锈钢	1	镀银
B	本体	PPA	1	黑色
A	卡件	黄铜	1	镀银
项目 ITEM	名称 DESCRIPTION	材质 MATERIAL	数量 QTY	表面处理/颜色 FINISH/COLOR

					第一视角 FIRST VIEW		名称/NAME: 轻触开关 TACTILE SWITCH	
							型号/MODEL: TSC003*****	
标记 SING	处数 FREQUENCY	更改文件号 REVISION	签名 APPROVED	日期 DATE	比例 SCALE	1:1	一般公差 GENERAL TOLERANCE	
设计 DESIGN		朱元隆		2021.06.01	单位 UNIT	mm	≥0~2<	±0.10
审核 CHECKED		赵晓峰		2021.06.01	重量 WEIGHT		≥2~5<	±0.25
批准 APPROVED		陈乐峰		2021.06.01			≥5	±0.30
					角度 ANGLE			±0.5°

BZCN 浙江博众电气有限公司
ZHEJIANG BOZHONG ELECTRONIC CO., LTD.

X-ON Electronics

Largest Supplier of Electrical and Electronic Components

Click to view similar products for [Tactile Switches](#) category:

Click to view products by [Bozhong Electric](#) manufacturer:

Other Similar products are found below :

[5GTH92001](#) [5GTH9202242](#) [6407-250V-25273P](#) [ADTSA62NV](#) [ADTSA62RV](#) [B3F-3123](#) [1977177-8](#) [1977266-1](#) [ADTSA63NV](#)
[ADTSM21NSVTR](#) [ADTSM25RVTR](#) [ADTSM32NVTR](#) [ADTSMW64RV](#) [FSMRA4JHA04](#) [GS4.70F300QP](#) [KSC241J SP DELTA LFS](#)
[3FTL600RAS](#) [3FTL640RAS](#) [Y96K132V0FPLFS](#) [5GTH9658222](#) [6407-250V-25343P](#) [ADTSM31NVTR](#) [2-1977120-7](#) [TSJW-5.2-260-TR](#)
[KMT011MNGJLHS](#) [B3WN6002S](#) [70-201.0](#) [ADTSG648NV](#) [ADTSM62KSVTR](#) [ADTSM648NV](#) [95C06E3RAT](#) [5GTH96561](#) [3ATH9Q](#)
[FSMRA8JHA04](#) [HARS0073](#) [Y97HS12A5RAFP](#) [Y97BT23B2HAFP](#) [Y33R411N9FPLFT](#) [Y31C01402FPLFS](#) [PTS645SK50SMTR92](#)
[ADTSM32NVB](#) [KMS233GPWTLFG](#) [Y78B64124FP](#) [PTS638SK25SMTR2LFS](#) [Y96D113G0FP LFS](#) [Y33A812C5FP LFT](#) [Y56B2D120FP](#)
[LFS](#) [PTS645 DVM83-BN125-2 LFS](#) [B3W 1000G](#) [KSC621G OL LFS](#)